

HOW TO REJUVENATE
ANTIQUE RADIOS

\$1.50 MAR. 1983

U.K. 85p

DGS

Radio- Electronics®

COMPUTERS - VIDEO - STEREO - TECHNOLOGY - SERVICE

Portable
SHORTWAVE RECEIVER

Buyers guide

Inside the new
767 COCKPIT

Build an
ACTIVE ANTENNA
for your VLF receiver

Back-to-school series
POWER AMPLIFIERS

Inexpensive and versatile
2 DVM CIRCUITS
you can build

PLUS:

- ★ Videogames ★ Hobby Corner
- ★ Computer Corner ★ Drawing Board
- ★ State-Of-Solid-State ★ Equipment Reports

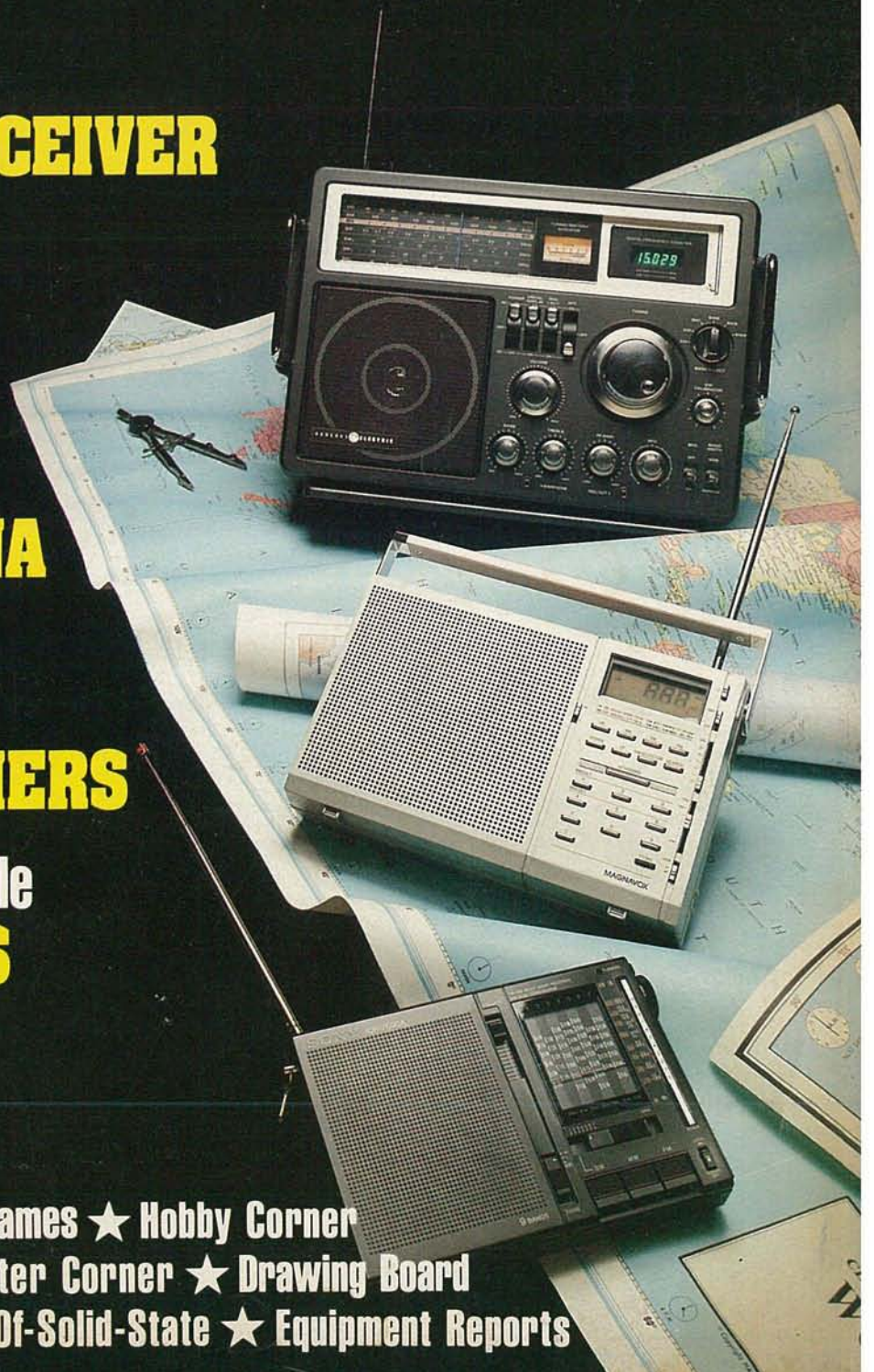



SOFT TOUCH
FULL-LOGIC
CONTROLS



CALIBRATED
DELAYED SWEEP



4 VERTICAL
INPUT CHANNELS



DUAL TIME BASE

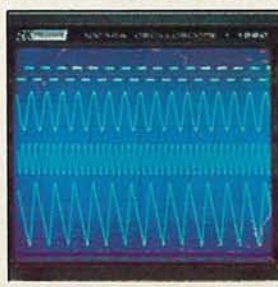
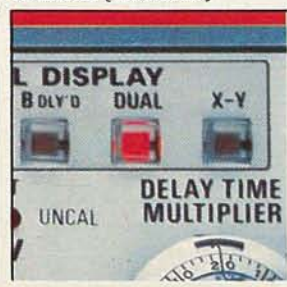

EXCLUSIVE
V MODE

8-TRACE DISPLAY

SWITCHABLE
INPUT IMPEDANCE [1590 ONLY]

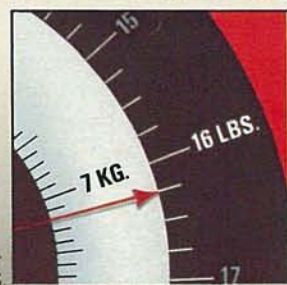

LIGHT WEIGHT
16.25 LBS.

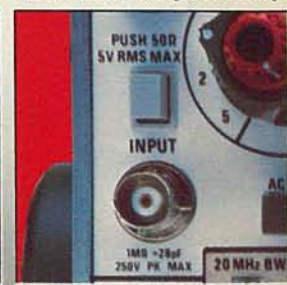
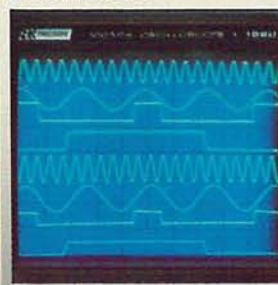
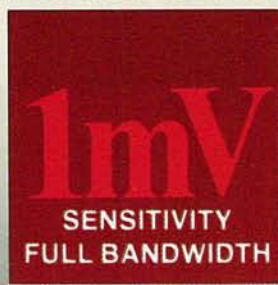

Looking for a 70 or 100MHz scope? B&K-PRECISION just eliminated the competition.

100MHz 1590
\$1995



70MHz 1570
\$1395

To learn more about how
B&K-PRECISION has eliminated the competition,
see your local distributor or call toll-free
1-800-621-4627 [in Illinois 1-312-889-9087].
Available for immediate delivery or 10 day free trial.

BKPRECISION DYNASCAN
CORPORATION

6460 West Cortland Street • Chicago, Illinois 60635 • 312/889-9087

Intl. Sis., 6460 W. Cortland St., Chicago, IL 60635

Canadian Sales, Atlas Electronics, Ontario

South and Central American Sales, Empire Exporters, Plainview, NY 11803

CIRCLE 78 ON FREE INFORMATION CARD

Cut Your Service Time Absolutely In Half Or Your Money Back.

Sencore SC61 60 MHz Waveform Analyzer

If you use a general purpose oscilloscope for troubleshooting we can cut your present service time in half with the SC61 Waveform Analyzer.

It's ten times faster—ten times more accurate: The SC61 is the first and only instrument to integrate the speed and accuracy of a digital readout with the viewing capability of a high performance 60 MHz scope. Connect only one probe and you can view any waveform to 60 MHz. Then, just push a button to read DCV, PPV, frequency and time.

There are no gratitudes to count or calculations to make so every measurement is 10 to 100 times faster than before.

The digital read-out is 10 to 10,000 times more accurate than conventional

scopes as well, for measurements you can trust in today's high precision circuits.

Plus having everything you want to know about a test point, at the push of a button, eliminates guesswork and backtracking

A special Delta function even lets you intensify any part of a waveform and digitally measure the PPV, time or frequency for just that waveform section. This really speeds VCR alignment and calibration procedures.

And it's neat: No more tangled

leads, piles of probes or dangling cords. The SC61 is an entire service bench in one unit. You can't get neater than that.

Cut your service time in half:

When we say the SC61 will cut your service time in half, we're being conservative. We know of cases where the SC61 has saved much more time than that. Every situation is different, however, so try an SC61 and judge for yourself. Here's our offer.

Money back guarantee: If the SC61 does not at least cut your present service time in half during the first thirty days, you may return it for a full refund, including freight both ways.

Call today. Get the entire SC61 Waveform Analyzer story. Call toll-free today, and ask for our eight page color brochure. It could be the most time-saving call you make this year!



\$3275

SENCORE
3200 Sencore Drive, Sioux Falls, SD 57107

Phone Toll-Free 800-843-3338
Alaska, Hawaii, Canada and SD call collect at (605) 339-0100

CIRCLE 6 ON FREE INFORMATION CARD
CIRCLE 89 FOR DEMONSTRATION

wabash[®] diskettes for as low as \$1.39 each!

Now...Get High Quality at a Low Price

Wabash means quality products that you can depend on. For over 16 years, Wabash has been making high quality computer products. Wabash diskettes are made to provide error-free performance on your computer system. Every Wabash diskette is individually tested and is 100% certified to insure premium performance.

Why Wabash is Special

The quality of Wabash diskettes is stressed throughout the entire manufacturing process. After coating, all Wabash diskettes go through a unique burnishing process that gives each diskette a mirror-smooth appearance. Wabash then carefully applies a lubricant that is specially formulated to increase diskette life. This saves you money, since your discs may last longer. It also assists your disk drives in maintaining constant speed which can reduce read and write errors.

Special Seal...Helps Prevent Contamination

To keep out foreign particles, a unique heat seal bonds the jacket and liner together. A special thermal seal which avoids contamination from adhesives, is then used to fold and seal the jacket. This results in outstanding performance and true reliability. Wabash then packages each diskette, (except bulk pack) in a super strong and tear resistant Tyvek[®] envelope. The final Wabash product is then shrink-wrapped to insure cleanliness and reduce contamination during shipment.

Each Diskette is 100% Critically Tested

Since each step in the Wabash diskette manufacturing process is subject to strict quality control procedures, you can be sure Wabash diskettes will perform for you. And every Wabash diskette meets the ultra-high standards of ANSI, ECMA, IBM and ISO in addition to the many critical quality control tests performed by Wabash. Wabash does all of this testing to provide you with consistently high quality diskettes. Reliability and data integrity - that's what Wabash quality is all about.

Flexible Disc Quantity Discounts Available

Wabash diskettes are packed 10 discs to a carton and 10 cartons to a case. The economy bulk pack is packaged 100 discs to a case without envelopes or labels. Please order only in increments of 100 units for quantity 100 pricing. With the exception of bulk pack, we are also willing to accommodate your smaller orders. Quantities less than 100 units are available in increments of 10 units at a 10% surcharge. **Quantity discounts** are also available. Order 500 or more discs at the same time and deduct 1%; 1,000 or more saves you 2%; 2,000 or more saves you 3%; 5,000 or more saves you 4%; 10,000 or more saves you 5%; 25,000 or more saves you 6%; 50,000 or more saves you 7% and 100,000 or more discs earns you an 8% discount off our super low quantity 100 price. Almost all Wabash diskettes are immediately available from CE. Our warehouse facilities are equipped to help us get you the quality product you need, when you need it. If you need further assistance to find the flexible disc that's right for you, call the Wabash diskette compatibility hotline. Dial toll-free 800-323-9868 and ask for your compatibility representative. In Illinois or outside the United States dial 312-593-6363 between 9 AM to 4 PM Central Time.

SAVE ON WABASH DISKETTES

| Product Description | Part # | CE quant. 100 price per disc (\$) |
|--|--------|---|
| 8" SSSD IBM Compatible (128 B/S, 26 Sectors) | F111 | 1.99 |
| 8" Same as above, but bulk pack w/o envelope | F111B | 1.79 |
| 8" SSSD Shugart Compatible, 32 Hard Sector | F31A | 1.99 |
| 8" SSDD IBM Compatible (128 B/S, 26 Sectors) | F131 | 2.49 |
| 8" DSDD Soft Sector (Unformatted) | F14A | 3.19 |
| 8" DSDD Soft Sector (256 B/S, 26 Sectors) | F144 | 3.19 |
| 3" DSDD Soft Sector (512 B/S, 15 Sectors) | F145 | 3.19 |
| 8" DSDD Soft Sector (1024 B/S, 8 Sectors) | F147 | 3.19 |
| 5 1/4" SSSD Soft Sector w/Hub Ring | M11A | 1.59 |
| 5 1/4" Same as above, but bulk pack w/o envelope | M11AB | 1.39 |
| 5 1/4" SSSD 10 Hard Sector w/Hub Ring | M41A | 1.59 |
| 5 1/4" SSSD 16 Hard Sector w/Hub Ring | M51A | 1.59 |
| 5 1/4" SSDD Lanier No-problem compatible | M51F | 2.99 |
| 5 1/4" SSDD Soft Sector w/Hub Ring | M13A | 1.89 |
| 5 1/4" Same as above, but bulk pack w/o envelope | M13AB | 1.69 |
| 5 1/4" SSDD Soft Sector Flippy Disk (use both sides) | M18A | 2.79 |
| 5 1/4" SSDD 10 Hard Sector w/Hub Ring | M43A | 1.89 |
| 5 1/4" SSDD 16 Hard Sector w/Hub Ring | M53A | 1.89 |
| 5 1/4" DSDD Soft Sector w/Hub Ring | M14A | 2.79 |
| 5 1/4" DSDD 10 Hard Sector w/Hub Ring | M44A | 2.79 |
| 5 1/4" DSDD 16 Hard Sector w/Hub Ring | M54A | 2.79 |
| 5 1/4" SSQD Soft Sector w/Hub Ring (96 TPI) | M15A | 2.69 |
| 5 1/4" DSQD Soft Sector w/Hub Ring (96 TPI) | M16A | 3.79 |

SSSD = Single Sided Single Density; SSDD = Single Sided Double Density; DSSD = Double Sided Double Density; SSQD = Single Sided Quad Density; DSQD = Double Sided Quad Density; TPI = Tracks per inch.

Buy with Confidence

To get the fastest delivery from CE of your Wabash computer products, send or phone your order directly to our Computer Products Division. Be sure to calculate your price using the CE prices in this ad. Michigan residents please add 4% sales tax or supply your tax I.D. number. Written purchase orders are accepted from approved government agencies and most well rated firms at a 30% surcharge for net 30 billing. All sales are subject to availability, acceptance and verification. All sales are final. Prices, terms and specifications are subject to change without notice. All prices are in U.S. dollars. Out of stock items will be placed on backorder automatically unless CE is instructed differently. Minimum *prepaid* order \$50.00. Minimum *purchase* order \$200.00. International orders are invited with a \$20.00 surcharge for special handling in addition to shipping charges. All shipments are F.O.B. Ann Arbor, Michigan. No COD's please. Non-certified and foreign checks require bank clearance.

For **shipping charges** add \$8.00 per case or partial-case of 100 8-inch discs or \$6.00 per case or partial-case of 100 5 1/4-inch mini-discs for U.P.S. ground shipping and handling in the continental United States.

Mail orders to: Communications Electronics, Box 1002, Ann Arbor, Michigan 48106 U.S.A. If you have a Master Card or Visa card, you may call and place a credit card order. Order toll-free in the U.S. Dial 800-521-4414. If you are outside the U.S. or in Michigan, dial 313-994-4444. Order your Wabash diskettes from Communications Electronics today.

Copyright © 1982 Communications Electronics™

Ad #110582



Order Toll-Free! **wabash**
800-521-4414 **error-free**
In Michigan 313-994-4444 **diskettes**

COMMUNICATIONS
ELECTRONICS™

Computer Products Division

854 Phoenix □ Box 1002 □ Ann Arbor, Michigan 48106 U.S.A.
Call TOLL-FREE (800) 521-4414 or outside U.S.A. (313) 994-4444

CIRCLE 7 ON FREE INFORMATION CARD

SPECIAL FEATURE

- 49 **POCKET-SIZED AND PORTABLE SHORTWAVE RECEIVERS**
A look at the newest "small" shortwave receivers. Their features often rival those of older top-of-the-line table models.
Danny Goodman

BUILD THIS

- 53 **DIGITAL IC TESTER**
Part 3. A versatile device that puts IC's through their paces and indicates how they function. **Gary McClellan**
- 59 **TWO COMPACT DVM'S**
Two inexpensive DVM circuits for your workbench.
Clement S. Pepper

TECHNOLOGY

- 4 **VIDEO ELECTRONICS**
Tomorrow's news and technology in this quickly changing industry. **David Lachenbruch**
- 12 **SATELLITE/TELETEXT NEWS**
The latest happenings in communications technology.
Gary H. Arlen
- 14 **VIDEOGAMES**
A new stand-alone system and two game-cartridge reviews.
Danny Goodman
- 43 **INSIDE A 757/767 COCKPIT**
Part 2. A look at the Boeing 757/767's computer and automated-flight systems. **Marc Stern**
- 90 **STATE OF SOLID STATE**
A new IC for use in a professional-quality compressor, expander, or compander. **Robert F. Scott**

CIRCUITS AND COMPONENTS

- 65 **ALL ABOUT VLF ACTIVE ANTENNAS**
Part 2. Some practical VLF active antennas for wideband and narrowband operation. **R.W. Burhans**
- 73 **HOW TO DESIGN ANALOG CIRCUITS**
Audio power-amplifier circuits. **Mannie Horowitz**
- 78 **NEW IDEAS**
Control your household appliances using a clock radio.
- 80 **HOBBY CORNER**
Our readers solve the light-switch puzzle.
Earl "Doc" Savage, K4SDS
- 82 **THE DRAWING BOARD**
Adding a digit select to the BCD encoder. **Robert Grossblatt**

VIDEO

- 86 **SERVICE CLINIC**
Thermal problems and how to correct them. **Jack Darr**
- 88 **SERVICE QUESTIONS**
R-E's service editor solves technicians' problems.

RADIO

- 56 **HOW TO REPAIR ANTIQUE RADIOS**
The ins and outs of restoring an old radio's appearance and performance. **Richard D. Fitch**
- 98 **COMMUNICATIONS CORNER**
Communications and the computer. **Herb Friedman**

COMPUTERS

- 94 **COMPUTER CORNER**
Choosing a printer. **Les Spindle**

EQUIPMENT REPORTS

- 28 **Voicetech Industries Speech-Synthesizer Kit**
- 32 **Anders Model CM-100 Capacitance Instrument**
- 38 **Trio-Kenwood R1000 Communications Receiver**

DEPARTMENTS

- | | |
|----------------------------------|-------------------|
| 134 Advertising Index | 105 Market Center |
| 10 Advertising and Sales Offices | 103 New Books |
| 10 Editorial | 40 New Products |
| 135 Free Information Card | 6 What's News |
| 24 Letters | |

ON THE COVER

Portable shortwave-receivers with features like microprocessor-controlled PLL tuning and digital readouts, and pocket-sized shortwave receivers with "big" radio performance, were once just dreams. Both types are now realities, as you'll see in our story on pocket-sized and portable shortwave receivers. The article begins on page 49.

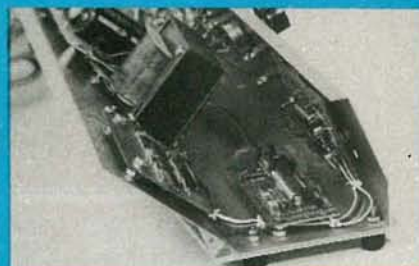

IF YOU'RE LOOKING for a DVM for your workbench, one of those described here may be for you. Thanks to the use of LSI IC's, the circuits are small and inexpensive to build. The story begins on page 59.



EVEN THOUGH MODERN RADIOS are sleek, and are great performers, there's something about the old ones that makes most of us feel nostalgic. Find out how you can restore an old radio's original sound and appearance starting on page 56.

Radio-Electronics, (ISSN 0033-7862) Published monthly by Gernsback Publications, Inc., 200 Park Avenue South, New York, NY 10003. Second-Class Postage Paid at New York, N.Y. and additional mailing offices. One-year subscription rate: U.S.A. and U.S. possessions, \$14.97. Canada, \$17.97. Other countries, \$22.47 (cash orders only, payable in U.S.A. currency.) Single copies \$1.50. © 1983 by Gernsback Publications, Inc. All rights reserved. Printed in U.S.A.

Subscription Service: Mail all subscription orders, changes, correspondence and Postmaster Notices of undelivered copies (Form 3579) to Radio-Electronics Subscription Service, Box 2520, Boulder, CO 80322.

A stamped self-addressed envelope must accompany all submitted manuscripts and/or artwork or photographs if their return is desired should they be rejected. We disclaim any responsibility for the loss or damage of manuscripts and/or artwork or photographs while in our possession or otherwise.

VIDEO ELECTRONICS

DAVID LACHENBRUCH
CONTRIBUTING EDITOR

HIGH RESOLUTION

How do you get 1,000-line resolution out of the 525-line television system? Digitally. Based on word leaking from the labs, the TV set industry here, in Europe, and in Japan is working toward doubling the number of lines a television receiver will convey by means of digital "interpolation"—generating new lines based on the average of the lines above and below them—and eliminating interlace, which wouldn't be necessary in a 60-frame-per-second picture. ITT Semiconductors in Germany has developed an all-digital signal-processing system (see **Radio-Electronics**, September 1982) which could accomplish that purpose, according to its engineers. RCA's principal goal in digital-TV circuitry is the development of a compatible high-resolution system, said William Hittinger, executive VP for research and development, who adds: "We believe it will come in this decade."

In Japan, Hitachi has developed a digital converter to separate the received luminance and chrominance signals, and double the number of scanning lines without a change in transmitter standards; it says that development of a VLSI chip could bring the cost down to the consumer level. Sony also has a digital-scanning system, non-interlaced, which doubles the number of lines by using a 60-frame-per-second picture.

CABLE COMPUTER

Later this year, your friendly neighborhood cable system may put a personal computer in your home for a few dollars a month, under a plan developed by Time Inc. and Matsushita Electric. Under the arrangement, Matsushita will develop and manufacture a combination teletext decoder and personal computer, to be distributed by cable systems carrying Time Video Information Services teletext transmissions. The decoder-computer would cost cable operators about \$150-\$200 and they'd rent it to subscribers as part of the \$5-\$10 monthly fee for teletext service. The same hardware, which probably will have 64K capacity, may also be available for sale through dealers.

BILINGUAL TV

While most video addicts look forward to multichannel TV sound to bring stereo audio to TV, the networks and some independent broadcasters see other—and perhaps more lucrative—possibilities in the standards now being worked out by an industry committee (see **Radio-Electronics**, January 1983 issue). They have their eye on "SAP"—which stands for "separate audio program," which will be a part of the new sound system, separate from the multiplexed stereo audio system. That separate channel, with a frequency response going out to 8 or 12 kHz (depending on which system is ultimately adopted) probably will get its first use in providing simultaneous dubbed Spanish sound on network shows in areas with large Spanish-speaking populations. Other suggested uses are descriptions of program action for the blind.

SOUPED-UP PROJECTION

A high-output long-life light bulb may be the key to the future of home projection-TV. General Electric's Lamp Division is working to develop a light source that will free giant-screen home television from the cathode-ray tube. A high-priority effort at GE is the development of a super-bright high-resolution projection system for the home using the principles of its industrial Talaria system, which now sells for \$40,000 and up. Unlike most TV projectors, which depend on three cathode-ray tubes to develop light, Talaria uses electron guns to distort the surface of a viscous oil layer. An external light source (xenon lamps are used in the present models) is diffracted by that modulated layer of oil through a lens system and onto the screen. GE officials are hoping to come up with the super-bright home version of Talaria in perhaps two or three years, possibly at a price between \$2000 and \$3000.

TEENY TV'S

Hot on the heels of Sony's flat-tube Watchman with the 2-inch picture will come a host of other pocket-sized monochrome TV sets. Sinclair's 3-inch flat-tube set is scheduled for sale this year, as are several sets using LCD's instead of picture tubes. Seiko's wrist TV (which has some of its electronics plus battery pack in a pocket box attached to the TV by cable), is now on sale in Japan at about \$400. Casio will soon offer a 12-ounce LCD pocket TV at about \$200. And by year's end, Sanyo expects to have LCD sets in 3- and 4-inch screen sizes. **R-E**



New from Zenith!

Two-way protection from high voltage surges for the appliances and electronics you sell or service!

A brief, high voltage surge – or spike – can occur in any electrical system and, at amplitudes lower than 600V, cause little or no damage.

But at greater amplitudes, a spike can do real damage. And the greater the high voltage surge – resulting from nearby lightning, for example – the greater the risk of harm, especially to solid-state devices.

That's why Zenith now introduces the Spike Suppressor: to protect the susceptible TV receivers and household appliances you sell or service from damaging high voltage surges!

And the Zenith Spike Suppres-

sor protects not one, but two ways.

First, the new Zenith Spike Suppressor absorbs most line voltage spikes so only a safe voltage level reaches the protected equipment.

Second, heavy or prolonged voltage surges cause the Zenith Spike Suppressor to cut off power completely for added protection and to signal the need for a replacement.

That's double-duty protection against spikes and reason enough for you to stock and sell the Zenith Spike Suppressor. Your bottom line's another. So call your Zenith distributor now!

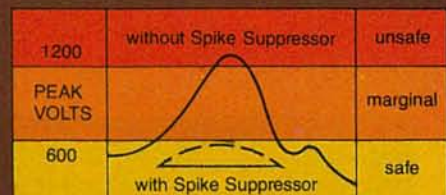

In this graph, the solid curve represents the excess voltage or "spike" imposed on an electric system and, represented by the dotted line, the protection provided household appliances as the Zenith Spike Suppressor absorbs the excess voltage and prevents it from surging thru the system.

ZENITH

The quality goes in before the name goes on.®

WHAT'S NEWS

Two RCA satellites for direct broadcast

RCA Astro-Electronics has been awarded a contract in excess of \$100 million to design and build two direct-broadcast satellites (DBS) for Satellite Television Corporation (STC), a wholly-owned subsidiary of COMSAT (Communications Satellite Corporation).

STC's initial DBS service will use two satellites to serve an area approximating the Eastern time zone of the United States. STC will offer three channels of pay television beamed directly from the satellites—which will be several times more powerful than conventional commercial satellites—to individual homes equipped with 2- to 2½-foot receiving antennas.

New satellite antenna cuts installation time

An installation-time saving of up to 70 percent is offered by the new KLM 11-foot satellite receiving antenna. That includes installation of the new heavy-duty KLM Polar-Trak mount. The average setup time of the new antenna is 2½ hours, as against the 6 to 8 hours normally required for older antennas. The new antenna is made up of radial rib sections and individual slide-in mesh panels, thus not only reducing setup time but making it shippable in compact cartons via UPS.

The KLM X-11 delivers 40.5 dB gain at 55 percent efficiency. It has

a focal length of 69 inches and a focal-length/diameter ratio of 0.47. Weight is 125 pounds and the wind resistance is up to 100 miles per hour.

Advertising aims to educate readers

"A far greater amount of information that explains the expanding array of new electronic products," is the key to attracting the public to more high-class TV receivers and other video products, says Joseph Donahue of the RCA Consumer Products Division.

To that end, RCA is publishing a special magazine, *Living With Video*, as part of its current advertising campaign. It will "help bring the average TV viewer into the expanding video age where TV sets are also sophisticated monitors for use with other video accessories such as games, videodisc players, videocassette recorders, and home computers," says Donahue. *Living With Video* devotes special chapters to the major product categories with a combination of understandable technical information and a series of "Decorating with Video" articles.

Dialog adds nine new retrieval databases

Dialog Information Services, which claims the world's largest on-line information-retrieval system, has added nine databases to the 150 already in place:

TELEGEN contains information about biology and genetic engineering in over 54,000 records.

BOOKS IN PRINT contains 650,000 records, listing the entire current U.S. book-publishing inventory.

LABORLAW has over 150,000 summaries of decisions on labor relations, fair employment, wages and hours, and occupational safety and health.

PAPERCHEM contains about 160,000 records, produced by the Institute of Paper Chemistry.

ELECTRONIC YELLOW PAGES—CONSTRUCTION DIRECTORY has more than 880,000 records covering all contractors and construction agencies.

WATERNET, the file of the American Waterworks Association, contains 5,000 records from 1971 to date.

BLS EMPLOYMENT, HOURS AND EARNINGS, with 23,000 records, provides numerical data from the U.S. Bureau of Labor Statistics.

CHEMSIS 82+, CA SEARCH, AND CHEMZERO are three databases that list almost 5 million chemical substances.

The price for searching the new databases ranges from \$30 to \$130 per connect hour—a full record printed off-line costs from 15 to 75 cents, with the majority available for 20 cents.

Literature is available from Dialog Information Services, 3460 Hillview Ave., Palo Alto, CA 94304.

Computer now responds to anybody's voice

Software that enables a computer to respond to anyone's voice was exhibited in the Mini-Micro section of the recent WESCON convention in Anaheim, CA, by Votan, a leading supplier of computer speech-technology products. The system requires no user training. It recognizes the digits 0 through 9 and eight command words, including "yes" and "no."

Speaker-independent recognition provides a set of statistically sampled utterances of a particular word by a large and varied population base, thus eliminating any need for system training by the operator. Several thousand utter-

ances are collected and analyzed to form a specific word from the population sample. Thus the computer will respond to almost anyone's pronunciation of the digit or command.

Speaker-independent word recognition eliminates time-consuming user training, and allows the untrained public to access data bases or to control equipment, even over telephone lines. Applications such as shopping by phone, voice mail, and banking all become possible simply by picking up the telephone and talking.

Votan believes that the new word-recognition product will be available in original equipment-manufacturers' quantities for less than \$2,000.

Sony starts division to develop business

To match its rapidly unfolding technological developments with potential markets, Sony has announced the establishment of a Business Development Division. According to Sony's president, Kenji Tamiya, the new division "will provide Sony with a complete structure for effectively converting our research and development investments into new business opportunities for the company."

Based at Sony's Operations Headquarters in Park Ridge, NJ, the division will work closely with Sony's research laboratories in Japan and the United States, as well as with selected outside companies. It will concentrate on CATV systems and terminals, receivers for direct satellite broadcasts, subscription TV, videotex, and teletext systems and terminals in the immediate future.

H.S. grads unqualified for engineering studies

Seventy-five percent of today's high school graduates—no matter how good their grades—just lack the necessary math and science they need to enroll in college engineering courses, reports the Electronic Industries Association (EIA). The Human Resources Council of the EIA blames the situation on "a declining national commitment" to interest high

continued on page 8

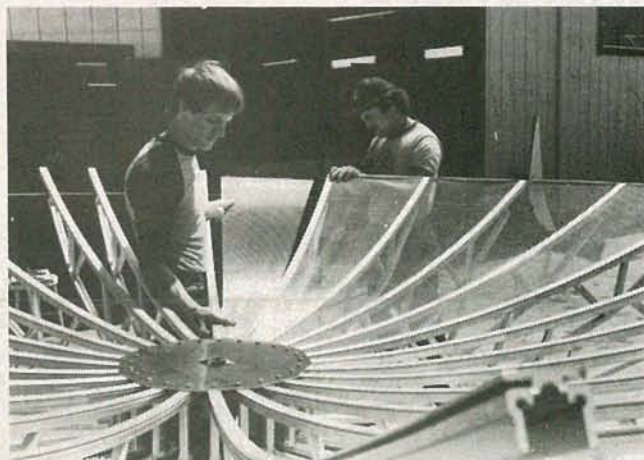

SLOTTED RIBS AND SLIP-IN MESH SECTIONS cut the KLM X-11 installation time by 60 to 70 percent.

Tek's most successful scope series ever: At \$1200-\$1450, it's easy to see why!

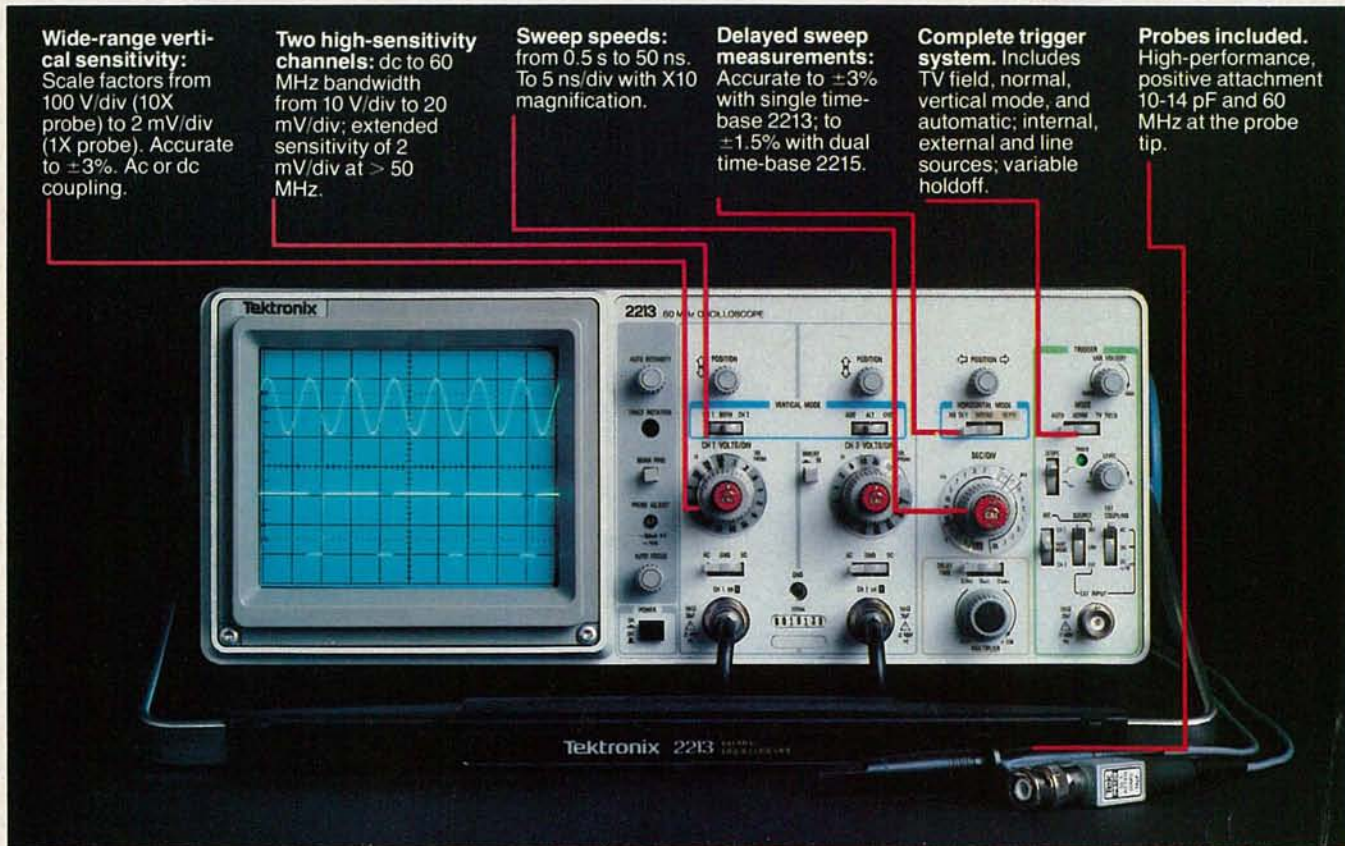

Wide-range vertical sensitivity: Scale factors from 100 V/div (10X probe) to 2 mV/div (1X probe). Accurate to $\pm 3\%$. Ac or dc coupling.

Two high-sensitivity channels: dc to 60 MHz bandwidth from 10 V/div to 20 mV/div; extended sensitivity of 2 mV/div at > 50 MHz.

Sweep speeds: from 0.5 s to 50 ns. To 5 ns/div with X10 magnification.

Delayed sweep measurements: Accurate to $\pm 3\%$ with single time-base 2213; to $\pm 1.5\%$ with dual time-base 2215.

Complete trigger system. Includes TV field, normal, vertical mode, and automatic; internal, external and line sources; variable holdoff.

Probes included. High-performance, positive attachment 10-14 pF and 60 MHz at the probe tip.

In 30 years of Tektronix oscilloscope leadership, no other scopes have recorded the immediate popular appeal of the Tek 2200 Series. The Tek 2213 and 2215 are unapproachable for the performance and reliability they offer at a surprisingly affordable price.

There's no compromise with Tektronix quality: The low cost is the result of a new design concept that cut mechanical parts by 65%. Cut cabling by 90%. Virtually eliminated board electrical connectors. And eliminated the need for a cooling fan.

Yet performance is written all over the front panels. There's the bandwidth for digital and analog circuits. The sensitivity for low signal measurements. The sweep speeds for fast logic families. And delayed sweep for fast, accurate timing measurements.

The cost: \$1200* for the 2213. \$1450* for the dual time base 2215. You can order, or obtain more information, through the Tektronix National Marketing Center, where technical personnel can answer your questions and expedite delivery. Your direct order includes

probes, operating manuals, 15-day return policy and full Tektronix warranty.

For quantity purchases, please contact your local Tektronix sales representative.

**Order toll free:
1-800-426-2200
Extension 47**

In Oregon call collect:
(503) 627-9000 Ext. 47

*Price F.O.B. Beaverton, OR. Price subject to change.

WHAT'S NEWS

continued from page 6

school students in math and science courses.

The report—available from EIA—gives information on technical education in the United States and its importance to high technology; the balance of supply and demand in various technical fields, and job opportunities in electronics.

The EIA hopes to reach local school systems—who are most important in making decisions about early science and math education—with the report, and is organizing a campaign to do so. "The problem is to be addressed," says EIA president Peter McCloskey, "at the local level with volunteer employees—at all levels—from our member companies."

Copies of the report may be obtained by contacting the EIA Human Resources Council, 2001 Eye St., N.W., Washington, DC 20006 (phone 202-457-4925).

Self-converging tubes for projection TV

The problem of converging the three images of a color projection TV, formerly attempted with complex electronic circuitry and adjustable consumer controls is now solved, reports Zenith.

The patented solution is in the tubes themselves. In a conventional projection color-TV set, three tubes—red, green, and blue—are mounted side-by-side. Only the middle (green) tube can be aimed squarely at the screen. The others are tilted slightly inward. That distorts their images on the screen, and the picture has to be converged manually.

Zenith's solution was to tilt the faceplates on the red and blue tubes slightly. That distorts the image projected on the screen. The distortion produced by the tilted face plate is in the opposite direction to the distortion caused by the off-center mounting of the outside tubes. The two distortions thus cancel each other, resulting in a perfectly "self-converged" picture. Since the correction is built into the tubes themselves, controls and electronic parts are eliminated, and correct convergence becomes automatic.

Another improvement in the new

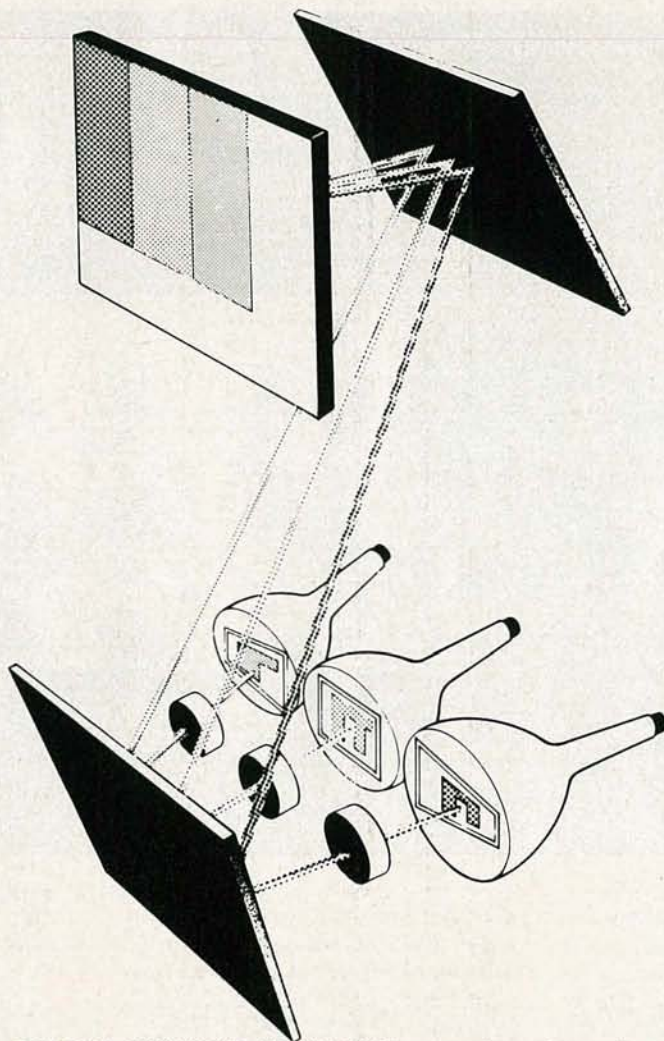

THE SELF-CONVERGING PICTURE-TUBE system. Image beams from each of the three tubes follow carefully engineered paths through precision acrylic lenses, which weigh about half as much as glass lenses. The images are then reflected by two glass mirrors that reflect more than 94 percent of the light that strikes them.

tubes is a special bipotential gun designed to maintain resolution at high brightness levels. In many conventional tubes, the dots of color on the screen tend to "bloom" whenever the tube is driven to provide a bright picture, producing a fuzzy image. Brightness must be reduced before the dots return to normal size.

The new electron gun operates on a fixed DC voltage, and is designed to hold the dots as sharp colored points at high brightness. The result is sharper detail at all levels of brightness.

Bible now published on videodisc

Noting the strong consumer response to such videodisc programs as "The Ten Commandments," RCA has licensed five volumes of *The New Media Bible*, a video translation of the Bible by the Genesis Project. RCA also has options on the additional 27 volumes for use in its videodisc system.

Seth Willenson of RCA Videodisc notes that "The Ten Commandments" has sold about 30,000 copies, which amounts to

more than \$1 million at retail prices. "We are bringing spiritual values into the home in an historical, realistic, and entertaining way that appeals to all the family," Mr. Willenson said. "To those parents who are concerned about what their children watch on television, the videodisc permits them to select from a wide variety of family-oriented programs."

Alaskan satellite in orbit

Satcom V, is a 2,385-pound advanced domestic communications satellite that was launched last October. It will provide long-distance communications within the State of Alaska, and between Alaska and the rest of the United States. The craft will also carry the state's rural area, television, and emergency medical networks.

RCA American Communications will operate the spacecraft as joint licensee with the owner, Alascom, Inc., the long-lines carrier for the state of Alaska.

RCA Satcom V is the first all-solid-state communications satellite, and is the first of a series of advanced spacecraft. They will provide up to a 50 percent increase in voice/data capacity over their predecessors, while remaining compatible with present in-orbit Satcom satellites, and with terrestrial facilities.

New CBS-Columbia group to market software

A new unit, CBS Software, has been formed to develop, license, and market game, education, and home-management software for personal home computers.

Edmund R. Auer, Senior Vice President of the Columbia Group, reports that concurrently with establishment of the CBS Software unit, a license agreement has been signed with K-Byte for the exclusive worldwide marketing and distribution rights to K-Byte computer games, including those that will be developed during the next four years.

CBS Software will initially offer the K-Byte games for the Atari 400 and 800 systems, and is evaluating several other formats for the games.



NEW Tech VOM WV-547C

Drop-proof. Fuse protected.
High impact ABS plastic case.

Rugged,
accurate taut-band meter.

Sensitivity
20,000 ohms-per volt DC
9,000 ohms-per volt AC

21 color coded ranges.

Snap action,
dual detent range switch.

Temperature scale
(optional accessory)

User oriented
"right angle" test leads.

For \$35.⁵⁰ Here's your best VOM value.



It's compact, drop-proof (3 feet) and provides 21 color-coded ranges—volts, milliamps, ohms, temperature scale and decibels. True quality instrument for your portable applications. Tough, accurate, taut-band meter, fuse-protected. Sensitivity 20,000 ohms/volt DC. High-impact case, colored bright orange. Snap action, dual-detent range switch. Range limits: 1000V DC and AC, 250 mA DC, one megohm, +200°C. Battery Test provision. Meter OFF position. Temperature scale (special probe optional).

WV-547D. Same instrument in impact-resistant carrying case. Handle converts to tilt stand.

\$39.95

Want full technical details and a demonstration? Call toll-free, 1-800-523-3696, for the VIZ distributor near you.

VIZ

**Look to VIZ for value, quality, availability.
Over 70 instruments in the line—PLUS full accessories.**

VIZ Mfg. Co., 335 E. Price St., Philadelphia, PA 19144

CIRCLE 73 ON FREE INFORMATION CARD

EDITORIAL

Electronics In Medicine

Electronics has a great impact on our day-to-day lives. It places a tremendous amount of information at our fingertips, reduces our day-to-day chores, improves the "quality" of life, and provides a virtually unlimited supply of entertainment right in our living rooms.

In fact, it we stopped to think about it for a moment, we could name many benefits that electronics makes possible. But after we finished, how many of us would have included medicine in our listings.

I'm not thinking of the electronic thermometer, either. Basic research continues to investigate new applications of electronics. For example, researchers are implanting electrodes in the inner ears of deaf people to help them hear. So far, success has been modest—patients hear medium-to-loud sounds only—but progress is continuing. When that technique is perfected, researchers envision a "bionic" ear. Along the same lines, researchers are investigating a technique for attaching an electronic camera directly to the brain; they will be using surgically implanted electrodes.

Researchers are also investigating the effects of electric fields on bone growth. Placing a fracture into an electric field has speeded the healing of bone injuries that have proven to be difficult to mend on their own.

Out of the University of Pennsylvania comes a pair of electric braces that researchers believe will cut in half the time required to straighten teeth.

On a completely different front, a researcher from the University of Florida has developed a device that shatters kidney stones. The patient lies in a bathtub and is subjected to shock waves created by high-voltage discharges. The shock waves are what break up the kidney stones.

And those are just some highlights of the intensive investigation of electronics applications in medicine. The bionic human is no longer just a fictional fantasy and may be children's reading compared to what is still to come. The promise of electronics and its limitations are still somewhere far in the distance and it's going to be a true-life experience as we live through the next few years.



ART KLEIMAN
Editor

Radio- Electronics

Hugo Gernsback (1884-1967) founder
M. Harvey Gernsback, editor-in-chief
Larry Steckler, CET, publisher
Arthur Kleiman, editor
Josef Bernard, K2HUF, technical editor
Carl Laron, WB2SLR, associate editor
Brian C. Fenton, assistant editor
Jack Darr, CET, service editor
Robert F. Scott, semiconductor editor
Herb Friedman, communications editor
Gary H. Arlen, contributing editor
David Lachenbruch, contributing editor
Earl "Doc" Savage, K4SDS, hobby editor
Danny Goodman, contributing editor
Dan Rosenbloom, production manager
Robert A. W. Lowndes, production associate
Stefanie A. Mas, production assistant
Joan Roman, circulation director
Arline R. Fishman, advertising coordinator

Cover photo by Robert Lewis

Radio-Electronics is indexed in *Applied Science & Technology Index* and *Readers Guide to Periodical Literature*.

Gernsback Publications, Inc.
200 Park Ave. S., New York, NY 10003
President: M. Harvey Gernsback
Vice President: Larry Steckler

ADVERTISING SALES 212-777-6400

Larry Steckler
Publisher

EAST

Stanley Levitan
Radio-Electronics
200 Park Ave. South
New York, NY 10003
212-777-6400

MIDWEST/Texas/Arkansas/Okla.

Ralph Bergen
The Ralph Bergen Co., Inc.
540 Frontage Road—Suite 325
Northfield, Illinois 60093
312-446-1444

PACIFIC COAST Mountain States

Marvin Green
Radio-Electronics
413 So. La Brea Ave.
Los Angeles, Ca 90036
213-938-0166-7

SOUTHEAST

Paul McGinnis
Paul McGinnis Company
60 East 42nd Street
New York, N.Y. 10017
212-490-1021



VIC20™ PERSONAL COMPUTER

(List Price \$299)

SALE!

\$139⁰⁰

(when you buy 6 tape programs at sale prices)



- We Love Our Customers Our Prices and Service Prove It!
- One Day Delivery Express Mail

We Have Commodore 64 Computers In Stock

- Commodore 64 Programmers Reference Guides Free With Purchase
- Over 500 Programs To Choose From
- Free Catalogs

You get the COMMODORE VIC-20 Computer for only \$139.00 when you buy 6 tape programs on sale for only \$59.00. These 6 tape programs list for \$96.00 to \$132.00! You can choose one of these three tape program packs: 6 GAME program pack \$59.00 (Allen Invasion, Target Command, Artillery, Chase, Snake Out, Cattle Round Up). 6 HOME FINANCE program pack \$59.00 (Check Book, Calculator, The Budgeter, Home Inventory, Income Tax, Utility Bill Saver). 6 SMALL BUSINESS program pack \$59.00 (Accountant, Accounts Receivable and Payable, Inventory, Order Tracker, Estimating and Bidding, Appointments).

33K COMMODORE VIC \$199 WITH 2½ TIMES MORE POWER

For only \$199.00 you get the COMMODORE VIC-20 Computer plus WE ADD 8,000 BYTES OF USER MEMORY to give you 2½ TIMES MORE PROGRAMMING POWER! This powerful full-sized extra featured computer includes the 6502 microprocessor (LIKE APPLE) 20,000 bytes ROM with a 16K extended LEVEL II Microsoft BASIC, 13,000 bytes RAM, a total of 33,000 bytes memory, plug in expandable to 60,000 bytes, 66 key typewriter professional expanded keyboard with graphic symbols on keys, color command keys, high resolution graphics, 512 displayable characters, text display is 22 lines 23 characters, sound and music, real time, upper lower case, full screen editing cursor, floating point decimal and trig functions, string arrays, scrolling, multi statement lines, file management, PEEK AND POKE. Assembly machine language is available. We have easy to use self teaching books and programs. Accepts TAPE-DISK AND PLUG IN CARTRIDGES, connects to any TV, includes AD adaptor, R.F. modulator, switch box, self teaching instruction book, comes in a beautiful console case.

41K COMMODORE VIC \$249 WITH FOUR TIMES MORE POWER

For only \$249.00 you get the 41K COMMODORE VIC with 400% MORE PROGRAMMING POWER THAN VIC-20! We add 16,000 bytes user memory to the VIC-20. You get a total of 41,000 bytes memory (20,000 bytes ROM, 21,000 bytes RAM and extended LEVEL II BASIC) plus all the extra features listed!

49K COMMODORE VIC \$299 WITH SIX TIMES MORE POWER

For only \$299.00 you get the SUPER POWERED 49K COMMODORE VIC with 600% MORE PROGRAMMING POWER than VIC-20! We add 24,000 bytes user memory to the VIC-20. You get a total of 49,000 bytes memory (20,000 bytes ROM, 29,000 bytes RAM and extended LEVEL II BASIC) plus all the extra features listed!

TRACTOR-FRICTION PRINTER \$399

This all new COM-STAR deluxe line printer, prints 8½" x 11" letter quality full size, single sheet, roll or fan fold computer paper, labels, etc. 40, 66, 80, 132 columns. Impact dot matrix, bi-directional, 80 CPS. Includes special cable that plugs direct into the VIC-20 printer port — no other costly interface is needed! List \$599.00 Sale \$399.00.

SUPER 10" COM-STAR PRINTER \$499

Has all the features of the COM-STAR printer shown above, PLUS! 10" carriage 100 CPS, Dot addressable bit image graphics, 2.3 buffer, 18 character sets, 40, 48, 66, 80, 96, 132 columns, prints true descender, super and subscript, underlining. Includes special cable to plug into the VIC-20 printer port. List \$699. Sale \$499.

60K MEMORY EXPANDER \$79

Allows memory expansion to 60K total (20K ROM and 40K RAM). Has six slots to add six cartridges — you can switch select any combination of memory or programs. Stop and start any program with reset button, you don't have to remove cartridges or turn off computer. This expander is a must to get the most out of your VIC-20 Computer!

PLAY ATARI GAMES ON VIC-20 \$79

WOW!! Plug in our new "GAME LOADER" and you can play all ATARI video game cartridges, Activision, Imagic M-Network on your VIC-20 computer. List \$99. Sale \$79.

LOW COST PLUG IN EXPANSION

Accessories plug in direct to this computer, extra RAM memory, data cassette, telephone modem \$99.00, deluxe 80 column printer \$399.00, 170K disk drive \$349.00 all plug in direct! You do not have to buy an expensive expansion interface!!

WE HAVE THE LOWEST PRICES

We sell direct to customers and you save the profit margin normally made by computer stores, department stores and distributors, we are willing to take a smaller margin to develop volume. WE LOVE OUR CUSTOMERS — OUR PRICES PROVE IT!

IMMEDIATE REPLACEMENT WARRANTY

If your computer fails because of warranty defect within 90 days from date of purchase, you simply send your computer to us via United Parcel Service prepaid. We will "immediately" send you a replacement computer at no charge via United Parcel Service prepaid. This warranty applies to all products we sell because WE LOVE OUR CUSTOMERS!!

15 DAY FREE TRIAL

DON'T MISS THIS SALE-ORDER NOW

- VIC-20 for only \$139. plus \$59. for 6 pack of programs Specify pack wanted _____
- 33K-VIC for only \$199.
- 41K-VIC for only \$249.
- 49K-VIC for only \$299.
- Tractor Friction Printer \$399.
- Super 10" Printer \$499.
- 60K Memory Expander \$79.
- Game Loader—Atari \$79.

We ship C.O.D. and honor Visa and Master Card.

Name _____

Address _____

City _____

State _____ Zip Code _____

VISA MASTER CARD C.O.D.

Credit Card No. _____

Expiration Date _____

Add \$10.00 for shipping, handling and insurance. Illinois residents please add 6% tax. Add \$20.00 for CANADA, PUERTO RICO, HAWAII orders. WE DO NOT EXPORT TO OTHER COUNTRIES.

Enclose Cashiers Check, Money Order or Personal Check. Allow 14 days for delivery, 2 to 7 days for phone orders, 1 day express mail!

Canada orders must be in U.S. dollars.

GET \$150 FREE SOFTWARE WHEN YOU BUY A COMMODORE 64 COMPUTER!!

PROTECTO ENTERPRISES (FACTORY-DIRECT)

BOX 550, BARRINGTON, ILLINOIS 60010
Phone 312/382-5244 to order

CIRCLE 92 ON FREE INFORMATION CARD

MARCH 1983

11

SATELLITE/TELETEXT NEWS

GARY ARLEN
CONTRIBUTING EDITOR

NATIONAL BUSINESS TELETEXT

Satellite Network Delivery Corp., a new information-distribution firm, plans to beam teletext-type data and video material throughout the U.S. via a hybrid satellite signal that will be retransmitted by local TV stations. SND's service, due to start in April, will include two primary features: *Business Teletext Network* will carry about 100 medium-speed data channels, and *T-Sat* will use digital technology to send commercials and other video programming to TV stations. The teletext service will use the vertical blanking-interval lines of a satellite transponder; SND plans to use the new North American Broadcast Teletext Standard (NABTS) technology; that is the hybrid format combining French Antiope and Canadian Telidon standards. SND data service won't be formatted as conventional page-by-page teletext frames; rather the data will be "sliced" into 100 channels within the VBI, with data moving at 3,000 characters per second. All transmissions will be addressed and encoded so that only designated customers will have access to the services. At presstime, SND was still negotiating for satellite space; the assumption is that it will find transponder room aboard a Westar bird.

TWO NEW SATELLITE PROJECTS

NASA is putting new emphasis on two activities that could lead to a sizeable new effort in satellite communications. The Advanced Communications Technology Satellite (ACTS) program will develop multiple-beam satellites that do their own switching, operate in the 30/20-GHz range, and have fixed scanning as well as spot beams. The ACTS birds would also have the capacity to handle system networking and would offer data speeds of up to 500 megabytes-per-second. The ACTS project had been shelved in recent U.S. budget cutbacks, but NASA is trying to bring it back to life, goaded in part by new Japanese activity to develop high-tech satellites of the same type.

The other new NASA effort comes in the dynamic business of mobile communications, hooked into satellite networks. The Mobile Satellite Experiment (MSat-X) would offer thin-route mobile communications for mobile phones and other transportable communications systems. NASA is trying to develop a two-by-four-foot horizontal patch antenna which would cost under \$500 and could downlink mobile communications from atop a truck.

NASA is encouraging the participation of private companies in both projects, part of the new effort to develop joint ventures between government and business.

TELETEXT NEWS BRIEFS

The National Captioning Institute, which prepares closed captions using line 21 of the vertical-blanking interval, and British Videotex-Teletext, the U.S. marketing agency which champions U.K.-format teletext, recently demonstrated a hybrid system which decodes line-21 captions into the teletext format. That would permit captions to be sent simultaneously via either system, and would assure that the 60,000 homes now equipped with Sears TeleCaption decoders (a number likely to grow) won't be stuck with obsolete equipment when teletext catches on.

Time Inc. has included several novel features in its full-channel satellite-cable teletext service now being tested in San Diego and Orlando. Time Teletext includes an audio soundtrack (primarily background music), stemming from Time's belief that viewers using a TV text service will feel more comfortable if there's an audio factor accompanying the screen images. The Time service also has a sizeable capacity for downloading data; the Zenith decoder used in the test has the ability to allow users to format material in order to retrieve specific information. For example, users can ask for data, such as "movies to be shown on Tuesday," and the terminal will collect and display information (titles, description, ratings) about films featured on that day.

WGBH-TV, Boston Channel 2, has begun its "Scoop" teletext experiment, using Antiope technology. The 100-page teletext magazine includes considerable educational and local information and is available at special receivers in public sites, such as libraries and schools.

More cable TV teletext services are springing up, among them a sophisticated package delivered by Cablevision Systems in Long Island, NY, developed in cooperation with *Newsday* newspaper. The system uses Telidon graphics and is the precursor of an advanced interactive videotex service which the cable and newspaper companies want to introduce in the near future. The *Newsday Channel*, due to begin service in April, will include news, weather, advertising, and a daily video newscast.

R-E



The ELECTRONICS BOOK CLUB

Exciting projects, troubleshooting and repair tips, and hands-on, do-it-yourself info . . . plus hundreds of time- and money-saving ideas!

18 years experience

Select 5 fact-filled volumes for only \$2.95 (total value up to \$94.75)



1486
List \$17.95



1475
List \$14.95



1245
List \$15.95 (paper)



1050
List \$12.95



1183
List \$14.95



1113
List \$10.95



1337
List \$9.95



1332
List \$16.95



1218
List \$16.95



1169
List \$17.95



1467
List \$16.95



1402
List \$14.95

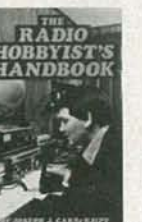

1346
List \$19.95

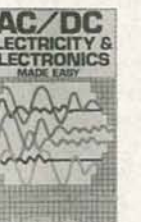

1233
List \$9.95 (paper)



1108
List \$14.95



1406
List \$17.95



1451
List \$18.95



1283
List \$12.95 (paper)



1435
List \$15.95



1160
List \$13.95



1420
List \$17.95



1296
List \$18.95



1276
List \$15.95



1436
List \$16.95

7 very good reasons to try Electronics Book Club Blue Ridge Summit, PA 17214

- **Reduced Member Prices.** Save 20% to 75% on books sure to increase your know-how
- **Satisfaction Guaranteed.** All books returnable within 10 days without obligation
- **Club News Bulletins.** All about current selections—mains, alternates, extras—plus bonus offers. Comes 13 times a year with dozens of up-to-the-minute titles you can pick from
- **"Automatic Order."** Do nothing, and the Main selection will be shipped automatically! But . . . if you want an Alternate selection—or no books at all—we'll follow the instructions you give on the reply form provided with every News Bulletin
- **Continuing Benefits.** Get a Dividend Certificate with every book purchased after fulfilling membership obligation, and qualify for discounts on many other volumes
- **Bonus Specials.** Take advantage of sales, events, and added-value promotions
- **Exceptional Quality.** All books are first-rate publisher's editions, filled with useful, up-to-the-minute information



ELECTRONICS BOOK CLUB Blue Ridge Summit, PA 17214

Please accept my membership in Electronics Book Club and send the 5 volumes circled below, billing me \$2.95 plus shipping and handling charges. If not satisfied, I may return the books within ten days without obligation and have my membership cancelled. I agree to purchase 4 or more books at reduced Club prices (plus shipping/handling) during the next 12 months, and may resign any time thereafter.

338 1050 1108 1113 1128 1160 1169
1183 1218 1225 1233 1245 1276 1283 1296
1332 1337 1346 1402 1406 1420 1435
1436 1451 1465 1467 1473 1474 1475 1486

Name _____ Phone _____

Address _____

City _____

State _____ Zip _____

(Valid for new members only. Foreign and Canada add 20%. Orders outside U.S. or Canada must be prepaid with international money orders in U.S. dollars.)
This order subject to acceptance by Electronics Book Club. RE-383

VIDEOGAMES

An exciting new home videogame-system.

DANNY GOODMAN, CONTRIBUTING EDITOR

WALK INTO ANY ONE OF LITERALLY MILLIONS of homes across the country and you're sure to see this familiar sight: the family color-TV hooked up to a videogame console, wires running all over the place, and the family engaged in a "spirited" conversation about whether Dallas or *Missile Command* will be on the screen tonight. That scene soon may be a little less common, however, thanks to the introduction of a self-contained cartridge-programmable videogame called *Vectrex* (see Fig. 1).

That is no ordinary videogame. Made by General Consumer Electronics Corporation (233 Wilshire Blvd., Santa Monica, CA 90401), it features a built-in 9-inch diagonal vector-scanning display monitor. Vector scanning produces razor-sharp outline graphics like those found on arcade games such as *Battle Zone*, *Asteroids*, and (in color) *Tempest*. Screen characters spin or glide smoothly, and the tiniest specks of light serve well as high-resolution laser blasts.

The other type of video-screen imaging, called raster scanning, allows areas to be colored in, but with less resolution. Home TV-receivers are of the raster-scan type.

Vectrex's self-contained design is unique. About the size of a small portable-TV (on its side), the unit simply plugs into any AC outlet. There's a carrying handle built into the top of the case, and one controller panel stows securely in a compartment beneath the screen. The controls on that panel include a small joystick (it's a little too small to allow for comfortable control, however) and a row of four pushbuttons. A speaker, ON/OFF/VOLUME and RESET switches, and jacks for two controller panels are located on the front of the unit, in the compartment under the screen.

Although the monitor is black and white, each game cartridge comes with a color overlay that helps jazz up the display and indicates which controller push-buttons do what. One game (*Mine Storm*) is "resident" in the unit when you buy it. Most of the 12 cartridges scheduled for introduction this year are space games, including a licensed version of *Scramble*. Other games include *Berzerk*, *Armor Attack*, a 3-D road race, and football.

Essentially a version of *Asteroids*, *Mine Storm* is challenging even for the



FIG. 1

experienced game player. In fact, most of the cartridges are tough, especially at higher levels—as they are intended to be. In fact, one early reviewer complained that the games were too tough—apparently he hasn't seen what it takes to challenge an arcade video whiz.

This is one system with a lot of potential—interesting game play, coupled with 3-D effects and a very versatile sound package. GCE is already at work on future cartridges. For the avid videogamer, *Vectrex* surely is the one to beat.

Odyssey's K.C.'s Crazy Chase for Odyssey 2

Ever since *Odyssey's* (I-40 and Straw Plains Pike, Knoxville, TN 37914) munchkin, named K.C., was held in chains by Atari's legal pursuers, he has been eager to reappear on the TV screens of *Odyssey-2* players. Now he has his chance, this time pursuing multi-segment monster, called a Dratapillar, that roams through a maze. (Is that Dratapillar perhaps a relative of Atari's dreaded

continued on page 21

RAVE REVIEWS FOR TCG!



The second edition of TCG's Master Replacement Guide is bigger and better than ever! Electronic technicians across the nation have already made it their standard semiconductor cross reference book, and it's no wonder. With more than 2,600 quality TCG parts, cross referenced to over 210,000 part numbers, this guide has more replacement line numbers than G.E. or RCA!

LOOK FOR THE FULL LINE OF QUALITY TCG REPLACEMENT PARTS:

- Transistors
- Thyristors
- Integrated Circuits
- Rectifiers and Diodes
- High Voltage Multipliers and Dividers
- Optoelectronic Devices
- Zeners
- Microprocessors and Support Chips
- Memory IC's
- Thermal Cut-Off's
- Bridge Rectifiers
- Unijunctions
- RF Transistors
- Microwave Oven Rectifiers
- Selenium Rectifiers

G.E. is a registered trademark of the General Electric Company

TCG parts perform equal to or better than any other parts on the market, and come backed by an exclusive, full two-year warranty to prove it. You're assured of

consistent quality because TCG parts are tested on state-of-the-art computerized equipment.

So be sure to ask your distributor for quality TCG replacement semiconductors in the bright green poly-bags and cartons that list device type, rating limits, diagrams and competitive equivalents right on the package!

For your own copy of the cross reference guide that technicians are raving about, see your TCG distributor, or write:



NEW-TONE ELECTRONICS
44 FARRAND STREET
BLOOMFIELD, NEW JERSEY 07003

MARCH 1983

15

Now! Learn on the latest... NRI training includes 25" Heath/Zenith color TV with state-of- the-art features

- 6-function infrared remote control
- space phone lets you answer or call from your chair
- microprocessor-controlled PLL varactor tuner
- 82 VHF/UHF, 35 cable channels
- 24-hour programmable channel selection
- electronic time display
- 4-speaker FM sound system
- choice of three cabinets at student discount

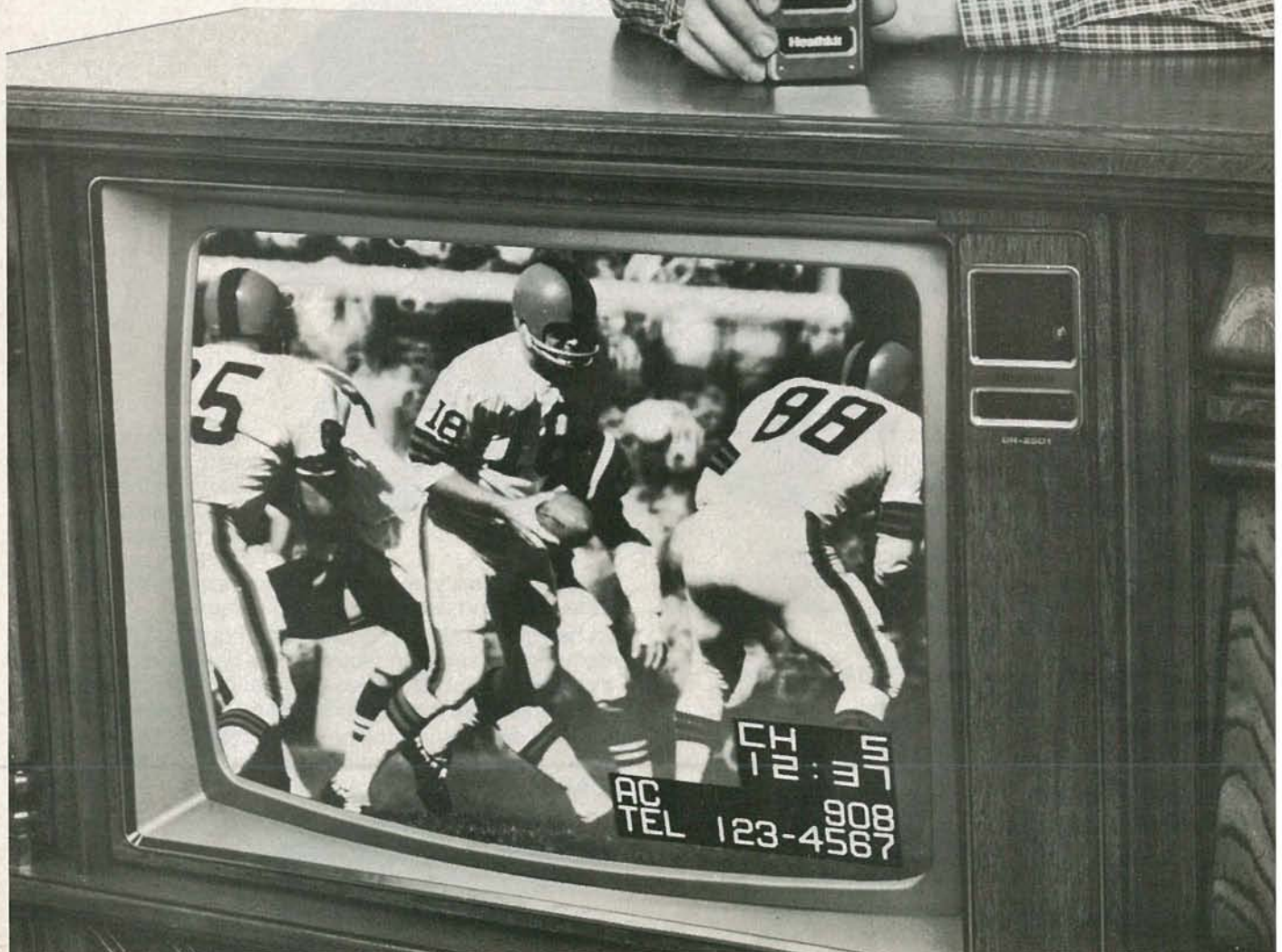

We've taken the finest, most advanced, most complete TV/Audio/Video course available and made it even better. Now NRI brings your training up to and even beyond today's technology with the exciting, advanced performance Heath/Zenith Model 2501 TV. Now you can learn how to service even the latest circuitry on the most expensive TV sets as you assemble and perform experiments on your Heathkit/Zenith. Only NRI combines such complete training with such up-to-date equipment.



Choice of specialty training on TV, stereo, or VCR

Choice of Three Specialties

And only NRI gives you the opportunity to specialize in any of three areas. You get the same complete training covering TV, audio systems, and video recorders, but you select your own specialty for practical, hands-on training.

You can choose to build the Heath/Zenith color TV; specialize in audio systems and build your own AM/FM stereo system; or take your bench training with remote-controlled videocassette recorder featuring NRI training on videotape. No matter

which specialty you elect, your practical training also includes experiments and demonstrations with the exclusive NRI Discovery Lab® and your own professional digital multimeter. All equipment is yours to use and keep.

Learn in Your Spare Time

No need to quit your job or tie up your evenings with night school...no classroom competition or rigid schedules. NRI trains you in your own home at your convenience. You're a class of one with complete course materials, practical training on the latest equipment, and the backing of a full staff of professional electronics educators. NRI brings it all to you.



Practical training on a real state-of-the-art TV using professional equipment

The Professional's Choice

A million and a half students have already chosen the NRI way. And over half the practicing TV service technicians in the U.S. have advanced their careers with convenient home training. Among them, it's NRI 3 to 1 over any other school (summary of national survey on request).

Free Catalog... No Salesman Will Call

Get all the facts on complete, convenient NRI training. See all the equipment, look over complete lesson plans, check out our convenient time payment plans. And see the many other opportunities in fields like Microcomputers, Electronic Design, Communications Electronics, and more. Send postage-paid card and see what advanced training is all about. If card has been removed, please write to us.



NRI Schools
McGraw-Hill Continuing
Education Center
3939 Wisconsin Ave.
Washington, D.C. 20016

We'll give you tomorrow.

The COEX

Anatomy of a Printer

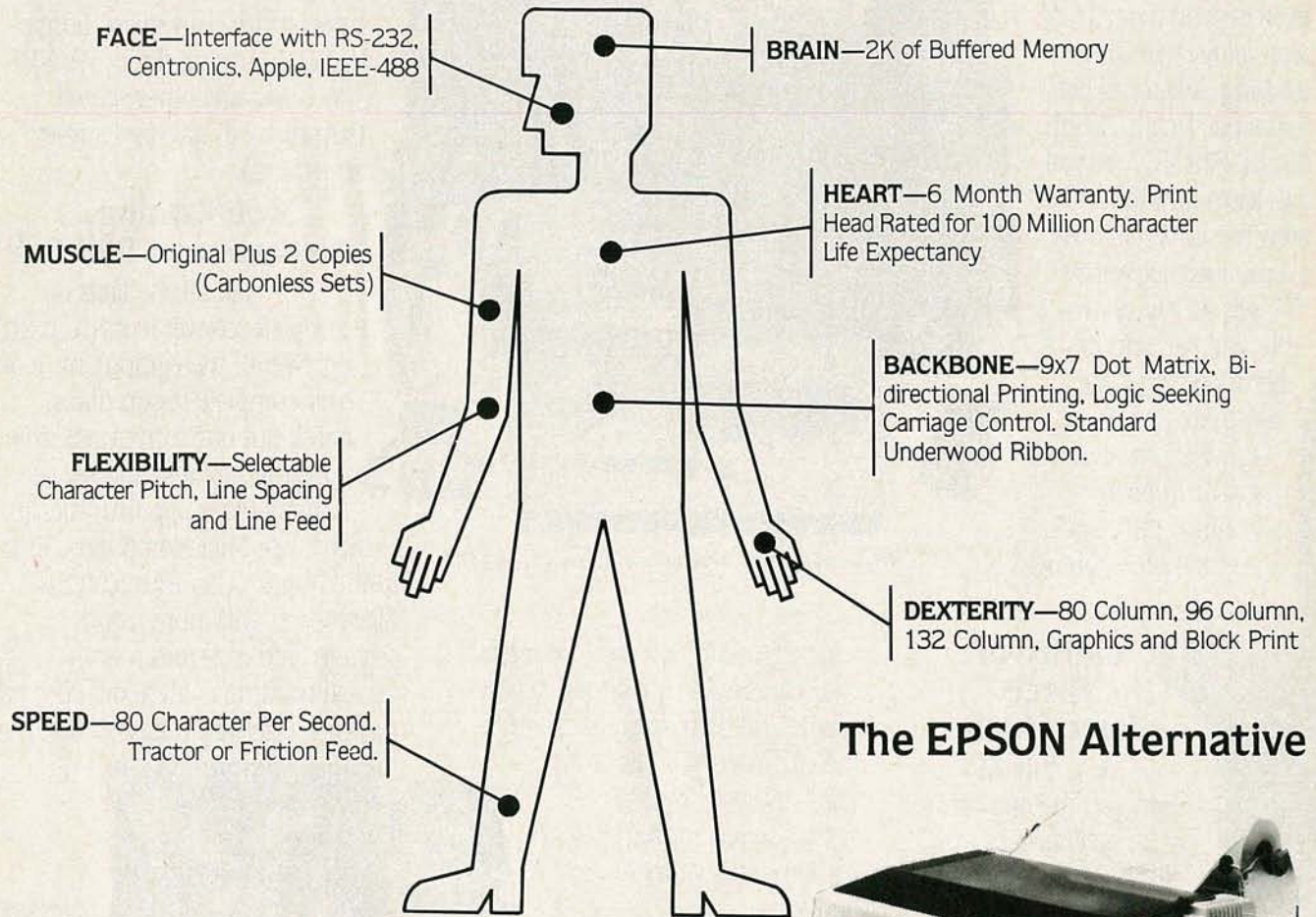

The EPSON Alternative

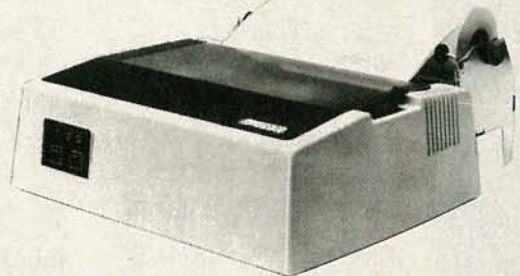

Best of all, the price . . .

\$349⁰⁰

COEX 80-FT

OPTIONS:

COEX Interface Card to Apple **\$49.95**

Demo Disc for Apple Available to Dealers

Dealer Inquiries Invited

SPECIFICATIONS:

| | |
|---------------------------------------|---|
| CHARACTER FORMATION PROCESS | Serial, impact dot matrix |
| STANDARD FONT | 9 x 7 (7 needles), 6 x 6 for graphics printing |
| PRINTING DIRECTION | Bi-directional |
| NUMBER OF COLUMNS | 80, 96 or 132. (40, 48 or 66 for enlarged characters) |
| CHARACTER SIZE | 2.57 mm (.101") x 2.0 mm (.079") for standard 80-column line |
| CHARACTER DENSITY | 5 CPI for 40 column, 10 CPI for 80 column, 12 CPI for 96 column and 16.7 CPI for 132 column |
| LINE SPACING | 1/6", 1/8" and 1/12" |
| PRINTING SPEED | 80 characters per second |
| NUMBER OF COPIES | 2 (original plus 2 copies for carbonless sets) |
| PAPER WIDTH | 8" to 10" for friction-fed paper and 3" to 10" sprocket-fed paper |
| INKED RIBBON | Standard Underwood spool type 1/2" (13 mm) wide by 11.5 yards (10.5 m) long |
| DIMENSIONS | 387 mm (15.3") wide by 309 mm (12.2") deep by 124 mm (4.9") high. With tractor-feed assy, height is 171 mm (6.7") |
| POWER CONSUMPTION | 90 watts maximum operation 25 watts standby |
| WEIGHT | 8.5 Kg (19 lbs.) |

"Have You Kissed Your Computer Lately"

Components Express, Inc.

1380 E. Edinger • Santa Ana, Calif. 92705 • 714/558-3972

Terms of Sale: Cash, Checks, Credit Cards, M.O., C.O.D. Calif. residents add 6% sales tax.

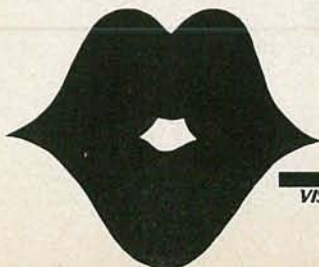

visa



VIDEOGAMES

continued from page 14



CIRCLE 101 ON FREE INFORMATION CARD

| Odyssey | K.C.'s Crazy Chase | | | | | | | | | |
|------------------|--------------------|--|--|--|--|--|--|--|--|--|
| GRAPHICS | | | | | | | | | | |
| SOUND | | | | | | | | | | |
| EASE OF LEARNING | | | | | | | | | | |
| CHALLENGE | | | | | | | | | | |
| VALUE | | | | | | | | | | |

Centipede? No one is saying.)
K.C.'s Crazy Chase is one of the first Odyssey cartridges to be compatible with Odyssey's speech-synthesis module, *The Voice*, although that accessory is not required. The game is deceptively simple at first. You control K.C.'s movements through the maze, while the six-segment Dratapillar and two smaller characters (Drats) join forces to pursue K.C. Your goal at each level is to make K.C. gobble up the Dratapillar's segments without being eaten by the Dratapillar's head or touched by a Drat. Once you eat a segment, however, the Drats turn white and flee for a few seconds. Catching up to one causes it to stop and spin while you collect bonus points. The basic strategy then, is to have K.C. chase after the Dratapillar from behind. Of course, if you can cut off a few segments from the moving Dratapillar, they stop, giving K.C. plenty of time to chew them up.

The Voice can be distracting during game play. It seems to issue warnings like, "Run" and "Hurry" at random—K.C. can be miles away from the nearest danger, and the voice will say "Look Out." That's disappointing, but it redeems itself at the end of each level (when all Dratapillar segments are

eaten) by letting out a contagious, high-pitched laugh (while K.C. hops up and down) and saying, "Incredible!" (while K.C.'s mouth moves). It will take quite a while for the novelty of the laugh to wear away.

I recently had out-of-town friends stay over a weekend. They didn't own a videogame, so their children, aged 7 and 9, were thrilled to have the luxury of having five different video-game systems and dozens of cartridges to keep them busy. The one cartridge they kept coming back to—and one that the non-gaming adults seemed to enjoy most—was *K.C.'s Crazy Chase*. That's a pretty good testimonial in my book.

Mattel's Bomb Squad for Intellivision

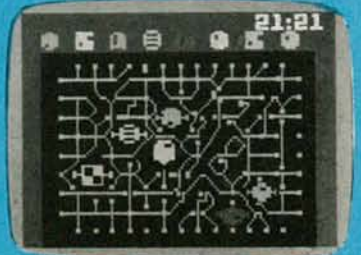

CIRCLE 102 ON FREE INFORMATION CARD

| Mattel | Bomb Squad | | | | | | | | | |
|------------------|------------|--|--|--|--|--|--|--|--|--|
| GRAPHICS | | | | | | | | | | |
| SOUND | | | | | | | | | | |
| EASE OF LEARNING | | | | | | | | | | |
| CHALLENGE | | | | | | | | | | |
| VALUE | | | | | | | | | | |

While the codebreaking games are not necessarily new, *Bomb Squad* from Mattel Electronics (5150 Rosecrans Ave., Hawthorne, CA 90250) is decidedly different and fresh. The game is designed for use with the *Intellivoice* speech-synthesis module. The speech

from the module is used to prompt you through the steps of the game. Thus, although some is merely ornamental, much of the voice output is an integral part of the game play.

The scenario of the game puts you on a bomb-disposal team whose job it is to determine the correct code numbers (only one number at the easiest level) that will defuse a bomb set to destroy a large portion of the city within thirty minutes (game time, not real time). Each code number is hidden behind a grid of 20 squares. Each square of the grid in turn represents an electronic circuit that needs fixing before you can see whether or not the square contains part of the number. You need to fix as many circuits as you can within the time period to figure out the code number from the exposed squares.

When you choose a circuit to fix, the work really begins. The screen becomes a colorful circuit board, with several components highlighted. The demolitions expert, named Frank, calls out to you (via the *Intellivoice* module) to either cut out certain components (and substitute jumper wires) or replace them with spare ones located above the circuit. In the latter instance, however, you may have to try several components to determine whether you're to follow the shape or the color of the original. In any case, you have to follow the correct sequence that Frank calls out, or you're in big trouble.

While you and Frank are busy performing circuit surgery, Boris (the terrorist who planted the bomb) razzes you with phrases like, "It won't be easy," and a European-style police-car siren rises and falls in the background.

Breaking the code is cause for celebration: an on-screen fireworks display over the city's skyline and Frank hearty proclaims that "You're a hero!" But if you guess wrong, he says "Oh, no!"—and the skyline loses one-third of its buildings in an explosion while the waterfront ripples from the blast.

Bomb Squad is not a game to pick up for an easy or quick play. You'll need to understand the manual thoroughly before you get the hang of it. And be prepared for a lengthy sit-down. If adventure and strategy are your games, you'll enjoy *Bomb Squad*, but it's not something you will play over and over in one session. **R-E**

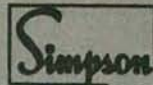

TRIPLETT

KEITHLEY

LEADER



Non-Linear Systems

BK PRECISION

15 MHz TRIGGERED SWEEP SCOPE

MODEL 1477



CALL FOR OUR GRAND OPENING PRICES

- Mode automatically shifts between CHOP and ALTERNATE
- Bright P31 blue phosphor
- Front-panel X-Y operation
- Differential input capability
- 19 calibrated sweeps—.5 μ SEC/cm to .5SEC/cm
- Sweep to .1 μ SEC/cm with 5x; 1.5SEC/cm with uncalibrated vernier

BK PRECISION

30 MHz TRIGGERED SCOPE

MODEL 1479B



CALL FOR OUR GRAND OPENING PRICES

- Built-in signal delay line permits view of leading edge of high frequency pulse rise time.
- Triggers on signals up to 50MHz
- Rectangular CRT with P31 phosphor
- Mode automatically shifts between CHOP and ALTERNATE

BK PRECISION

70 MHz. Dual Time BASE SCOPE

MODEL 1570



CALL FOR OUR GRAND OPENING PRICES

- 1 mV/division sensitivity to 70 MHz
- 500 μ V/division cascade sensitivity
- Four-input operation provides trigger view on 4 separate inputs.
- Alternate time base operation
- Switching power supply delivers best efficiency and regulation at lowest weight

BK PRECISION

100MHz Dual Time BASE SCOPE



MODEL 1590

\$1,595.00
While quantities last

- 1mV/division sensitivity to 100MHz
- 500 μ V/division cascade sensitivity
- 2ns/division sweep rate with 10 \times magnifier
- Four-input operation provides trigger views or four separate inputs
- Selectable 1M Ω or 50 Ω inputs
- Alternate timebase operation
- 20MHz bandwidth limiter for best view of low frequency signals
- Lighted function pushbuttons employing electronic switching with non-volatile RAM memory
- Switching power supply delivers best efficiency and regulation at lowest weight
- Selectable frequencies for chop operation

PRICE DOES NOT INCLUDE PROBES

KEITHLEY

DIGITAL MULTIMETERS

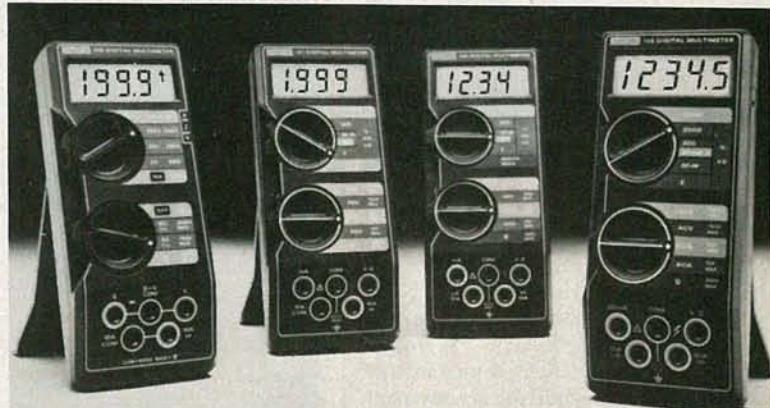

Model 128: Beeper DMM designed to meet the tough specifications of a major computer manufacturer. See/hear display includes over/under arrow and on/off beeper.

Model 131: 0.25% accuracy added to the easiest to use handheld DMM. Color-coded front panels for maximum clarity, minimum confusion.

Model 130: Keithley user research led to unique DMM designs. Easy to read LCDs, largest DMM displays on the market.

Model 135: First 4 $\frac{1}{2}$ -digit handheld DMM, ideal for analytical/bio-medical service. 10A range standard on all Keithley handhelds.

Model 128: \$139.00

Model 130: \$124.00

Model 131: \$139.00

Model 135: \$235.00

ORDERING INFORMATION

We don't just take orders we ship orders
Advance Electronics endeavors to keep everything we advertise in stock for immediate delivery.

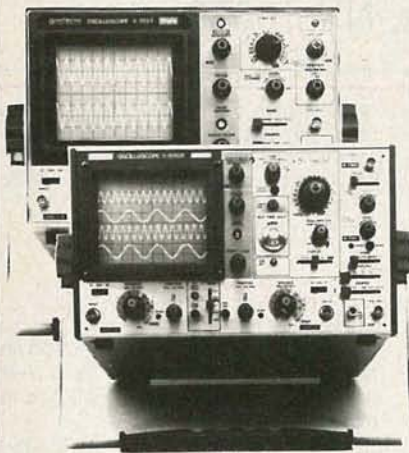

- Mastercharge & Visa shipped within 24 hours.
 - Bank checks or Money Orders shipped within 24 hours.
 - Personal checks — please allow 3 weeks for check to clear.
 - All prices plus shipping charges. Please call for appropriate charges. Use our toll free number.
 - New York State residents add appropriate sales tax.
 - PRICES SUBJECT TO CHANGE WITHOUT NOTICE.
- Quantities are limited

BK PRECISION**HITACHI****FLUKE****VIZ** FORMERLY **ROA****HICKOK****DATA PRECISION****DORIC****HITACHI OSCILLOSCOPES**

| | | | |
|-------|---------|------------|------------------------|
| V134 | 10 MHz | Dual Trace | Storage |
| V202 | 20 MHz | Dual Trace | |
| V203 | 20 MHz | Dual Trace | w/delay sweep |
| V209 | 20 MHz | Dual Trace | Portable |
| V352 | 35 MHz | Dual Trace | w/delay line |
| V353 | 35 MHz | Dual Trace | w/delay sweep |
| V509 | 50 MHz | Dual Trace | Portable w/delay sweep |
| V650 | 60 MHz | Dual Trace | w/delay sweep |
| V1050 | 100 MHz | Quad Trace | w/delay sweep |

All in Stock Ready for immediate shipment.
Call for our Special Grand Opening Prices.

All Hitachi Oscilloscopes feature 2 year parts and labor warranty.

FLUKE**4½ DIGIT MULTIMETERS**

MODEL 8060A

**\$349⁰⁰**

- Frequency measurements to 200KHz
- dB measurements
- Basic dc accuracy 0.04%; 10 μ V, 10 nA and 10 m Ω sensitivity.
- Relative measurements
- True RMS
- High-speed Beeper

BK PRECISION**INDUSTRIAL TRANSISTOR TESTER****\$189⁹⁵**
was \$239

MODEL 520B

- Now with HI/LO Drive
- Works in-circuit when others won't
- Identifies all three transistor leads
- Random lead connection
- Audibly and visually indicates GOOD transistor

BK PRECISION**POWER SUPPLIES****\$279⁰⁰**
was \$354.

MODEL 1601

- Isolated 0-50VDC, continuously variable; 0-2A in four ranges
- Fully automatic shutdown, adjustable current limit
- Perfect for solid state servicing

**\$299⁹⁵**
was \$375

MODEL 1650

- Functions as three separate supplies
- Exclusive tracking circuit
- Fixed output 5VDC, 5A
- Two 0 to 25VDC outputs at 0.5A
- Fully automatic, current-limited overload protection

- Continuity and relative reference functions identical to 8060A.
- True RMS measurements to 30 kHz.
- Basic dc accuracy 0.05%; 10 μ V, 10 nA and 10 m Ω sensitivity.
- Beeper

MODEL 8062A

**\$279⁰⁰****BK PRECISION****FUNCTION GENERATORS**

MODEL 3010

- Sine, square and triangle output
- Variable and fixed TTL outputs
- 0.1 Hz to 1MHz in six ranges
- Push button range and function selection
- Typical sine wave distortion under 0.5% from 1 Hz to 100kHz

MODEL 3010 **\$179⁹⁵**
was \$220.MODEL 3020 **\$299⁹⁵**
was \$379.**SWEEP FUNCTION MODEL 3020**

- Four instruments in one package—sweep generator, function generator, pulse generator, tone-burst generator
- Covers 0.02Hz-2MHz
- 1000:1 tuning range
- Low-distortion high-accuracy outputs

BK PRECISION**CAPACITANCE METERS**

MODEL 830

- Automatically measures capacitance from 0.1pF to 200mF
- 0.1pF resolution
- 0.2% basic accuracy
- 3½ digit LCD display

\$179⁹⁵
was \$229.**\$149⁹⁵**
was \$185.

MODEL 820

- Resolves to 0.1pF
- 4 digit easy-to-read LED display
- Fuse protected against charged capacitors
- Overrange indication

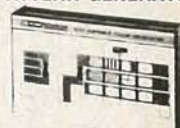
BK PRECISION**COLOR PATTERN GENERATOR**MODEL 1210 **\$129⁹⁵**
was \$159

- Generates 10 stable patterns including crosshatch, 7x11 dot, gated rainbow and purity.
- Compact for convenient field service use



TOLL FREE HOT LINE
800-223-0474

THE TEST EQUIPMENT SPECIALISTS

26 WEST 46th STREET, NEW YORK, N.Y. 10036 212-730-7030

ADVANCE ELECTRONICS

LETTERS

Address your comments to: Letters, Radio-Electronics,
200 Park Avenue South, New York, NY 10003

RADAR DETECTORS

The October 1982 issue of **Radio-Electronics** contains a letter on radar detectors by Mr. J. Frank Fields. Much of his letter is aimed at a letter of mine which had been published previously, but much of it is beside the point, because I had expressed no opinion in regard to the accuracy or reliability of radar speed measurements but had limited my discussion to the probable use to which radar detectors were put.

To support his views, Mr. Fields offers 20 years' experience as a physicist with the Department of Defense. To support mine I would offer over 50 years of driving experience. During that time, I have driven over a half million miles in 40 of the 50 States and in 10 of the 12 Provinces of Canada. Everywhere I have gone, I have observed that the vast majority of drivers exceed the speed limit when they think they can get away with it. Any impartial person can check that for himself by

taking his car on an unpatrolled section of expressway and seeing what happens when he drives at exactly the speed limit—nearly everyone else will pass him. From that, I would conclude that is the intent of most drivers to break the speed-limit laws.

At the same time, I have observed that when a police car is visible, all traffic slows down. From that I would conclude that it is the intent of most drivers to avoid getting caught for speeding. Whether they accomplish that by having one eye peeled for a police car, or by use of an electronic device is immaterial. The intent is the same.

Mr. Fields then gives some "other" uses for radar detectors, but it will be noted that in each case he starts with the assumption that the car is being driven within the speed limit. If my observation (that drivers who consistently drive within the limit even when they are unobserved by the police are insignificant portion of the total driving population) are cor-

rect, then it follows that Mr. Field's other uses for radar detectors are insignificant when compared to the primary most probable use, which is to avoid getting caught speeding.

RICHARD KOLASINSKI
Richmond, MI

COMPONENT CHECKING

I enjoyed Karl Thurber's article on buying mail-order components (**Radio-Electronics**, September and November, 1982). I would really like to make several additions to his excellent article.

When checking diode or transistor junctions with a VOM, the readings are relative to the voltage and current impressed on the device. I have found the $R \times 1$ current on various ohmmeters to be as much as 320 mA. Readers would be advised to measure their $R \times 1$ scale with a milliammeter so they don't overcurrent the device under test. A way to do

We accept VISA, MC,
C.O.D., CHECK or M.O.

FIRST QUALITY COMPONENTS - NOT MAIL ORDER "SECONDS"

Min. order \$10.00 - add
5% Shpg and \$1.00 Ins

ARIES ZERO INSERTION FORCE SOCKETS



cam actuated, true zero insertion
-tin plated solder tail pins
capable of being plugged into
dip sockets, including wire wrap

| Stock No. | No. of Pins | 1-9 | 10-49 | 50 |
|-----------|-------------|-------|--------|--------|
| 11055 | 24 | 4.98 | \$4.35 | \$3.90 |
| 11056 | 28 | 5.15 | 4.50 | 4.05 |
| 11057 | 40 | 6.81 | 5.95 | 5.35 |
| 11058 | 64 | 12.02 | 10.50 | 9.45 |

RESISTOR ASSORTMENT

82508 - 700 pcs (1 each below assortment)

\$22.50

Stock No. 82501 10 ea. of 10-12-15-18-22-27-33-39-47-56 OHM
Stock No. 83502 10 ea. of 68-82-100-120-150-180-220-270-330-390 OHM
Stock No. 82503 10 ea. of 470-560-680-820-1K-1.2K-1.5K-1.8K-2.2K-2.7 OHM
Stock No. 82504 10 ea. of 3.3K-3.9K-4.7K-5.6K-6.8K-8.2K-10K-12K-15K-18K OHM
Stock No. 82505 10 ea. of 22K-27K-33K-39K-47K-56K-68K-82K-100K-120K OHM
Stock No. 82506 10 ea. of 150K-180K-220K-270K-330K-390K-470K-560K-680K-820K OHM
Stock No. 82507 10 ea. of 1M-1.2M-1.5M-1.8M-2.2M-2.7M-3.3M-3.9M-4.7M-5.6M OHM

\$3.95 each
for any
assortment

WILD ROVER

Touch switch capsule.
Operating motion is .005" without the
use of a levered arm. Extremely fast on
and off with low noise. Normally oper-
ated 115 VAC, 1.6 amp-30 milliohm re-
sistance - .515 radius by .160 thick.



Stock No. 1-9 10 25
12098 \$ 1.28 \$ 1.12 \$.95

60/40 ROSIN CORE SOLDER

| Stock No. | Dia | Length (feet) | Weight (oz) | Price |
|-----------|------|---------------|-------------|--------|
| 50075 | .062 | 9 | 1.5 | \$1.16 |
| 50076 | .062 | 25 | 4 | 2.39 |
| 50077 | .062 | 50 | 8 | 4.25 |
| 50078 | .032 | 33 | 1.5 | 1.31 |
| 50079 | .032 | 88.5 | 4 | 2.47 |
| 50080 | .032 | 175 | 8 | 4.27 |



TI WIRE WRAP SOCKETS

Tin plated phosphor
bronze contact - 3 wrap



| Stock No. | No Pins | 1-24 | 25 100 |
|-----------|---------|--------|---------------|
| 11301 | 8 | \$.45 | \$.40 \$.36 |
| 11302 | 14 | .66 | .59 .54 |
| 11303 | 16 | .72 | .64 .58 |
| 11304 | 18 | .82 | .73 .66 |
| 11305 | 20 | 1.11 | .99 .90 |
| 11306 | 22 | 1.26 | 1.12 1.02 |
| 11307 | 24 | 1.41 | 1.25 1.14 |
| 11308 | 28 | 1.71 | 1.52 1.38 |
| 11309 | 40 | 2.31 | 2.05 1.86 |

TI LOW PROFILE SOCKETS

Tin plated phosphor
bronze con. ICI pins
with gas tight seal



| Stock No. | No Pins | 1-24 | 25 100 |
|-----------|---------|--------|---------------|
| 11201 | 8 | \$.15 | \$.13 \$.12 |
| 11202 | 14 | .18 | .15 .14 |
| 11203 | 16 | .21 | .18 .16 |
| 11204 | 18 | .24 | .21 .19 |
| 11205 | 20 | .27 | .24 .21 |
| 11206 | 22 | .30 | .26 .23 |
| 11207 | 24 | .33 | .30 .25 |
| 11208 | 28 | .38 | .34 .29 |
| 11209 | 40 | .53 | .45 .40 |

ELPAC POWER SUPPLIES - DC/DC CONVERTERS



| SINTEC Stock No. | ELPAC Part No. | Input Voltage (VDC) | Output Voltage (VDC) | Output Current (mA) | Dimensions (HxWxD) in Inches | Price |
|------------------|----------------|---------------------|----------------------|---------------------|------------------------------|---------|
| 13825 | CB3801 | 3-0-7.0 | 12-0-6 | 0-25 | 48x51x3.05 | 7.95 |
| 13826 | CB3811 | 3-0-7.0 | 12-0-6 | 0-35 | 48x51x3.05 | 7.95 |
| 13827 | CB3802 | 3-0-7.0 | 15-0-7 | 0-20 | 48x51x3.05 | 7.95 |
| 13828 | CB3812 | 3-0-7.0 | 15-0-7 | 0-20 | 48x51x3.05 | 7.95 |
| 13829 | CB3804 | 3-0-7.0 | 28-0-7 | 0-10 | 48x51x3.05 | 7.95 |
| 13830 | CB3814 | 3-0-7.0 | 28-0-7 | 0-10 | 48x51x3.05 | 7.95 |
| 13831 | CL3801 | 4-0-7.0 | 12-0-6 | 125 | 85x11x2.11 | \$24.95 |
| 13832 | CL3811 | 4-0-7.0 | 12-0-6 | 125 | 85x11x2.11 | 24.95 |
| 13833 | CL3802 | 4-0-7.0 | 15-0-7 | 100 | 85x11x2.11 | 24.95 |
| 13834 | CL3812 | 4-0-7.0 | 15-0-7 | 100 | 85x11x2.11 | 24.95 |
| 13835 | CL3804 | 4-0-7.0 | 28-1-4 | 50 | 85x11x2.11 | 24.95 |
| 13836 | CL3814 | 4-0-7.0 | 28-1-4 | 50 | 85x11x2.11 | 24.95 |

Stock No. 13801 - "Floppy Disc"
Power Supply For
Winchester Drives \$109.00
13801-1 Data Sheet for 13801 \$.25

Special of the Month!



DIGITAL MULTIMETER
Single rotary switch operation. Large, easy to read, 5 3-1/2 digit display, 800 hours operating life with single 9v battery. Seven functions—(DC Volts, DC Amps, Ohms, AC Volts, AC Amps, Diode and Resistor Junction, Audible Continuity Check).

Stock No. 62503
\$75.00

Full 1 year warranty

Stock No. 62504
Carrying case with belt loop \$7.50

MODUTEC



Miniclamp AC Volt-Ammeter
allows singling one conductor out of many without disarrangement.

Set of THREE \$99.00

| Stock No. | AC Amperes | Price |
|-----------|------------|---------|
| 13730 | 0-25A | \$39.50 |
| 13731 | 0-50A | 39.50 |
| 13732 | 0-100A | 39.50 |

ACCESSORY LINE SPLITTER
allows fast readings of AC power consumption of plug in equipment without separation of leads.

Stock No. 13727 \$9.95

POCKET SIZED BATTERY TESTER
for all types of small batteries from 1.35v to 4.5v
Stock No. 13733 \$13.95

VOLT-I-CATOR
automotive diagnostic meter plugs into lighter socket and indicates battery condition and charging rates.

Stock No. 13736 \$15.95

AC VOLTAGE TESTER
plugs into any 110v service receptacle to check line voltage over 50-150 VAC

Stock No. 13735 \$14.95

VOM-MULTITESTER
versatile Volt-Ohm-Milliammeter in small package
Stock No. 13729 \$13.95

ELPAC POWER SUPPLIES - SOLV SERIES FULLY REGULATED



| SINTEC Stock No. | ELPAC Part No. | Output Voltage | Output Current Rating | Dimensions (HxWxD) in Inches | OVP | Price |
|------------------|----------------|----------------|-----------------------|------------------------------|----------------|---------|
| 13802 | SOLV15-5 | 5 | 3.0A | 4-7/16x4-1/2 | Fixed included | \$39.95 |
| 13803 | SOLV15-12 | 12 | 1.5A | 4-7/16x4-1/2 | Fixed included | 39.95 |
| 13804 | SOLV15-15 | 15 | 1.2A | 4-7/16x4-1/2 | Fixed included | 39.95 |
| 13806 | SOLV15-24 | 24 | 0.75A | 4-7/16x4-1/2 | Fixed included | 39.95 |
| 13808 | SOLV30-5 | 5 | 6.0A | 5-5/8x7-7/8x3-1/8 | OVP-4 | 59.95 |
| 13809 | SOLV30-15 | 15 | 4.0A | 5-5/8x7-7/8x3-1/8 | OVP-4 | 59.95 |
| 13810 | SOLV30-15 | 15 | 3.2A | 5-5/8x7-7/8x3-1/8 | OVP-4 | 59.95 |
| 13812 | SOLV30-24 | 24 | 2.0A | 5-5/8x7-7/8x3-1/8 | OVP-4 | 59.95 |

13802-1 Data Sheet for SOLV Series

PIN FORMING TOOL

puts IC's on their true row to row spacing. One side is for .300 centers. Flip tool over for devices on .600 centers. Put device in tool and squeeze.

ONE TOOL DOES 8 THRU 40 PINS!
Stock No. 11059 \$12.95

OK MACHINE AND TOOL



IC INSERTION/EXTRACTION KIT
Includes DIP IC extractors and inserters to accommodate all ICs from 14 to 40 pins. Tools that engage conductive surfaces are CMOS safe and include grounding lug. Stock No. 13309 \$37.74

SOCKET WRAP ID

DIP socket-sized plastic panels with numbered holes in pin locations. Slip onto socket before wire wrapping to identify pins. Also write on them for locations, IC part number, function, etc. Simplifies initial wire wrapping, troubleshooting and repair.
\$1.82 per pack

IC EXTRACTOR

One-piece, spring steel construction. Will extract all LSI, MSI and SSL devices with 8 to 24 pins.
Stock No. 13313 \$2.10

SINTEC CO.

Drawer Q Milford
NJ 08848-9990



TOLL 800-526-5960
FREE in NJ (201) 996-4093

Send for Free Catalog -
over 1100 parts.

that is to measure the resistance of a good silicon or germanium diode with a milliammeter in series with it. Write the current reading (in the forward direction) on the VOM case for reference. Keep in mind that some ohmmeters may have reversed polarity on the test leads, and that some digital ohmmeters have such low voltage and current that a good junction will check open with either polarities.

Salvaging used components has great educational value. After testing thousands of resistors, capacitors, etc. the technician develops a good sense of how components change or fail. I use salvaged components to run "destructive" life tests. Do you know how hot a resistor gets at full load or how many volts you can put across a 400-volt capacitor before it blows? Lastly the sources of components mentioned in the article are also a good place to buy good industrial quality but old test equipment.

DELBERT S. SHAFER, CET
Warren, OH

VOLTAGE FREEZER

Leonard Lee's voltage-freezer circuit (New Ideas, *Radio-Electronics*, November 1982) is a good solution to what is sometimes a vexing problem in circuit accessibility. I do have some comments on protecting the components in the circuit to ensure a long and healthy life, however.

First, if the circuit voltage being measured has a low impedance, the tantalum capacitor could be damaged by a characteristic of solid tantalums—lack of electrolyte mobility. The current should be limited a series resistor to 333 mA. In addition, if the leads are even briefly reversed, the capacitor could be damaged. A better idea is to use a polypropylene or polycarbonate capacitor. An additional advantage to those capacitors is lower leakage, and no series resistor is required.

Second, a series resistor should be used between the capacitor and the non-inverting input of the op-amp. Since op-amps can be damaged in any number of ways (input signals outside the supply rails, excessive differential-mode voltage due to slew-rate limits, etc.) the resistor (about 10K is enough) can limit the input stage current to a safe value in case of a reversed or out-of-limit input voltage. That series resistor will not add any error because of the high op-amp input impedance.

Third, be sure that you *never* turn off the supply voltage while the storage cap is still charged. That will result in a high substrate current in the IC after which you can kiss it goodbye! Always discharge the cap before shutting off the voltage freezer.

CHAS. HANSEN
Tinton Falls, NJ

WHAT'S BETA?

I must compliment Manny Horowitz on his fine series written about analog circuits. It is an excellent review for me, and it also enlightens me about some subjects I have not studied.

There is an error however, in an equation as published (Equation 3-b in August 1982 issue). As written it is $\beta = \alpha/(\alpha-1)$. When trying to prove the formula (i.e. how is it derived?) by substituting I_C/I_B for β and I_C/I_E for α and 1 replaced with I_E/I_E , it reduced to $I_E = I_C - I_B$. This is incorrect because $I_E = I_C + I_B$. At first, I thought my algebra incorrect (I still

did not notice that the formula was wrong) and only when plugging in an assumed α ($\alpha = .99$ when $\beta = 100$) in the original equation and getting a negative β for an answer did I realize that the denominator was reversed. The correction equation is $\beta = \alpha/(1 - \alpha)$.

There is also a statement that bothers me. It appears in the next-to-last paragraph on page 54: "Because the emitter current is equal to the base current multiplied by beta..." That is only an approximation. I learned that: $I_B = I_E/(\beta + 1)$ so $I_E = I_B(\beta + 1)$ and $I_C = I_B\beta$, neglecting leakage currents. I realize that it seems nit-picky on my part; however, having survived through 3rd Semester Electronics at Idaho State University (an excellent program and faculty by the way), I am conditioned: $I_C = I_B\beta$ and not $I_C \approx I_E$, although that approximation can be used in many in-

stances. My point is that the word "approximately" should be used as a clarification and caution so that a beginner might not get misled and confused.

ANDREW HITT
Boise, ID

NOT HIS WHOLE LIFE

Hurrah for Joseph Miller's letter suggesting that you ease off computer articles. New all-band receivers, amateur transceivers, scanners, radar detectors, and hi-fi receivers are hitting the market every day. Let's hear about them. Although I own a computer, it's not my whole life—I hope it doesn't become yours.

JOHN R. MYERS, K5CUY
Kingsland, TX

R-E

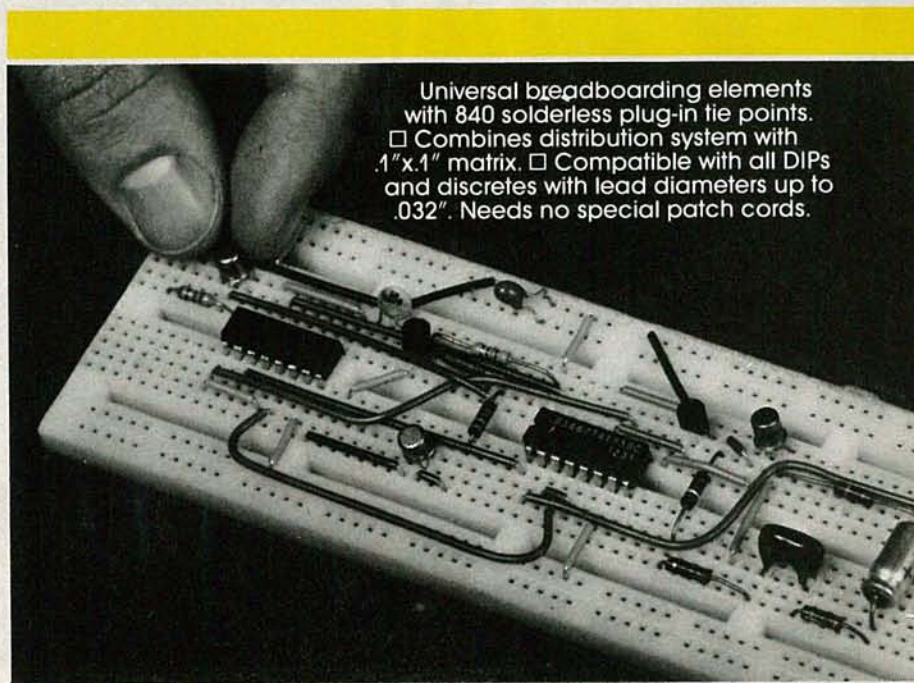

Universal breadboarding elements with 840 solderless plug-in tie points.
 Combines distribution system with 1"x.1" matrix. Compatible with all DIPs and discretes with lead diameters up to .032". Needs no special patch cords.

ERASABLE CIRCUIT BUILDING.

Build a circuit almost as fast as you dream it up. Pull it apart and do another—everything's as good as new.

Our versatile Super-Strip mini-breadboards give you the same top-quality contacts you get in our full-scale ACE All-Circuit Evaluators. Not so "mini," either. You can build circuits with

as many as nine 14-pin DIPs.

Instant-mount backing and quick-removal screws make stacking and racking a snap, too.

Where to buy? Phone (toll-free) 800-321-9668 for the name of your local A P distributor. In Ohio, call collect 216-354-2101. And ask for our complete A P catalog.



A P PRODUCTS INCORPORATED
9450 Pineneedle Drive
P.O. Box 603
Mentor, Ohio 44060
(216) 354-2101
TWX: 810-425-2250

In Europe, contact A P PRODUCTS GmbH
Baumlesweg 21 • D-7031 Weil 1 • W. Germany

"I built this 16-bit computer and saved money. Learned a lot, too."

Save now by building the Heathkit H-100 yourself. Save later because your computer investment won't become obsolete for many years to come.

Save by building it yourself. You can save hundreds of dollars over assembled prices when you choose the new H-100 16-Bit/8-Bit Computer Kit—money you can use to buy the peripherals and software of your choice.

H-100 SERIES COMPUTER SPECIFICATIONS:

USER MEMORY:
128K-768K bytes

MICROPROCESSORS:
16-bit: 8088
8-bit: 8085

DISK STORAGE:
Built-in standard
5.25" disk drive.
320K bytes/disk

KEYBOARD:
Typewriter-style,
108 keys, 13
function keys,
18-key numeric pad

GRAPHICS:
Always in graphics mode.
640h/225v resolution;
up to eight colors
are available

COMMUNICATIONS:
Two RS-232C Serial
Interface Ports and
one parallel port

DIAGNOSTICS:
Memory self-test
on power-up

AVAILABLE SOFTWARE:
Z-DOS (MS-DOS)
CP/M-85
Z-BASIC Language
Microsoft BASIC
Multiplan
SuperCalc
WordStar
MailMerge
Data Base
Manager
Most standard
8-bit CP/M
Software

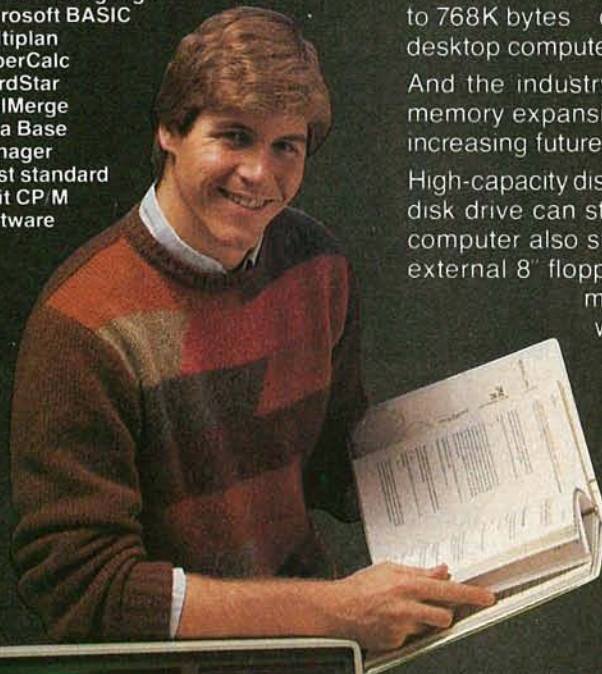

128K bytes standard Optional

The H-100 is easy to build—the step-by-step Heathkit manual shows you how. And every step of the way, you have our pledge—"We won't let you fail." Help is as close as your phone, or the nearest Heathkit Electronic Center.

And what better way to learn state-of-the-art computing techniques than to build the world's only 16-bit/8-bit computer kit? To run today's higher-speed, higher-performance 16-bit software, you need an H-100. It makes a significant difference by processing more information at faster speeds.

Dual microprocessors for power and compatibility. The H-100 handles both high-performance 16-bit software and most current Heath Zenith 8-bit software.

Want room to grow? The H-100's standard 128K byte Random Access Memory complement can be expanded to 768K bytes—compared to a 64K standard for many desktop computers.

And the industry-standard S-100 card slots support memory expansion and additional peripheral devices, increasing future upgradability of the H-100.

High-capacity disk storage, too. The H-100's 5.25" floppy disk drive can store 320K bytes on a single disk. The computer also supports an optional second 5.25" and external 8" floppy disk drives. And an optional multi-megabyte internal Winchester disk drive will be available in the near future.

The H-100 gives me the most for my computer dollar!



Critical circuits are pre-assembled, making the H-100 easier and faster to build!

Want beautiful high-resolution graphics? You can create extensive charts, drawings, graphs and symbols to meet your needs using the H-100's bit-mapped graphics and its 640 x 225 pixel video display.

The H-100 gives you total communications flexibility. Three interface ports let you plug in dot-matrix and letter-quality printers, as well as other peripherals.

Compare the H-100's exceptional capabilities with other desktop computers:

| COMPUTER | Heathkit H-100 | IBM Personal Computer | Apple III |
|------------------------------|-----------------------------|--|-----------------------|
| MICROPROCESSORS | | | |
| 16-bit: | 8088 | 8088 | |
| 8-bit: | 8085 | | 6502 |
| RANDOM ACCESS MEMORY: | | | |
| Minimum: | 128KB | 16KB | 128KB |
| Maximum: | 768KB | 576KB | 256KB |
| FLOPPY DISK STORAGE: | | | |
| Per Diskette: | 320KB | 320KB | 140KB |
| Maximum Internal: | 640KB | 640KB | 140KB |
| 8 Floppy Support: | Standard | — | — |
| EXPANSION SLOTS: | Five S-100 (four available) | Five (three available) | Eight |
| I/O PORTS: | | | |
| Parallel: | 1 | Optional | — |
| Serial: | 2 | Optional | 1 |
| VIDEO DISPLAY: | | | |
| Line Columns: | 25 x 80 | 25 x 80 | 24 x 80 |
| Pixels Colors: | 640 x 225 (8 colors) | 640 x 200 (2 colors) 320 x 200 (4 colors) | 560 x 192 (16 colors) |
| OPERATING SYSTEMS: | CP/M-85 Z-DOS (MS-DOS) | CP/M-86 PC-DOS (MS-DOS) UCSD P-System | Apple SOS |

Information current as of 8/31/82.

External disk storage available soon.

Learn by building. When you build and operate the H-100, you learn more about this sophisticated computer system and its unique 16-bit/8-bit software capabilities.

Learn from outstanding documentation. One of the most important parts of any computer system is documentation and Heathkit documentation is among the industry's best. Our instruction and operating manuals are fully detailed, in the world-famous Heathkit tradition.

Learn by doing. Many of our software programs come with a complete set-up and operating manual. More complete than most other software documentation, each manual not only tells you what the program will do it shows you the easiest way to accomplish each task.

We back you all the way. With Heathkit computer products, technical assistance and expertise is as close as your telephone – or the nearest Heathkit Electronic Center. Complete technical assistance and service is available at over 60 locations nationwide.

Buy from a leader. When you choose a Heathkit computer, you get the backing and reliability of the world's leader in quality electronic kits for over 50 years! You can count on us for quality, service, reliability and value at kit prices that give you more computer for your dollar!

See the H-100 in action. Visit your nearby Heathkit Electronic Center, which has the world's first



Always in graphics mode, you can control each of the H-100's 144,000 screen dots! (Color graphics optional)

16-bit/8-bit computer kit, peripherals and software programs on display. See your telephone white pages for the nearest store location. Or mail the coupon today for a FREE, full-color Heathkit computer catalog.

CLIP COUPON AND MAIL TODAY TO:

**Heath Company, Dept. 334-994
Benton Harbor, MI 49022**

Please send my FREE Computer Catalog, with details on the new 16-bit/8-bit H-100 Computer Kit, today!

Name

Address

City State

CP-218 Zip

Heathkit Electronic Centers are units of Veritechnology Electronics Corporation. Heath Company and Veritechnology Electronics Corporation are subsidiaries of Zenith Radio Corporation. Prices, product availability and specifications are subject to change without notice.

Heathkit
Heath
Company

EQUIPMENT REPORTS

Voicetech Industries Speech Synthesizer Kit



CIRCLE 103 ON FREE INFORMATION CARD

| VoiceTech Speech Synthesizer | |
|------------------------------|--------------------------|
| OVERALL PRICE | ████████████████████ |
| EASE OF USE | ██████████████████ |
| INSTRUCTION MANUAL | ██████████████████ |
| PRICE / VALUE | ██████████████████ |
| | 1 2 3 4 5 6 7 8 9 10 |
| | Poor Fair Good Excellent |

THOSE OF US WHO ARE INTO ELECTRONICS as well as computers enjoy the best of both worlds. Have you ever wondered

how computerists who are not electronically oriented get along? You have to assume either that they cannot enjoy the

full benefits of their computers or that they have fat wallets.

We, on the other hand, usually won't hesitate to pick up a soldering iron to build some add-on for our systems. We'll even take the covers off and go inside our machines to make a modification or repair now and then. What that means is that we can keep the expense of maintaining and expanding our computers relatively low.

Nonetheless, there is one computer application that, because of its cost, has been off limits even to builders. That application is speech synthesis. There are few computerists who would not at least like to experiment with adding speech capability to their systems. Many also have specific needs for computer speech; among the fields where it might be useful are early childhood education, working

TRITON MARKETING Corp.
679 REMSEN AVENUE
BROOKLYN, N.Y. 11236

We Accept Mastercard and Visa

TOLL FREE HOT LINE
1-800-221-6535
1-212-345-8000

MICROWAVE TV



DCV - 200

- Ideal for Medium Signal Areas
- 46 dB System Gain
- 1.0-2.7 GHz
- Built in A/B Switch
- All Cable & Hardware

== \$129.95 ==

MDC - 23D

- Commercial Styling
- 2 Microwave Stages
- 53 dB System Gain
- 2.1-2.6 GHz
- Built in A/B Switch
- All Cable & Hardware

== \$149.95 ==



MDC - 23P

- 3.75 sq. ft. Parabolic
- 2 Microwave Stages
- 57 dB System Gain
- 2.1-2.6 GHz
- Built in A/B Switch
- All Cable & Hardware

== \$199.95 ==



**WE CARRY A COMPLETE LINE OF
CABLE TV CONVERTERS & DECODERS**

SATELLITE TELEVISION SYSTEMS



TRITON:

**A NEW APPROACH
TO
SATELLITE TV**

DON'T BUY LESS SYSTEM THAN YOU WANT, OR MORE THAN YOU NEED. ONE PHONE CALL WILL INSURE THAT YOUR SATELLITE DOLLARS ARE WELL SPENT.

ALL TRITON SYSTEMS ARE EXPANDABLE. START WITH THE "ADVENTURER" AND YOU CAN ADD COMPONENTS AS YOUR NEEDS CHANGE.

NO SYSTEM IS COMPLETE UNTIL YOU DECIDE IT IS.....

| | | |
|-------------|--|-------------------|
| ADVENTURER: | 10' fiberglass with pole polar mount, Avantek 120 ⁰ K LNA, Gillaspie 7600A receiver, electronic scaler feed, 100' wire and instructions. | \$ 2275.00 |
| STARGAZER: | The "ADVENTURER" plus East/West motor drive. | 2625.00 |
| STATESMAN: | The "ADVENTURER" plus a programable motor drive. | 3025.00 |
| PERFORMER: | The "STATESMAN" with a stereo processor for all stereo formats. | 3375.00 |
| EXECUTIVE: | The ultimate system with wireless remote control. Featuring a 10' fiberglass reflector, pole polar mount, IR remote, auto polarization of Avantek 100 ⁰ K LNA, all stereo formats, programable motor drive. | 3750.00 |
| URBANA: | A true roof mountable system weighing only 160 pounds. With an Avantek 120 ⁰ K LNA, Gillaspie 7600A receiver, scaler feed and rotator, East/West motor drive, 100' wire and instructions. | 3300.00 |

CIRCLE 18 ON FREE INFORMATION CARD

Slashes Fordham Lowers Prices on **B&K PRECISION** Test Equipment

Now Fordham is passing on to customers the hugest savings possible on test instruments. To help celebrate the opening of our new 40,000 square foot facility on Long Island, we've purchased an extra large inventory of B&K Precision products.

We're offering the quality of name brand products and the benefits of our volume purchasing power. While supplies last we guarantee these unbelievably low prices.

3 1/2 Digit LCD Autoranging DMM

Model 2845
Reg. \$175.00

Now **\$79⁹⁵** each

B&K PRECISION

- Fully automatic, auto-ranges on all functions.
- Range lock holds any range.
- 0.1% accuracy.
- Fast reading.
- 0.5" LCD display.
- Autozeroing.
- Autopolarity on all ranges.
- Audible continuity indicator.
- Varistor and fuse overload protection.
- RF shielded.
- Meets UL 1244 safety standards.



8-Trace, 4 Channel 100 MHz Dual Time Base Scope

Model 1500

Reg. \$2575.00

Now **\$1489⁰⁰** each

B&K

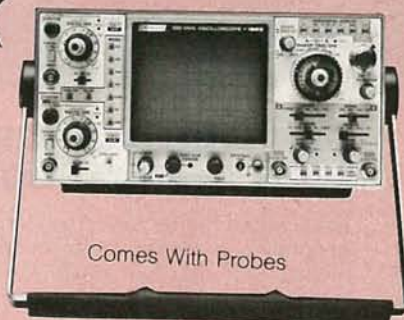

Comes With Probes

- 100 MHz response, 3.5nS rise time • 2nS/div. sweep rate with 10X magnifier • Trigger views or four separate inputs • Dual time base • 1 M ohm inputs or 50 ohm inputs • 1mV/div sensitivity to 100 mHz • CH 1 frequency counter output • Delayed sweep, 20 nS to 0.5 seconds • Alternate timebase
- Switching power supply • Selectable chop frequencies • Voltage and current probe calibrators.

Low Distortion Function Generator

Model 3010
Reg. \$220.00

Now **\$187⁵⁰** each



- Generates sine, square and triangle waveforms • Variable amplitude and fixed TTL squarewave outputs • 0.1 Hz to 1 mHz in six ranges • Typical sine wave distortion under 0.5% from 0.1 Hz to 100 kHz • Variable DC offset for engineering applications
- VCO external input for sweep-frequency tests.

Dynapeak Transistor Tester

Model 520B
Reg. \$239.00

Now **\$199⁷⁵** each



- Fast testing • Hi/Lo drive • Works in-circuit when others won't • Identifies leads of bipolar and FET's • Random lead connection • Audible test OK 'beep'
- Automatic NPN/PNP and Si/Ge identification.

CRT Restorer/Analyzer

Model 467

Reg. \$495.00

Now **\$420⁷⁵** each



- Restores color and b/w picture tubes like new! Uses the most powerful restoration method known with minimal danger to the CRT • Exclusive multiplex test technique tests all three guns of color CRT's simultaneously under actual operating conditions, even CRT's with common G1 and G2, with real dynamic tests • Instant, automatic tracking.

FOR ORDERING OR PRICING ON OTHER TEST EQUIPMENT

Call Toll Free
(800) 645-9518

N.Y.S. (800)832-1446

FORDHAM

260 Motor Parkway, Hauppauge, N.Y. 11788



■ Master Charge ■ VISA ■ COD
■ Money Order ■ Check
\$50.00 minimum order
COD's extra (required 25% deposit)

| | |
|---|---------------------------------|
| N.Y. State residents add appropriate sales tax. | ADD FOR SHIPPING AND INSURANCE |
| | \$250.00 \$4.50 |
| | \$251.00 to 500.00 6.50 |
| | \$501.00 to 750.00 8.50 |
| | \$751.00 to 1000.00 12.50 |
| | over 1000.00 15.00 |

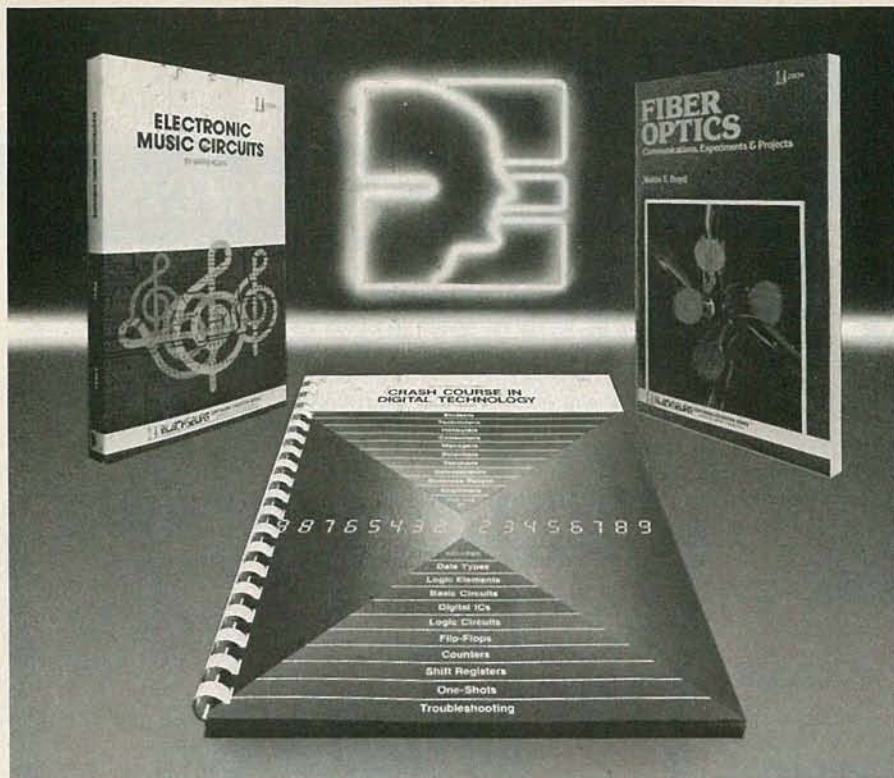

GRAB HOLD OF 1983 TECHNOLOGY WITH A SAMS BOOK!

Learn about digital basics, working with fiber optics, generating electronic music, building intrusion alarms, managing home energy with your microcomputer, and more! Find out how YOU can do them all with these Sams Books:

HOWARD W. SAMS CRASH COURSE IN DIGITAL TECHNOLOGY is our newest Sams Crash Course! It quickly provides you with digital circuit fundamentals, including state-of-the-art components, ICs, techniques, methods, and developments. No prior knowledge of digitals is necessary! No. 21845, \$20.95

BUILDING AND INSTALLING ELECTRONIC INTRUSION ALARMS (3rd Edition) helps you build your own protection against robbery, burglary, and eavesdropping in your home or car. Also covers personnel identification and verification, as well as detection of concealed weapons! No. 21954, \$10.95

FIBER OPTICS COMMUNICATIONS, EXPERIMENTS & PROJECTS clearly explains light-beam communication fundamentals, introduces you to the simple electronic devices used, and lets you participate in transmitting and receiving both voice and music by means of a light beam travelling along a slender glass fiber! No. 21834, \$15.95

ELECTRONIC MUSIC CIRCUITS shows you how to build a custom electronic music synthesizer, outlines numerous other designs, and then shows you how to modify them to achieve particular responses. Many of the circuits can be used for special effects with guitars and other musical instruments. No. 21833, \$16.95

COMPUTER-ASSISTED HOME ENERGY MANAGEMENT helps you create a working energy-monitor for your home, using your microcomputer coupled to inexpensive temperature sensors and other easily built system hardware. Includes all details, necessary programs, documentation, and more. No. 21817, \$15.95

To order your Sams Books, call 800-428-3696 or 317-298-5566 and reference AD255.

HOWARD W. SAMS & CO., INC.
4300 West 62nd Street • P.O. Box 7092 • Indianapolis, IN 46206
Offer good in USA only and expires 6/30/83. Prices subject to change without notice. In Canada, contact Lenbrook Industries, Ltd., Scarborough, Ontario.

with the handicapped, and process monitoring. The problem, however, was that the synthesizer IC alone could cost upwards of \$70.00.

But speech synthesis no longer costs an arm and a leg. Voicetech Industries (PO Box 499, Fort Hamilton Station, Brooklyn, NY 11209) has come to the rescue with an inexpensive (the introductory price is \$24.95) "starter kit" of parts for building your own synthesizer. The accompanying manual is very well written and provides all the information needed to enter that fascinating field.

The manual is called *How To Make Your Computer Talk For Under \$50* and it tells you how to do just that. The first section contains background information on phonemes (the sounds that make up speech) and allophones (the acoustic signals for those sounds). That information allows you to use the synthesizer more effectively by teaching you how to create words out of their basic sounds.

The second section includes programs for Radio Shack and Apple computers. Those are complete, with thorough comments and some sample applications. Although the programs are rather rudimentary, they provide understandable algorithms that are easy to use.

The final section contains schematics for three synthesizers. Those synthesizers vary in complexity, but none is at all difficult to build. The kit you buy will depend upon which computer you are using, but each includes a 3.12-MHz crystal and a General Instruments SP0256 speech-synthesizer IC; all sell for the same price.

To complete your kit, you'll need to buy fewer than 20 additional components. Those are all readily available and include things like resistors, capacitors, a speaker, and an LM386 audio-amplifier IC. For those with depleted junkboxes, the parts are priced at Radio Shack for just under \$25, including the card-edge connector and ribbon cable. That proves that the cost does indeed come to under \$50.00.

Construction and use

There's nothing critical in building the synthesizer. In fact, you can throw one together on a solderless breadboard in less time than it takes to read about it. Once that's done, just enter the program and you're all set to go.

You'll get speech the first time you run the program. A somewhat non-human, but quite intelligible voice says: "Welcome to Voicetech, my name is Chatterbox." After you replay that a few times for effect, you are ready to try some more ambitious tasks.

The process of programming words is not at all difficult. Allophones are selected from the chart provided (which also has examples) and typed on the keyboard. Thanks to the program's error-



VIDEO EQUIPMENT

QUALITY • LOW PRICES

OFF-THE-SHELF DELIVERY

from **FORDHAM** of course.

BUY OF THE MONTH



MODEL V-1880

BP STABILIZER/IMAGE ENHANCER/RF CONVERTER/VIDEO FADER/2-WAY DISTRIBUTION AMPLIFIER

OUR PRICE **\$135.00** each

Most versatile video processor. Contains five units in one: stabilizer (video guard remover); image enhancer; video to RF converter; video fader; and dual output distribution amplifier.

Stabilizer Will correct entire range of copy guard distortion such as jitter, vertical roll or black bar travelling through picture.

Enhancer Lets you attain best picture for your own preference.

RF Converter Allows your TV set to receive video and audio signals from your image enhancer, guard stabilizer, video camera, computer, VCR, etc. The direct video signal from any video component can be fed into the V-1880 and converted to a usable RF signal that can go to your TV antenna terminals.

Video Fader Used to produce professional fade ins and fade outs.

BP VIDEO GUARD STABILIZER

MODEL V-1875



OUR PRICE **\$45.00** each

Has self contained A&B and bypass switch. Many movies, concerts and special programs for sale or rental are copy guarded. This removes copy guard and allows you to make copies. Many TV sets will not play prerecorded tapes because copy guard causes picture to roll and jitter, turn to snow or disappear. Video Guard Stabilizer removes copy guard from signal.

BP VIDEO GUARD STABILIZER/RF CONVERTER

MODEL V-1877



OUR PRICE **\$69.95** each

Same as above but with a built-in RF Converter that gives the model V-1877 an RF output which can be fed directly to the antenna terminals of a TV set. This enables you to remove the copy guard from a pre-recorded tape and view it on a TV using only a VCR.

Use as an RF Converter only. Used in conjunction with your TV, you can feed direct audio and video signals from any video device such as video camera, computer, portable VCR, etc.

BP VIDEO COMMAND CENTER

MODEL V-4803

OUR PRICE **\$59.95** each

A switcher that can accept 6 inputs and direct them to 3 outputs. Utilizes switch similar to one used on home VCR's. You avoid signal loss incurred by using splitters.



JERROLD 60 CHANNEL CORDLESS TV CONVERTER

MODEL DRX-3-105

CALL FOR PRICES



- Receive up to 60 TV channels
- Remote TV Control
- Attach to any age or model TV in minutes.
- No tools required.
- On/Off button.
- Channel selection.
- Channel Stepping.
- Fine Tuning.

JERROLD JRX TV REMOTE CONVERTER

MODEL JRX-3C105 (SWITCH)

OUR PRICE **\$79.95** each

Consists of two units - a receiver and transmitter. 20 ft. connecting cord is detachable at one end to help you position the unit. May be attached to any age or model TV in minutes. No tools required.

- Receive up to 36 channels.
- Remote TV control.



BP VIDEO CONTROL CENTER

MODEL V-4802

OUR PRICE **\$19.95** each

Provides remote control access of all Video, TV or Cable, inputs to TV or Big Screen TV from one location by flipping switch.

- One output, your TV set or Big Screen TV
- Four inputs
- Completely passive, i.e. no AC power required to operate
- Auxiliary input and output provides added flexibility.



BP UHF CONVERTER FOR TV AND VTR

MODEL V-5736

OUR PRICE **\$24.95** each
5 FOR **\$100.00**

Use your VCR to its maximum capability. Record VHF, UHF, Cable or Pay TV while watching any other mode.

- FEATURES**
- 36 channels
 - Allows complete programming of VTR
 - Super color quality
 - Watch or record any combination of selectable channels.
 - Receives midband, superband/Pay and all VHF channels on UHF.
 - For Beta/VHS type recorders or TV set
 - Record and use TV's remote control.



BP IMAGE ENHANCER

MODEL V-1860

Dramatically improves performance of video cameras and VCR's, (off-the-air or second generation recordings), by compensating for deterioration of detail and sharpness. Includes video distribution amplifier with two video outputs, allowing you to make two copies at once without loss in signal level.



OUR PRICE **\$59.95** each

BP RF CONVERTER/MODULATOR

MODEL V-1885

OUR PRICE **\$39.95** each

Allows your TV to receive video and audio signals from image enhancer, guard stabilizer, video camera, computer, VCR, etc.

The outputs of many video components cannot be directly hooked up to the VHF antenna terminals on your TV set. This problem is solved by using the Model V-1885 RF Converter. Converts video signal from any video component to adjustable RF signal at antenna terminals. Allows your VCR output to feed two TV sets at the same time, with virtually no signal loss.



FORDHAM
260 Motor Parkway, Hauppauge, N.Y. 11788

Master Charge
VISA
COD
Money Order
Check

N.Y. State residents add appropriate sales tax.

ADD FOR SHIPPING AND INSURANCE:
\$250.00 \$4.50
\$251.00 to 500.00 6.50
\$501.00 to 750.00 8.50
\$751.00 to 1000.00 12.50
over 1000.00 15.00

COD's extra (required 25% deposit)

TOLL FREE (800) 645-9518
in N.Y. State call 800-832-1446

E-Z CIRCUIT™ Introduces

by Bishop Graphics, Inc.

"THE ANYTHING BOARD"



And You Can Build It "Instantly" With One Of E-Z CIRCUIT's Professional PC Design Kits... Ideal For Personal Computer Applications!

An E-Z CIRCUIT "Anything Board" is just that. Anything you want it to be. Just use your imagination, plus an E-Z CIRCUIT Professional PC Design Kit, and you can build an *instant* one-of-a-kind PC board to accomplish virtually anything you want — at a substantial savings (up to 40%) over pre-etched boards on the market today. Ideal for building special function interfaces for personal computer applications. You can also prototype, repair or modify existing circuitry. And there's *NO* artwork, *NO* photography, *NO* screening, *NO* etching!

The secret? E-Z CIRCUIT's unique, pressure-sensitive COPPER mounting configurations and tapes that, when applied to your PC board, work like conventional circuitry. You solder the components directly to them.

RADIO-ELECTRONICS Editor "Doc" Savage says this about the E-Z CIRCUIT system: "Those patterns are not for making artwork — they are copper. When you have pressed them down on a board, you are ready to mount the circuit components, solder them in place and turn on the power! That is what I call instant PC boards." "Having used this E-Z CIRCUIT system, I can report that it is quick, easy and reliable. It is the best way I have found to make one or two-of-a-kind PC boards."

Choose from four E-Z CIRCUIT Kits (see chart at right).

For The Name Of Your Local E-Z CIRCUIT Distributor, or to place your order . . .

CALL TOLL-FREE (800) 782-8766
(8 to 5 PST Mon. thru Fri.)
(In Calif., Hawaii and Alaska, call (213) 991-2600)

E-Z CIRCUIT™
by Bishop Graphics, Inc.

*Add \$4.00 for postage and handling, Calif. residents add 6% sales tax.

5388 Sterling Center Dr., Dept. RE2, Westlake Village, CA 91359 U.S.A.



Welcomed On Direct Orders

EACH KIT CONTAINS a full assortment of pressure-sensitive copper design products as listed below, *PLUS* a special purpose PC board with matching connector patterns — **OVER 200 PIECES!**

FOR APPLE II APPLICATIONS

Order Kit Catalog No. 
EZ8954 . . . \$63.20*

FOR S-100 APPLICATIONS

Order Kit Catalog No. 
EZ8953 . . . \$68.20*

FOR STANDARD BUS APPLICATIONS

Order Kit Catalog No. 
EZ8952 . . . \$62.80*

FOR EUROCARD APPLICATIONS

Order Kit Catalog No. 
EZ8951 . . . \$67.50*

| DESCRIPTION | QUANTITY |
|---|----------------|
| Terminal (Donut) Pad Strips .300" Center-to-Center | 5 Strips |
| Terminal (Donut) Pad Strips .200" Center-to-Center | 5 Strips |
| Conductor Strip — .031" LW | 1 Strip |
| Discrete Component Strip | 1 Strip |
| DIP Pattern, Triple Pad | 3 Strips |
| DIP Pattern, Four Pad | 1 Strip |
| Donut Pads — .125" x .040" | 96 Symbols |
| Copper Tape — .031", .062", .100" | 1 Roll ea. |
| Insulating Tape — .200" | 1 Roll |
| Distribution Strip — .400" Center-to-Center Single Pad | 3 Strips |
| Distribution Strip — .100" Center-to-Center Single Row | 3 Strips |
| T0-5 Pattern, 4, 6, 8, 10 & 12-lead | 10 Symbols ea. |
| Power Transistor Mtg. Pattern | 5 Symbols |
| SCR Stud Mtg. Pattern | 5 Symbols |
| X-acto Knife Holder & Blade | One |
| Alignment Pins | Four |

trapping and easy-editing features, you can have your computer saying your name in a couple of minutes. From there on, the sky is the limit—mix and match the available 64 allophones as you wish.

You need not be concerned about the quality of the Voicetech synthesizer or the intelligibility of its speech. With the two-inch speaker we got from Radio Shack, speech was quite intelligible, but when a better speaker was used, the synthesizer put out speech that was at least as good as that of any microcomputer synthesizer this reviewer has ever heard. The speech quality is higher than some off-the-shelf models that cost a good bit more. In addition, it is relatively easy to modify the audio-filter components to produce a sound that best matches your speaker, preferences, and needs.

Adding speech to enhance your programs is an easy matter. The speech is held in simple one-dimensional arrays. When words are needed, one or more of the appropriate arrays are fed through a short "talk" subroutine.

Of course, neither this nor any other speech synthesizer is capable of producing speech comparable to that from a TV or recorder—the speech has a definite "machine-made" quality to it and people seem to vary in their adaptability to it. Some hear it clearly and distinctly right from the first, while others seem to require a bit of time before they get used to it. In any case, the Voicetech speech-synthesizer kit and manual provide the least expensive way to get good quality speech from your computer. **RE**

Anders Model CM-100 Capacitance Instrument



CIRCLE 104 ON FREE INFORMATION CARD

| Anders | | CM-100 | | | | | | | | | | | |
|--------------------|--|--------|---|------|---|---|------|---|---|-----------|----|--|--|
| OVERALL PRICE | | | | | | | | | | | | | |
| EASE OF USE | | | | | | | | | | | | | |
| INSTRUCTION MANUAL | | | | | | | | | | | | | |
| PRICE/VALUE | | | | | | | | | | | | | |
| | | 1 | 2 | 3 | 4 | 5 | 6 | 7 | 8 | 9 | 10 | | |
| | | Poor | | Fair | | | Good | | | Excellent | | | |

ALTHOUGH THE CAPACITANCE METER IS not usually mentioned in discussions of test instruments, it can be a very valuable

addition to your test bench. One particularly useful meter is the model *CM-100 Capacitance Instrument* from Anders Precision Instrument Co., Inc. (4 Bridge St. Plaza, PO Box 75, Willimantic, CT 06226). It not only can measure capacitance values in or out of circuit, but it can also measure capacitance current-leakage—the usual cause of capacitor failure.

The *CM-100* measures capacitance values from 1 pF to 25,000 μ F in seven ranges: pF \times 10, nF \times 0.1, nF, nF \times 10, μ F \times 0.1, μ F, and μ F \times 5. For most capacitors, the measurement procedure is straightforward. You plug one end of the supplied test leads into the CAPACITOR jacks and clip the other end onto the capacitor (you must make sure that polarized capacitors are oriented correctly). If you do not know the approximate value of the capacitor you are measuring, start at the highest range (μ F \times 5) and work your way down. To make the actual measurement, hold in the CAPACITANCE button. Within eight seconds you will be able to read the value on the front panel's mirrored, 3½-inch, analog meter. That meter is marked from 0 to 100 in increments of two. The range switch provides you with the proper multiplier.

For capacitors larger than 5000 μ F, the measurement procedure is different—an external 0-to-10-volt meter is required. That meter is attached to the EXTERNAL METER jacks and the CAPACITANCE button is held in as before, but now the external meter is read. The voltage reading is converted into units of capacitance by using the External Range Calibration Curve that is found in the instruction manual. Be cautious when hooking your meter up to the *CM-100* to make capacitance measurements. When the positive voltmeter-lead was attached to the red EXTERNAL METER jack on our test model, the needle deflected backwards.

The NULL control is used to null out the capacitance of the test leads and the *CM-100* itself. It can null up to 10% of the measurement on any scale. Normally, the NULL control is turned fully counterclockwise, but when using the lowest range (pF \times 10), you must adjust the control so that the meter reads "2" without the capacitor connected.

When measuring capacitances greater than about 10 μ F, the meter's needle will fluctuate between \pm 5%. The instruction manual points out that a 10,000- μ F capacitor can be wired across the meter terminals to reduce the fluctuation. Although the time it takes to make a measurement is increased when the capacitor is attached, the meter is easier to read with it in place.

The instruction manual also includes a schematic diagram, a parts list, a parts-placement diagram for the *CM-100*, and test and calibration instructions. A simple weak-battery test is also described in *continued on page 38*

FORDHAM CUTS PRICES ON HITACHI SCOPES

MINI-PORTABLE DUAL TRACE



Model V-209
3-way power supply, compact, light-weight package • High sensitivity 1 mV/div at 10m Hz and fast sweep times 50 ns/div • Built-in TV sync separation circuit/TV-V & TV-H modes • Auto-focus • Comes with probes.

20 MHz Dual Trace



Model V-202F
.55" square CRT • Vertical sensitivity 5m V/div to 5 V/div and 1m V/div to 1V/div with 5X amplifier • Display modes Ch1, Ch2, Dual, Add, Diff. • Comes with probes.
Model V-203F - Same as above but with Delayed Sweep.

35 MHz DUAL TRACE



Model V-352F
Vertical sensitivity 5m V/div to 5V/div and 1m V/div to 1V/div with 5X amplifier • Trigger modes Automatic, Normal, TV(+), TV(-) • Comes with probes.
Model V353F - Same as above but with Delayed Sweep.

60 MHz DUAL TRACE DELAYED SWEEP



Model V-650F
High sensitivity • 1 mV/div (10MHz) • 5 ns/div sweep rate • 3rd channel display (trigger view) • Variable trigger hold-off • Full TV triggering • Single sweep • Automatic focus correction • Comes with probes.

100 MHz QUAD TRACE DELAYED SWEEP



Model V-1050F
Large, bright 8x10 cm screen • Quad trace operation/Ch1, Ch2, A trigger and B trigger • High sensitivity 500 μ V/div (5 MHz) • Full TV triggering • Comes with probes.

FREE DVM

\$80 Value



BP Model DVM-532
Full autoranging 3-1/2 digit LCD • Built-in continuity buzzer • Easy to read, 1/2" digit LCD display • Overload protection • Low battery indication.

CALL FOR SPECIAL INTRODUCTORY PRICES
TOLL FREE (800) 645-9518 in N.Y. State 800-832-1446

FORDHAM



- Master Charge
- VISA
- COD
- Money Order
- Check

260 Motor Parkway, Hauppauge, N.Y. 11788

“If you’re going to learn electronics, you might as well learn it right!”



“Don’t settle for less. Especially when it comes to career training...because everything else in your life may depend on it. That’s why you ought to pick CIE!”

You've probably seen advertisements from other electronics schools. Maybe you think they're all the same. They're not!

CIE is the largest independent home study school in the world that specializes exclusively in electronics.

Meet the Electronics Specialists.

When you pick an electronics school, you're getting ready to invest some time and money. And your whole future depends on the education you get in return.

That's why it makes so much sense to go with number one... with the specialists... with CIE!

There's no such thing as bargain education.

If you talked with some of our graduates, chances are you'd find a lot of them shopped around for their training. Not for the lowest priced but for the best. They pretty much knew what was available when they picked CIE as number one.

We don't promise you the moon. We do promise you a proven way to build valuable career skills. The CIE faculty and staff are dedicated to that. When you graduate, your diploma shows employers you know what you're about. Today, it's pretty hard to put a price on that.

Because we're specialists, we have to stay ahead.

At CIE, we've got a position of leadership to maintain. Here are some of the ways we hang onto it...

Our step-by-step learning includes "hands-on" training.

At CIE, we believe theory is important. And our famous Auto-Programmed® Lessons teach you the principles in logical steps.

But professionals need more than theory. That's why some of our courses train you to use tools of the trade like a 5 MHz triggered-sweep, solid-state oscilloscope you build yourself—and use to practice troubleshooting. Or a Digital Learning Laboratory to apply the digital theory essential to keep pace with electronics in the eighties.

Our specialists offer you personal attention.

Sometimes, you may even have a question about a specific lesson. Fine. Write it down and mail it in. Our experts will answer you promptly in writing. You may even get the specialized knowledge of all the CIE specialists. And the answer you get becomes a part of your permanent reference file. You may find this even better than having a classroom teacher.

Pick the pace that's right for you.

CIE understands people need to learn at their own pace. There's no pressure to keep up... no slow learners hold you back. If you're a beginner, you start with the basics. If you already know some electronics, you move ahead to your own level.

Enjoy the promptness of CIE's "same day" grading cycle.

When we receive your lesson before noon Monday through Saturday, we grade it and mail it back—the same day. You find out quickly how well you're doing!

CIE can prepare you for your FCC License.

For some electronics jobs, you must have your FCC License. For others, employers often consider it a mark in your favor. Either way, it's government-certified proof of your specific knowledge and skills!

More than half of CIE's courses prepare you to pass the government-administered exam. In continuing surveys, nearly 4 out of 5 CIE graduates who take the exam get their Licenses!

Associate Degree

Now, CIE offers an Associate in Applied Science Degree in Electronics Engineering Technology. In fact, all or most of every CIE Career Course is directly creditable towards the Associate Degree.

Send for more details and a FREE school catalog.

Mail the card today. If it's gone, cut out and mail the coupon. You'll get a FREE school catalog plus complete information on independent home study. For your convenience, we'll try to have a CIE representative contact you to answer any questions you may have.

Mail the card or the coupon or write CIE (mentioning name and date of this magazine) at: 1776 East 17th Street, Cleveland, Ohio 44114.

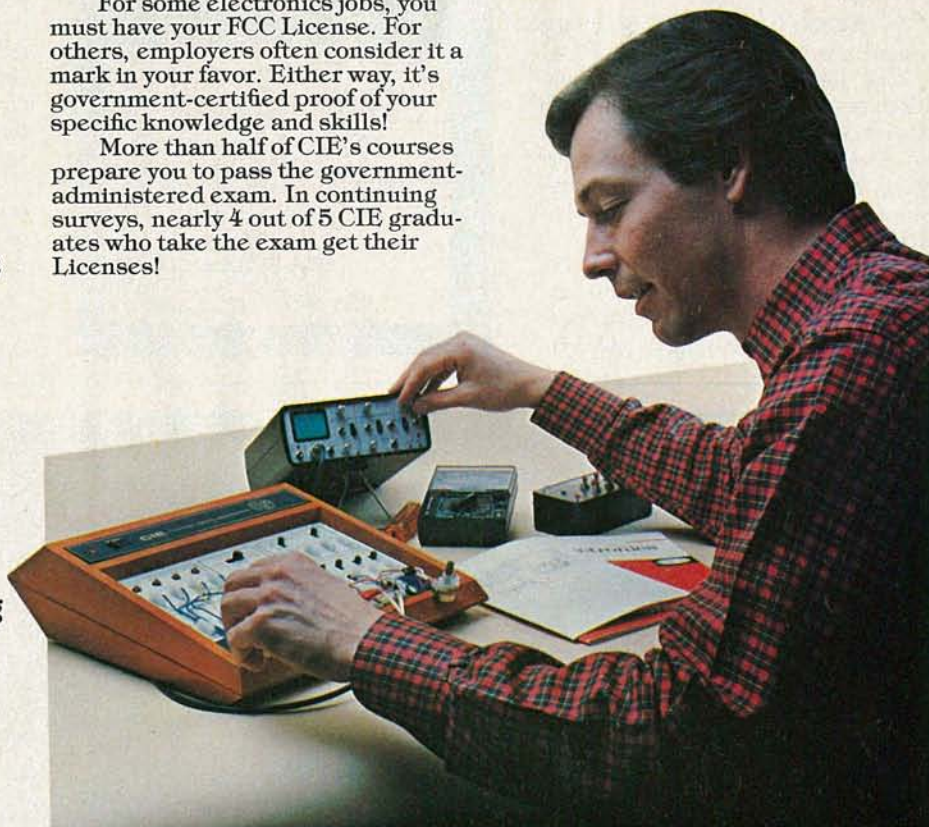

CIE Cleveland Institute of Electronics, Inc.

1776 East 17th Street, Cleveland, Ohio 44114

Accredited Member National Home Study Council

YES... I want the best of everything! Send me my FREE CIE school catalog—including details about the Associate Degree program—plus my FREE package of home study information. RE 56

Print Name _____

Address _____ Apt. _____

City _____

State _____ Zip _____

Age _____ Phone (area code) _____

Check box for G.I. Bill information: Veteran Active Duty

MAIL TODAY!

EQUIPMENT REPORTS

continued from page 32

tail in the fifteen-page manual.

Measuring capacitance current-leakage also requires an external 0-to-10-volt meter. That meter and the capacitor are hooked up as before. (Except now, the positive voltmeter lead is hooked up to the red jack.) To make the measurement, the OUTPUT button is held in and the voltmeter is watched to determine the time it takes for the voltage to decrease to one-half of its original value. The leakage can then be determined by using the equation $i = C \Delta V / \Delta t$. However, exact measurements of leakage are usually not necessary, and leaky capacitors can be easily spotted—especially when using an analog meter.

The CM-100 is primarily a bench-top instrument in an attractive $7\frac{1}{4} \times 7\frac{1}{2} \times 4\frac{1}{2}$ inch aluminum and plastic walnut-grained case. It is powered by two 9-volt batteries, so, although it won't fit in your shirt pocket, it is portable. Remember though, you will need the chart in the instruction manual to measure capacitances greater than 5000 μF .

Besides measuring component values, the unit can be used to measure the capacitance between circuit-board traces (that "hidden" problem can often lead to

poor circuit performance) or to find the distance to a short (or open) in a coaxial cable. The device is also useful for checking large quantities of components—it will not only find those that are mis-marked or have changed value, but also ones that suffer from current leakage—try doing that with a digital meter!

The CM-100 is available from the manufacturer for \$89.95, plus \$3.50 shipping and handling. **R-E**

Kenwood R-1000 Shortwave Receiver



CIRCLE 105 ON FREE INFORMATION CARD

| Trio-Kenwood | | R-1000 | | | | | | | | | | | | |
|--------------------|--|--------|---|---|------|---|---|------|---|---|-----------|--|--|--|
| OVERALL PRICE | | | | | | | | | | | | | | |
| EASE OF USE | | | | | | | | | | | | | | |
| INSTRUCTION MANUAL | | | | | | | | | | | | | | |
| PRICE/VALUE | | | | | | | | | | | | | | |
| | | 1 | 2 | 3 | 4 | 5 | 6 | 7 | 8 | 9 | 10 | | | |
| | | Poor | | | Fair | | | Good | | | Excellent | | | |

NOT TOO MANY YEARS AGO, SHORTWAVE listening required a lot of patience. Most often, that was because of the receiver itself. Though many were superhetro-dyne types, their dials were often crowded because of their poor selectivity and it was nearly impossible to find a specific frequency without a great deal of patience and/or luck. Also, those radios—especially the less expensive ones—tended to drift. So, if someone was listening to one frequency and left the rig for a while, he could come back and find it several kilohertz away.

The situation has changed in the last 10 years. Now shortwave receivers use phase-locked-loop tuning, sport digital displays, have excellent sensitivity and good selectivity, and have many of the features that were found only on super-expensive top-of-the-line receivers only a few years ago.

Kenwood's R-1000 communications receiver is an example of a modern receiver. It is a general-coverage receiver, covering 200 kHz to 30 MHz, and has three reception modes: AM (both wide and narrow), USB, and LSB/CW.

The heart of this unit includes a highly stable VFO and a phase-locked-loop frequency synthesizer for rock-stable reception. Frequency stability is 2 kHz for the first hour of use, but it settles down to 300 Hz maximum for every 30 minutes thereafter.

3 Models from \$2550.
Tek's toughest!



As with other modern, general coverage receivers, the *R-1000* is relatively compact and lightweight ($12\frac{3}{4} \times 4\frac{1}{2} \times 8\frac{5}{8}$ inches and 12.1 pounds) and has some respectable specifications. In actual use, we found that the performance of the receiver seemed to match its specifications.

Its claimed sensitivity, 10 dB or more $S+N/N$, is 20 μV on the AM-NARROW setting in the 200-kHz to 2-MHz range and is 0.7 μV when set in the SSB mode. In that frequency range, the radio requires a high-impedance antenna (in the vicinity of 1 kilohm). In the 2- to 30-MHz range, with a 50-ohm antenna, the sensitivity figures are 2 μV on AM-NARROW and 0.5 μV on SSB.

As mentioned before, the *R-1000* has both AM-wide and AM-narrow modes. In the AM-wide mode, (which has a 12-kHz, -6-dB bandwidth) local reception can be enhanced with better tone quality. The AM-narrow mode is used when unwanted signals are present near the frequency of the desired signal. In that mode, the receiver's bandwidth is narrowed, and interference is reduced. The -6-dB bandwidth is cut in half to 6 kHz. In use, I found that that setting does help improve AM reception, especially in high-static conditions on the medium-wave frequencies. (Kenwood suggests adding a jumper wire to further narrow the bandwidth of the AM-NARROW position to the same figure as the SSB position.

That indeed is an improvement.)

The image- and IF-rejection figures are also excellent for a general-coverage receiver. The image ratio is claimed to be more than 60 dB, while the IF rejection is better than 70 dB. Those figures are better than those of my ham transceiver! I believe that the *R-1000* could be used as a separate receiver for amateur-radio operation on split frequencies. In fact, an accessory socket in the rear allows you to automatically mute the receiver when the transmitter is keyed.

The -60-dB selectivity figure is 5 kHz and the -6-dB figure is 2.7 kHz. Those figures indicate just how sophisticated general-coverage receivers have become.

The *R-1000* will operate with a variety of antennas, from simple random-length wire antennas to beam antennas. There are three antenna feedpoints, one for the standard SO-239 connector for coaxial cable and the others for simple wire-antenna inputs. All of the antennas are meant to be used in an unbalanced condition, the grounding coming from the radio itself, through a ground-wire input terminal. Interestingly, if a listener wants to listen to frequencies from 200 kHz to 2 MHz, he has to use a separate antenna. The coaxial and short-wave antenna inputs can't be used in that range. However, that's a minor inconvenience.

The receiver is so easy to use that after only a few minutes of studying the own-

er's manual, I was listening not only to foreign shortwave broadcasts, but also to radio amateurs on their frequencies. The manual is complete and gives operating hints, but it is apparently aimed at the "appliance operator" because there is no explanation of theory and although a schematic is included, there is very little troubleshooting help.

A large, green, fluorescent digital frequency display made finding frequencies very easy. Also, setting the receiver's frequency is quite simple. All that is required is a twist of the band switch to set the main frequency in megahertz. Then the larger, easy-turning main tuning knob is twisted to find a particular frequency within its 1-MHz range. The lighted tuning dial is of the analog variety and serves well as a backup for the digital display. You'll find very little backlash in this knob.

Finding the correct mode to use for any type of reception was also easy because the mode switches are well marked and are just to the left of the band switch. A set of pushbutton switches changes the various modes.

The signal-strength meter is a conventional D'Arsonval movement and seems a bit on the generous side. It also points up one area which could stand some improvement. When listening to Morse code transmission, the AGC ac-

continued on page 103

EK 2300 SERIES
PORTABLE OSCILLOSCOPES

THE FIELD
SERVICE SCOPES

Built for field service. Tough enough for the road.

The 2300 Series is unassailable proof that sensitive instruments needn't be delicate. No other scopes are so immune to abuse and to day-to-day wear and tear. They feature 50Gs shock resistance, our highest electromagnetic compatibility, and high-performance

measurement—all in an ultra-durable 17-lb. package.

Bottom line: the lowest life cycle costs of any high performance portable. Thanks to fewer components. Easier access to internal parts. Plus less downtime and fewer back-up instruments re-

quired, as proven by the toughest reliability testing we know of—our own.

All that, and Tek performance too! Select dc to 100 MHz with 5 ns horizontal sweep. 2mV/div vertical sensitivity. Built-in delta time and DMM. This time, get the scopes

that can handle the hard knocks of your business ... wherever the business takes you. Order today—or ask for the full Tek 2300 story! Call toll free:

**Order toll free:
1-800-426-2200
Extension 28**

In Oregon call collect:
(503) 627-9000 Ext. 28

Tektronix®
COMMITTED TO EXCELLENCE

CIRCLE 17 ON FREE INFORMATION CARD

NEW PRODUCTS

For more details use the free information card inside the back cover

ASSEMBLY AID, model *HPCB-15*, is a unique holding stand for aiding all types of electronics and mechanical assembly work. It features two strong alligator clips for reliable holding action, plus quick and easy clamping and release.

Both clips are mounted in ball joints, and the connecting bar is mounted in a third ball

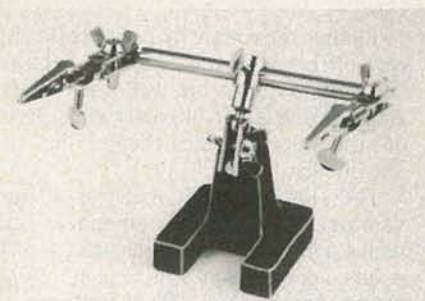

CIRCLE 111 ON FREE INFORMATION CARD

joint, enabling complete articulation and flexibility to suit any task. Finally, all ball joints may be locked in any position, and the entire assembly is mounted in a heavy cast-metal base to provide stability during use. The all-steel construction assures durability.

The model *HPCB* is designed for stuffing PC boards, electronics projects, mechanical work, and model making. It is priced at \$7.95.—**OK Machine and Tool Corporation**, 3455 Conner Street, Bronx, NY 10475.

CONVERSION KIT, model *DVM-1*, is designed for receiver-to-monitor conversion featuring both audio and video interfaces using special-purpose opto-isolators. The model *DVM-1* will permit the user to operate in either a monitor or receiver mode of operation by selecting a switch position. It can be installed in either black-and-white or color sets, and permits the user to obtain high-resolution displays of up to 80 characters-per-line. It is a

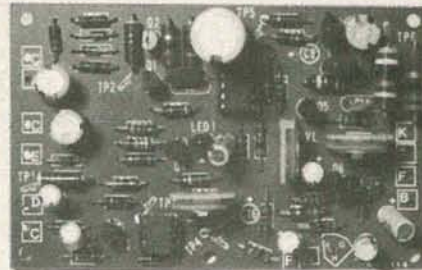

CIRCLE 112 ON FREE INFORMATION CARD

direct-video modification which, in the monitor mode, bypasses the tuner and IF sections of a conventional television set and thus provides the user with a high-quality display. Ghosting, color-shifting, and RF radiation and interference problems are eliminated with the direct-video method. The model *DVM-1* will work with all popular TV receivers presently on the market.

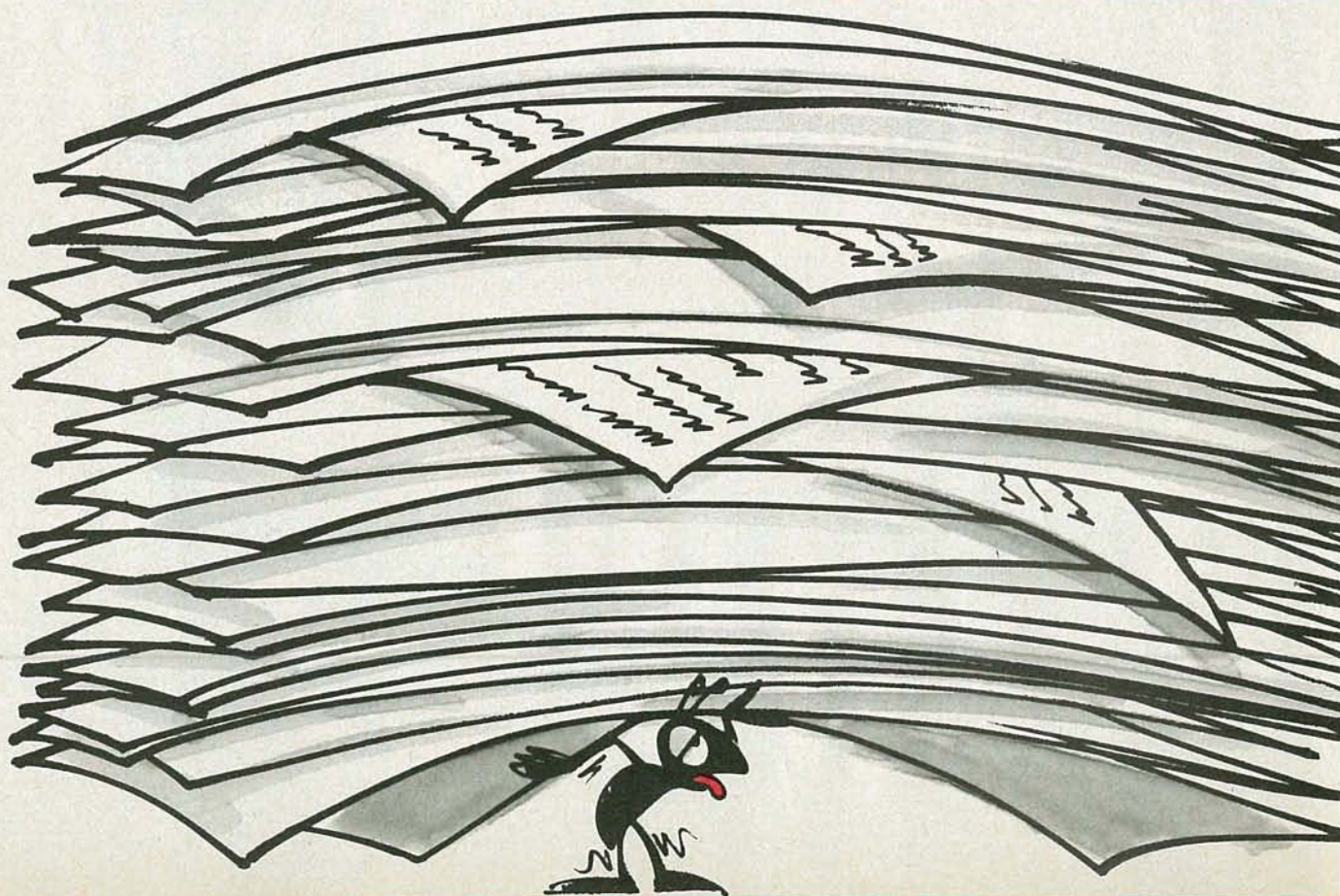

The model *DVM-1* conversion kit is priced at \$64.95.—**V.A.M.P. Incorporated**, 6753 Selma Avenue, Los Angeles, CA 90028.

TEST CLIPS, model *TC-48* and model *TC-64*, are designed for troubleshooting very large scale integration (VLSI) IC's. They are manufactured with nail-head pins that keep probe hooks from slipping off ends, or with long, headless, test lead pins for connection to AP jumper cable assemblies. They are constructed of thermoplastic molded around contact pins, and feature a long-lasting steel pin and hinge design.

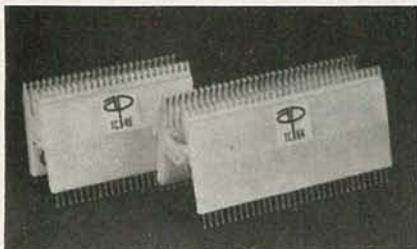

CIRCLE 113 ON FREE INFORMATION CARD

The model *TC-48* fits IC's with .5 to .6-inch row-to-row spacing and is priced at \$25.00. The model *TC-64* fits IC's with .9-inch spacing and costs \$32.00.—**AP Products Incorporated**, 9450 Pineneedle Drive, PO Box 603, Mentor, OH 44060.

DMM, model *DM25*, is a 3½-digit digital multimeter with a basic DC accuracy of ±0.2% of full scale. It will measure DC volts from 0.1 volt to 1000-volts; DC current from 0.1 mA to



CIRCLE 114 ON FREE INFORMATION CARD

200 mA; AC volts from 1 volt to 600 volts, and resistance from 1 ohm to 2 megohms.

Features include overload protection on all ranges, fuse-protected current and resistance ranges (to protect against excessive overload), automatic zeroing and polarity, and over-range and low-battery indication. An automatic limiter circuit will allow up to 140-volts AC to be applied on all ohms

ranges without blowing the fuse.

The model *DM25* measures 5.4 × 3.4 × 1.4 inches, weighs 10.5 ounces, and has an 0.4-inch display. It is powered by a standard 9-volt battery (included). Also included are safety-type test leads, carrying case, and instructions. Both the battery and the fuse are located in an easy-access compartment; there are no screws to remove.

The model *DM25* is priced at \$69.25.—**Universal Enterprises, Inc.**, 14270 N.W. Science Park Drive, Portland, OR 97229.

POWER SUPPLY, model *PEC SMPS 65W*, is designed for computers and computer peripherals and can have 3 to 4 outputs, under-voltage protection, a maximum ripple/noise factor of 2% peak-to-peak, user-selectable input voltage, and 80% efficiency typical at maximum power at nominal line voltage. Choice of packaging can include PC board, open frame, or enclosed unit.

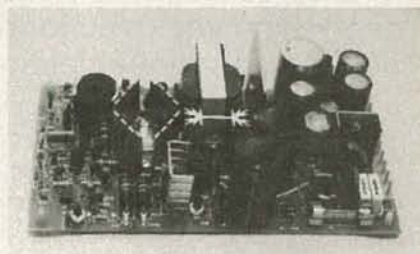

CIRCLE 115 ON FREE INFORMATION CARD

The model *PEC SMPS 65-W* is priced at \$99.00.—**Power Electronics Corp.**, 96 Milton Road, PO Box 2208, Rochester, NH 03867. R-E



We've added 47 pages and 250 new devices to the 1983 SK Guide.

This book carries more weight than any other solid state publication. It is backed by one of the biggest names in replacement devices. RCA. We have been deeply involved in the design, manufacture and testing of solid state devices for decades. When RCA introduces new types, you can trust them to perform reliably.

This year, the RCA SK Replacement Guide is 512 pages strong. With over 2100 SK and KH types available to replace over 170,000 industry types, and a convenient dual numbering system.

Why trust your solid state business to a source that is not involved in solid state manufacturing? Pick up your copy of RCA's hardworking 1983 SK Replacement Guide (SKG202B). See your RCA SK Distributor, or send \$2.50, in check or money order, to RCA Distributor and Special Products Division, P.O. Box 597, Woodbury, NJ 08096.

RCA SK Replacement
Solid State

The more logical way to look inside an IC.

LTC Logical Analysis Test Kits: everything you need for over 90% of your digital testing.

Everything you need is at your fingertips. Circuit-powered. And easy to use. Ready to read logic activity at a glance, point-by-point or IC by IC. Or to inject digital signals for testing.

Let the LEDs of our Probes, Pulsers and Logic Monitors light the way to answers for your troubleshooting, design and educational needs. The Logical Analysis Test Kit comes in two versions: our \$270.00* High-Speed Kit, LTC-2, which captures pulses as narrow as 6 nsec, rep rates to 60 MHz; and our \$240.00* Standard Kit, LTC-1, which goes to 50 nsec, 10 MHz. Both include complete manuals, accessories and a compact, custom-molded case. Either way, you've got a strong case for simplified digital testing.

Smarter tools for testing and design.

Our 23-oz. Logical Analysis Test Kits include Logic Probe, Digital Pulser, Logic Monitor, complete manuals and accessories, plus case.



GLOBAL SPECIALTIES CORPORATION

70 Fulton Terr., New Haven, CT 06509 (203) 624-3103, TWX 710-465-1227
OTHER OFFICES: San Francisco (415) 648-0611, TWX 910-372-7992
Europe: Phone Saffron-Walden 0799-21682, TLX 817477
Canada: Len Finkler Ltd., Downsview, Ontario

Call toll-free for details **1-800-243-6077**

*Suggested U.S. resale. Available at selected local distributors. Prices, specifications subject to change without notice.

© Copyright 1980 Global Specialties Corporation.

CIRCLE 11 ON FREE INFORMATION CARD

INSIDE A



757-767 COCKPIT

Microcomputers can fly the Boeing 757/767 airliners from takeoff to landing. Here, we will look at the major subsystems of the Flight Management System and the controls and displays that interface the pilots to the system.

Part 2 WHO WOULD HAVE BELIEVED TEN YEARS AGO THAT IT would one day be possible for an airline flight crew to say in effect, "Look Ma No Hands!!?"

At that time, just to think that a computer could fly an airliner was the realm of science fiction. But, today it's true with the introduction of the sophisticated Boeing 757/767. Why was it done? The reasons are quite obvious. The skies today are more crowded than ever and the cost of fuel is exorbitant. Computers are needed to assist the captain and flight crew in planning not only the safest, but also the most economical route.

Using state-of-the-art microcomputers, the flight crew can fly this airliner from takeoff to landing without using the controls for other than minor corrections. The real "pilot" is the microcomputer-based Flight Management System (FMS), the result of more than 10 years of research.

What can this system do? It can determine correct control surface and engine-thrust settings for any given condition. Further, because of the interactive nature of the system, the flight crew can change the flight configuration, if necessary, with a few button pushes, and the system will then respond by flying the new parameters.

As you can see, with this system the flight crew is freed of many of the arduous tasks it had to perform by hand. This fact was indicated by Henry McGlynn, manager of propulsion control systems engineering for General Electric's Aerospace Control Systems Department in Binghamton, N.Y. His department developed the 757/767 Thrust Management Computer (TMC), one part of the FMS.

The system, as a whole, "takes a load off the pilots' shoulders. Before (the development of the TMC), the pilots carried tables and charts and the work was manually done and complex," he noted. Now with a few button pushes, the same job is done. This is just one example of how the pilots are freed from routine tasks. It enables them to devote more of their time to managing the aircraft.

Flight management system

The FMS is actually more than just one microcomputer. In reality, it is made up of four major microcomputer-driven subsystems and the Flight Management Computer, the overall commander. The four major subsystems consist of the Flight Control System, the Inertial Reference System, the Emergency Indication and Crew Alerting System, and the Flight Symbol Generation System. (An overall block diagram of the system was presented last month.) The subsystems communicate with one another via a serial communications bus, operating at 12.5 and 100 kHz, which meets ARINC Standard 429.

Using bit-slice technology, the data stream is 32 bits wide. Instructions to and from components of the system are transmitted in 19-bit words, with the rest of the bit package reserved for data and machine address. This type of architecture is confirmed by the fact that the manufacturers of the major subsystems use bit-slice technology, applying 16-bit microprocessors to the task. When two 16-bit microprocessors are used in parallel, they can address a 32-bit data stream. However, the actual structure of the system, since the command microprocessors are 16-bit devices, is 16 bits. Only the communications are handled with a 32-bit path. Each major subsystem also communicates with members of its immediate grouping via the same bus.

According to a Boeing spokesman, system architecture is based on a consensus concept. If all subsystems involved in a task agree, then the task is performed. Further, because of the loose

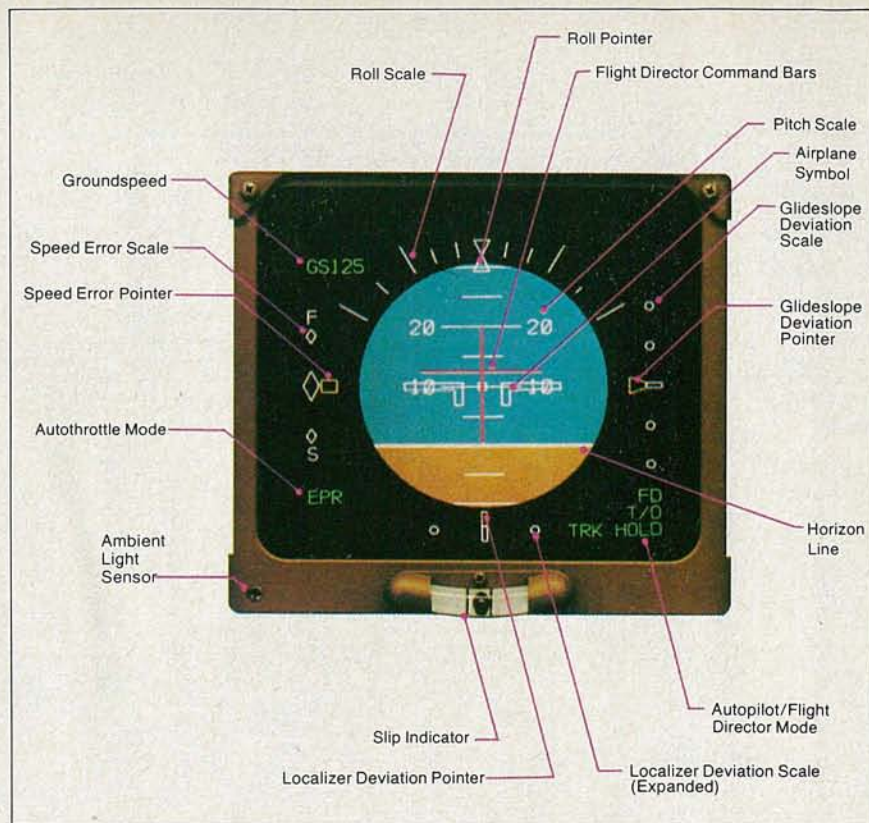

THE ADI (ATTITUDE DIRECTION INDICATOR). Flight Director Command Bars, generated by the Flight Control Computer, provide the pilot with steering guidance.

nature of the system, if one component fails, the other subsystems can continue operating. Called fail-soft, this allows safe airliner operation in the event of a major failure.

What all this means is that those systems interact and provide total flight management. It differs markedly from common practice on noncomputerized airliners. Let's look at the key differences between current airliners and the 757/767.

In other aircraft, the captain and first officer must generate their own information using charts, tables, and calculators. This requires a great deal of mental work and detracts from airplane management.

In the 757/767, the information is available to the flight crew at the push of a button. It appears on one of the flight deck's five CRT displays.

For instance, if the captain wants to change a parameter in the flight plan he has entered into the FMS, then entering the data via a keyboard and punching the EXECUTE button displays these new parameters on the Control/Display Unit (CDU). That unit is the key interface between the Flight Management Computer (FMC) and the flight crew. (See Fig. 1.)

Essentially, the CDU is a system terminal. It consists of a green-on-black display and an alphanumeric keyboard,

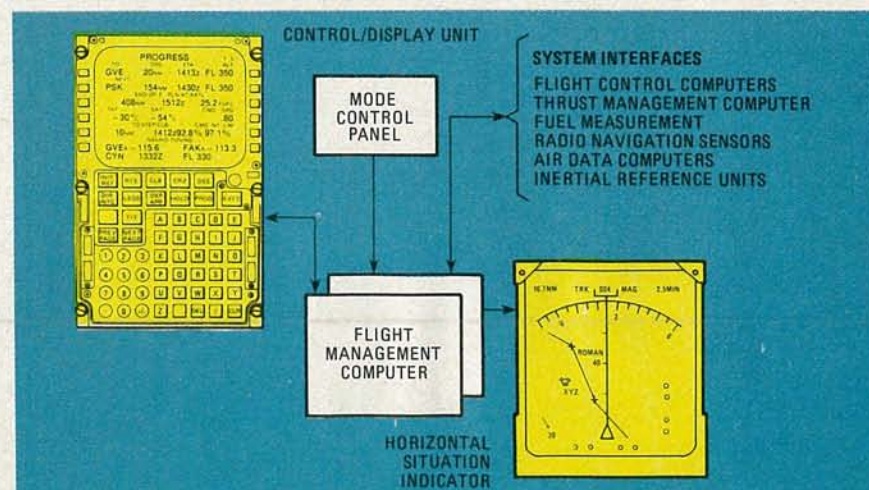
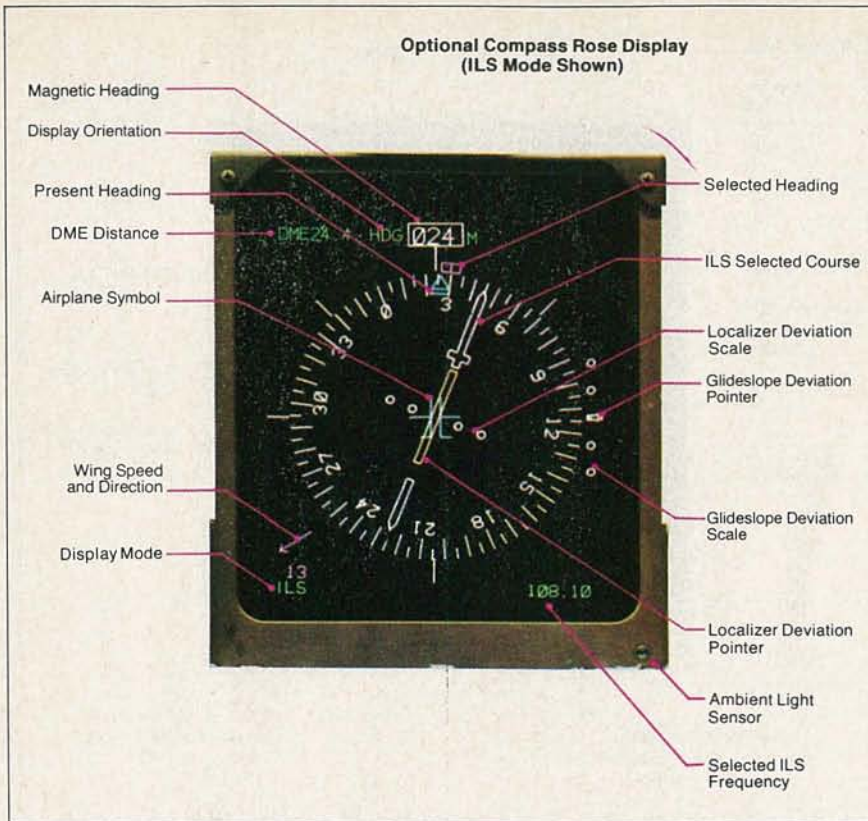

FIG. 1—THE FLIGHT MANAGEMENT COMPUTER lets the crew concentrate on overall airplane management. It executes all phases of the flight in the most economical way.



THE HSI (HORIZONTAL SITUATION INDICATOR). Here it is shown in the Instrument Landing System mode with the optional compass display.

which also includes 14 special function keys. Instead of using a traditional typewriter-type of keyboard, Boeing opted for one which is alphabet-oriented. (See Fig. 2.)

The special function keys allow one-key access to important information. For instance, if the captain would like to check on the progress of the flight, all he has to do is punch the RTE key on the CDU

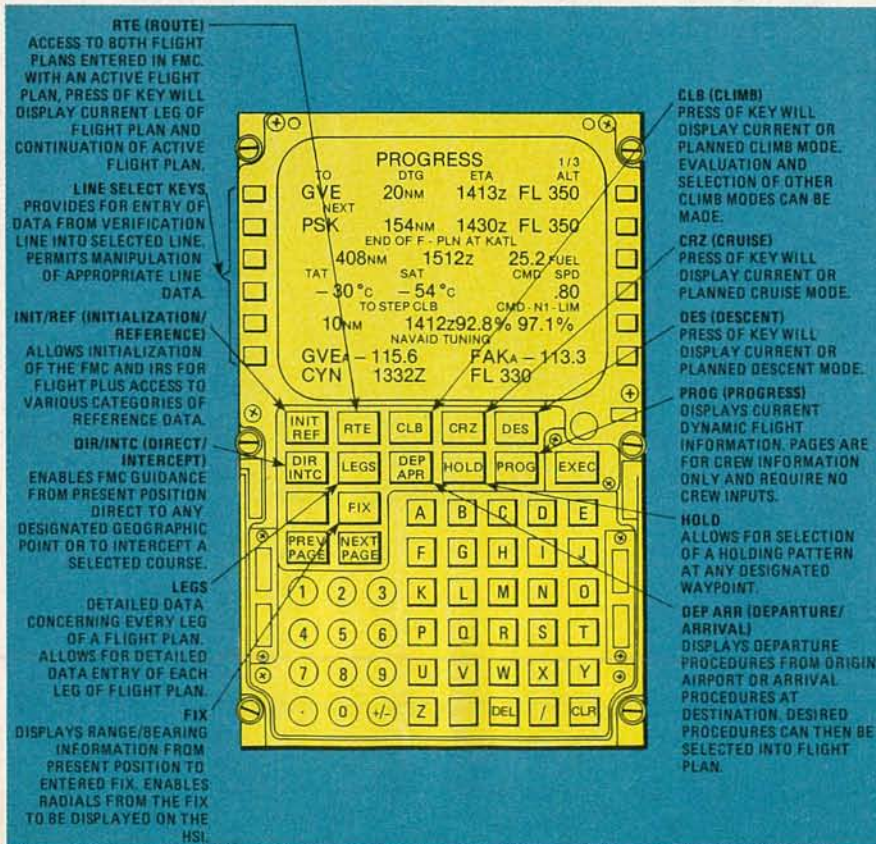

FIG. 2—THE CONTROL DISPLAY UNIT (CDU) gives the pilot complete control of the Flight Management Computer System.

console located below and to the right of the command seat. This key gives instant access to either of two flight plans entered in the FMC. Using the active flight plan, a press of the key displays the current leg of the flight plan and then reads out its continuation.

The CLB or climb key enables the flight crew to display the current or any planned climb mode. Further, this key also allows the crew to take a look at other climb modes and allows their evaluation. The same is true of the pre-programmed CRZ key, which displays current or any planned cruise mode.

With a touch of the PROG key, the flight crew can monitor current dynamic flight information. This key allows an information readout only. It is presented in page or screen format.

Not only does the CDU provide this information, but as the airliner approaches an airport, it allows the crew to look at arrival procedures with a press of the DEP ARR button. These procedures can be integrated into the overall flight plan. And, as you can see, it also helps to facilitate flight management as the plane readies for landing because the crew no longer has to pore over lists of landing procedures as the airliners approaches the airport. In fact, FMS will handle the landing if the crew opts for that function.

If, however, the airliner is stacked up and put into a holding pattern anywhere during a flight, a push of the HOLD button allows the crew to choose a holding pattern, whether halfway to destination or waiting for landing.

But, even before a landing can take place, there's still the takeoff to deal with and the INIT/REF (initialization/reference) button on the CDU allows the flight crew to initialize both the FMC and the Inertial Reference System. This button also allows the flight crew to access various categories of reference data. It also begins the crew's part of the information process. At that time, the crew enters all the parameters the FMS will use during the flight.

Once the FMC is initialized and the airliner is in the air, the DIR/INTX button enables the crew to use FMC guidance from a current position to any designated geographic point or to intercept a selected course.

Meanwhile, the LEGS button gives detailed information on every leg of a flight plan. Further, this function allows detailed data entry of each leg.

If, during this time the captain or first officer would like information concerning the range and bearing to a particular entered position, one of them can press the FIX key. This function brings up a display of the information and further will cause radials from the fix to be displayed on the Horizontal Situation Indicator (HSI), another of the system's CRT's and the visual roadmap for the flight crew.

While all of this information is neces-

sary for the captain and flight crew, it really wouldn't be much use if they weren't able to manipulate it. That function is handled by six line-select keys on the CDU. In the non-aircraft microcomputer world, information entry and retrieval functions are all pretty much standard fare. Most systems depend on some sort of keyboard for input and most use some sort of command address language. Programmers may use BASIC, COBOL, FORTRAN, or many other languages, while those people using word processing use English. However, the FMC language is unique, but one with which the captain and first officer are quite familiar—Air Traffic Control terminology.

This type of interface puts the FMS and flight crew on familiar terms and it eases the transition to a computerized airliner.

Lying below this human interface mechanism is the FMC itself. It is the master link in the FMS. This microcomputer is able to receive inputs from all the subsystems and is then able to compute its decision. It also commands the subsystems to perform their tasks.

Developed by the Sperry Flight Systems Division of Sperry Rand, headquartered in Phoenix, Ariz., the FMC is driven by a 16-bit processor.

The FMC houses preprogrammed navigation and flight planning information. The program is updated every 28 days and is contained on a 4 megabyte disk. Other information resides in PROM (Programmed Read-Only Memory). This system also has up to 64K of RAM (Random Access Memory), which is a necessity because of the interaction between the FMC and the pilots.

The system receives inputs from other subsystems and determines how best to fly a course. This function is, in turn, determined by a set of cost index parameters that are biased toward time and fuel factors, according to Larry Bowe, head of the engineering department at Sperry Flight Systems.

The FMC interfaces directly with the flight control system and the autopilot and it receives positional inputs from both. It then generates a map display on the Horizontal Situation Indicator (HSI) CRT. It also receives inputs from the VHF Omnidirectional Range (VOR) finder and from the Distance Measuring Equipment (DME), which are also used in its computations. When all of the information is digested and weighed by the FMC, it generates the flight readout, which is displayed on the CDU.

As one would expect in a system as critical as this one, there's redundancy for safety. Rather than relying on one FMC for both the captain's and first officer's CDU's, Boeing and Sperry designed the system so each unit is driven by a separate microcomputer. In this way, should one of these units fail, the other can be used to fly the aircraft.

Reliability is also a feature of this unit.

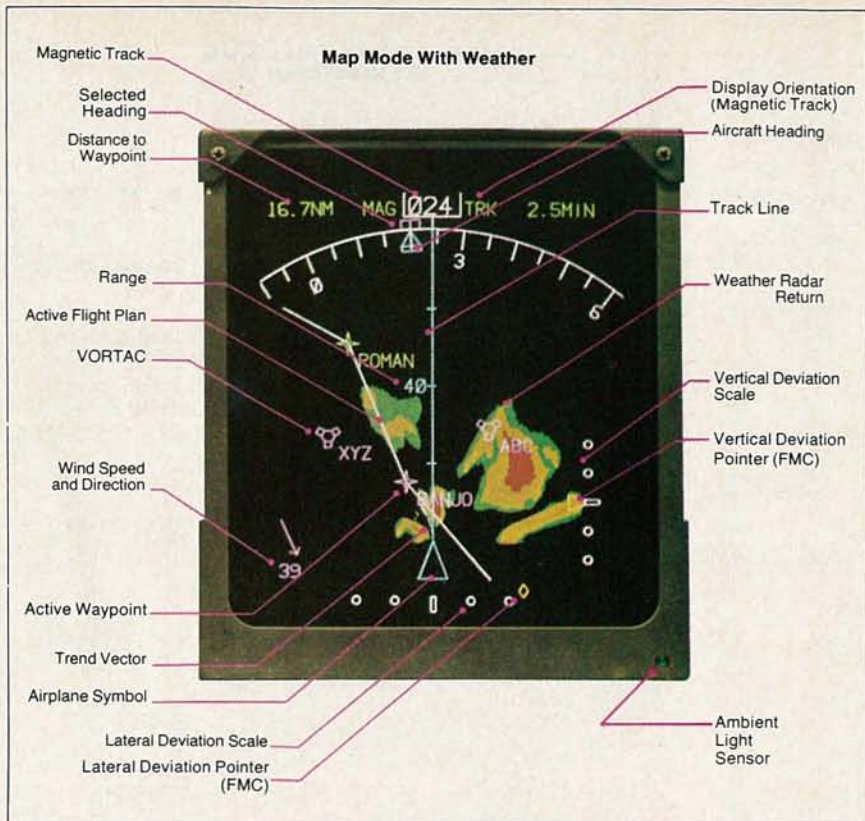

IN ITS MAP MODE, the Horizontal Situation Indicator shows the desired flight path and navigation features.

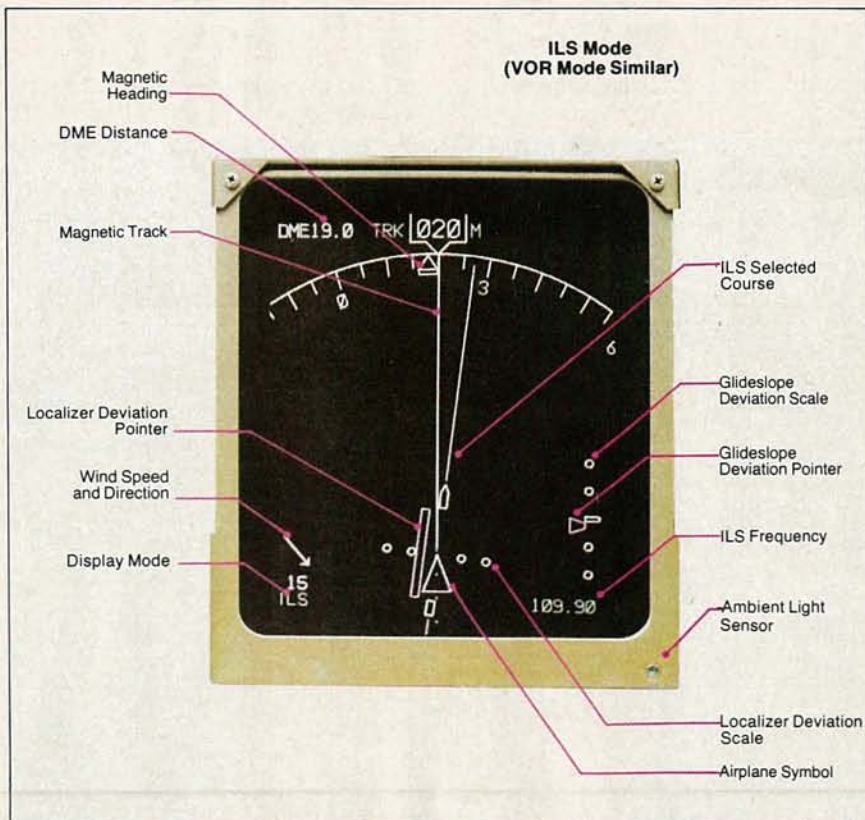

THE HORIZONTAL SITUATION INDICATOR shows the airliner's relation to the selected ILS course.

Bowe estimated the mean time between failures is 6,000 hours and since an airliner operates about 3,000 hours per year, the average time between failures will be

on the order of two years.

As important as the CDU is for interfacing the Flight Management System and the flight crew, there's another key

interface at the top of the pilots' glareshield, the Mode Control Panel. (See Fig. 3.) This system not only interfaces with the Flight Management Computer, but also the TMC and the Flight Control Computer (FCC) and the Inertial Reference System. The Inertial Reference System is shown in Fig. 4.

It is with this panel that the flight crew inputs such parameters as air speed, rate of climb and ultimate altitude. This panel provides a central area for all autopilot control selections and modes. Those functions include the autopilot, autothrottle and flight director. It is from this panel that the flight crew also has access to a backup landing option in the event of a major system failure.

The Mode Control Panel also initiates automatic tracking of the Flight Management Computer's flight plan in either the lateral or vertical planes.

Thrust management computer

Another panel, beneath the Mode Control Panel—the Thrust Mode Select Panel—also interfaces with TMC.

Mounted in two line replaceable units,

the TMC is responsible for determining and setting correct engine parameters after the flight crew makes its determinations of such variables as speed, altitude, heading, climb rate and whether the airliner is in a takeoff or cruise mode. These figures are entered through the Mode Control Panel. The TMC also looks at other variables and reports to the FMC and Engine Indication and Crew Alerting System (EICAS), which displays engine information on a color CRT.

Further, the TMC also acknowledges the crew's engine operational choices entered via the Thrust Mode Control Panel. This unit gives the pilot the ability to derate the engines from the TMC settings for better fuel economy. It further allows him to override the system for emergency power.

Proper thrust control is of primary importance to the air lines, explains McGlynn. If an airliner's engines run too hot it wears them out much more quickly than if the settings were cooler. Also, in this condition the engines use more fuel.

So, the primary function of this system is to limit engine thrust according to the

aircraft's flight condition, height and temperature. This system also functions to bleed off engine power for such functions as cabin air conditioning and deicing.

TMC also aids in an important display function. Since it is involved with vertical navigation and flight level changes, its inputs, along with those from those of the Mode Control Panel, help drive the Attitude Direction Indicator (ADI). This instrument tells the flight crew whether the airliner is in level flight, climbing, descending or banking. This indicator is familiar to many fliers as the floating ball airplane whose wings have to be kept level with the artificial horizon.

Driven by a 16-bit General Electric MCP-701A 16-bit fixed point processor, the TMC is an accumulator-based system designed specifically for avionics control products. When it was first designed, this system relied on medium-scale integration and bit-sliced system architecture to achieve the same goal the one-board system now handles. However, the 701A allows GE to keep the system unit to one motherboard.

The microcoded instruction set emulates the one that is found in one of the nation's most sophisticated fighters, the F-18. Programmed in machine language, much of the memory is Read-Only Memory (ROM)-based. However, there is a small scratchpad area of Random Access Memory for storage of current flight information.

Via its transmitters and receivers, this system interfaces with the Air Data Computer, which computes air speed, wind speed and delivers these inputs to the system; the Thrust Mode Select Panel; the Flight Management Computer, and the throttles. Performance management functions are performed in concert with the FMC and the autopilot/flight director system.

The Mode Control Panel, also driven by a microprocessor, also interfaces with another of the major microcomputer subsystems of the FMS, the Flight Control Computer (FCC).

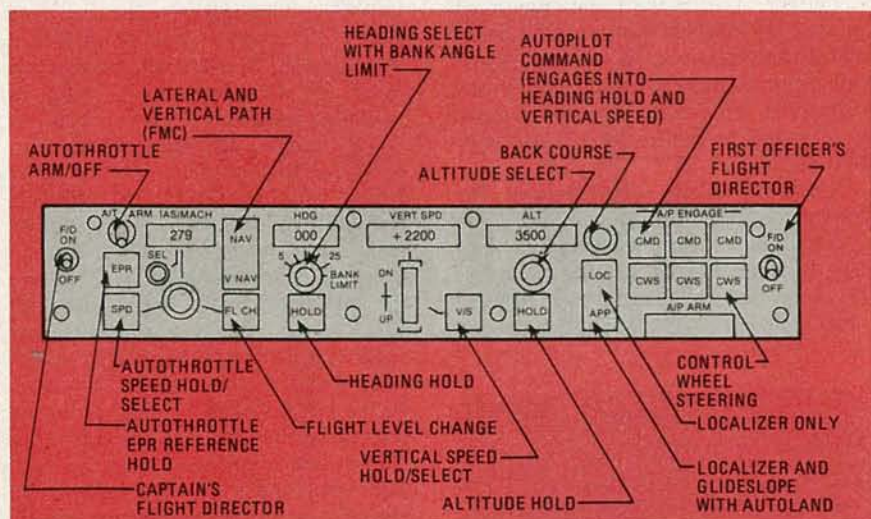

FIG. 3—THE MODE CONTROL PANEL is the centralized location for all autopilot-control selections and modes.

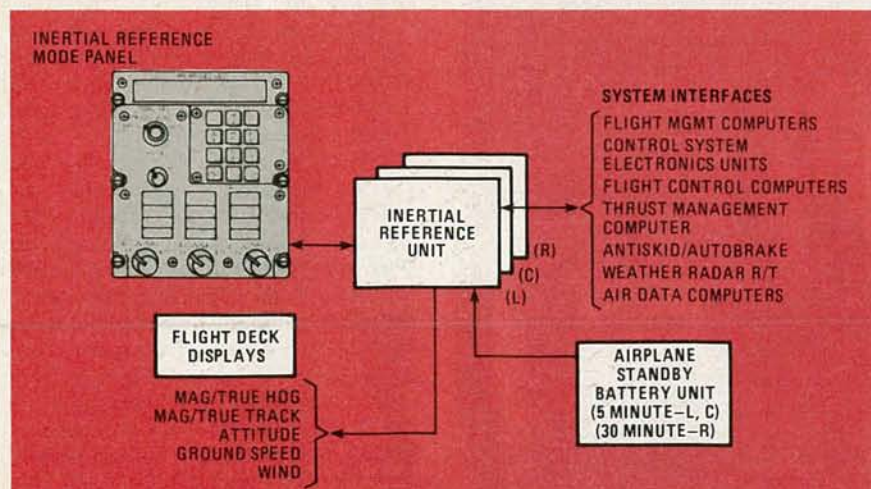

FIG. 4—THE INERTIAL REFERENCE SYSTEM uses Ring Laser Gyros. It can align its reference axes to true north by analyzing the spin vector generated by the earth's rotation.

Flight control computer

Its primary functions are controlling vertical speed, providing takeoff assistance and integrated autopilot and autothrottle speed control, autoland and autorollout control, and heading and altitude control.

In reality, the Flight Control Computer acts on the airliner's control surfaces. After receiving the inputs from the Flight Management Computer, inertial reference units, Air Data Computers, radio altimeters, instrument landing receivers, air-ground logic unit and the airspeed indicators, it sets those surfaces—elevators, ailerons and rudder—for each flight condition. (See Fig. 5.) If, for instance, the Flight Management System is programmed to climb at a certain point,

the FCC will respond with settings for the climb.

Responsible for developing the FCC was Rockwell International's Collins Air Transport Division in Cedar Rapids, Iowa. This division also developed the circuitry for the highly advanced Electronic Flight Instrument System (EFIS), EICAS, the ADI and HSI displays. Those systems provide the key visual and warning indications for the entire Flight Management System.

Access to the various EFIS controls is obtained through the EFIS control panel. As with other system control panels on this aircraft, there are separate panels for the pilot and first officer.

The upper section of the panel controls the ADI and allows the pilot to enter his decision height prior to making an approach. This number is automatically displayed on the ADI during the approach and automatically shifts to a DH display when this height is reached. The lower section controls the HSI and allows the pilot to select a display mode.

If MAP or PLAN are chosen, then the display will be scaled according to the maximum range chosen by the RANGE knob. The MAP mode displays the map oriented along the current track of the airliner, while PLAN displays a north-up orientation. Buttons on either panel control access to supplementary navigation information. This information is then displayed on the color CRT's in front of the flight crew.

Those color displays are very sophisticated instruments themselves. Using 16-bit 8085 microprocessors, the CRT's are capable of high-level graphics. For instance, the ADI combines both CRT and

electromechanical functions to present the flight crew with a picture of the airliner's attitude. The traditional ball-type of ADI indicator is combined with a surrounding CRT for quick information updates.

Further, the CRT displays the ground-speed, autothrottle mode, autopilot-flight director mode, glideslope deviation and localizer deviation scale. It is quite an advance over traditional ball-only mechanisms and centralizes these functions on one screen, instead of in several places on the instrument panel. As one can easily see, this eases the work of the flight crew.

Other displays

A color CRT, the HSI presents the crew with a look at the horizontal position of the aircraft in relation to the flight plan. Further, it displays a map of navigation features and aircraft track. This map also shows where the airliner will be turning and the desired flight path. Also, it indicates where the aircraft is in relation to a desired position.

This type of display allows rapid and accurate flight path correction and maneuvering by the pilots, if needed.

Further, it gives the flight crew other needed information such as wind speed and direction, lateral and vertical deviation from the selected flight profile and distance to a waypoint. This information is selectable as desired by the captain or first officer.

Since the HSI is programmable, the captain and first officer can adjust the composition of the display to suit their specific needs. Color weather radar displays may be selected and presented at the same scale and orientation as the map, as

well as navigation aid information and airport and ground reference symbols. There's even the option of displaying speed, altitude, and time of arrival for each flight path waypoint.

All of these functions are possible thanks to the programmability of the system. For instance, if the captain or first officer chooses the VOR or Instrument Landing System (ILS) mode on the EFIS panel, then the HSI shows the relationship of the airliner to a selected VOR or ILS course. This information is displayed in a similar format to current electromechanical devices. This last feature, alone, should help insure that even a newcomer to the system will feel comfortable with it. Again, weather radar displays can be overlaid on this display.

An optional compass display, which combines many of the features of the other displays, can also be chosen, if the airline operating the aircraft chooses to have it.

A similar type of Collins-developed system is used for the EICAS function of the FMS.

Set dead center in the instrument panel, EICAS monitors display not only engine parameters, but also give the crew warnings in the event of a problem with the aircraft. Urgent messages are displayed in red on the color CRT's, while less urgent messages are displayed in yellow. Aural warnings are also provided.

Access to this system is through the EICAS control panel, located directly below the pair of CRT's. An uncluttered panel, the pilot or first officer can have access to a full readout with the push of the ENGINE button. In normal operation, EICAS only displays primary engine readouts. When either flight officer pushes the STATUS select button, the lower EICAS display will show data relating to the status of the airplane including such information as hydraulic fluid levels and control surface positions. On the ground, these monitors will display maintenance information to technician. The flight crew has no control over this information.

Interestingly, this system was developed with an eye toward keeping costs down. If an HSI CRT should fail, it can be replaced with one of the EICAS monitors. Further, the entire EICAS system, which consists of two color CRT monitors, two EICAS computers, supplementary caution and warning annunciator and a standby liquid crystal engine indication display, consists of only six line-replaceable units. These are units which can be easily replaced by maintenance technicians right on the flight line. That contrasts with more than 40 in other standard airliners.

Even with all this computerization, you can again see the level of safety backup. If EICAS system should fail completely, then the LCD provides the flight crew with the information it needs to continue flying the aircraft.

R-E

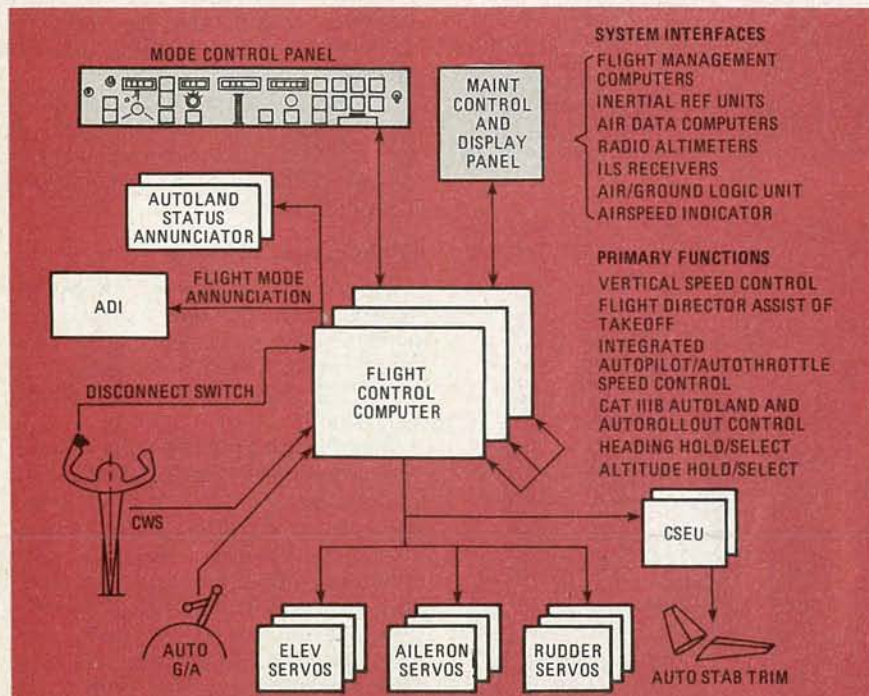
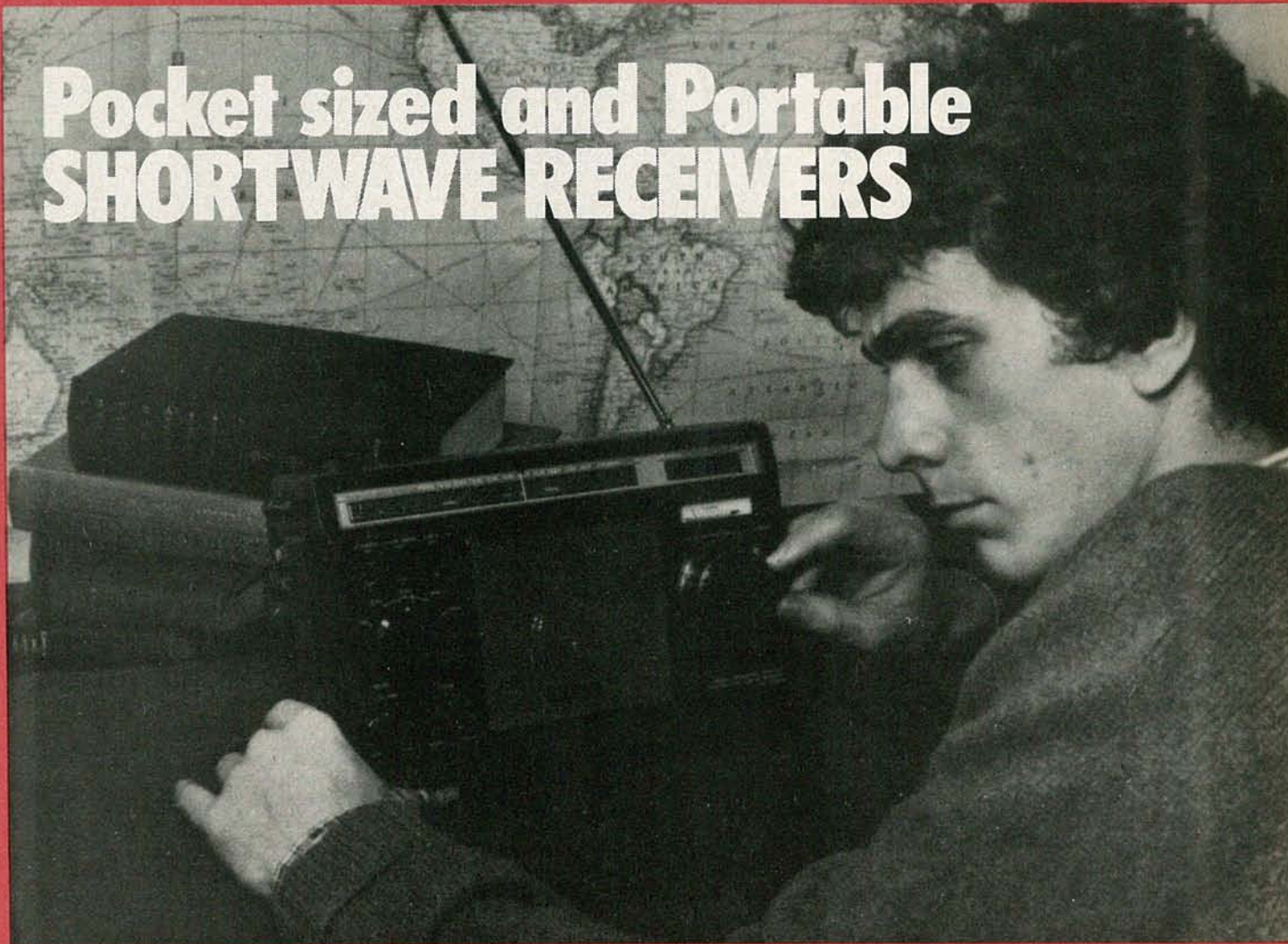

FIG. 5—THE FCC (FLIGHT CONTROL COMPUTER) receives inputs from many systems, including the Flight Management System, The Thrust Management Computer and the Inertial Reference system.

Pocket sized and Portable SHORTWAVE RECEIVERS



IT WASN'T MANY YEARS AGO THAT shortwave listening was a hobby enjoyed only by technically capable individuals who had tabletops full of complicated receiving equipment. But that has changed dramatically over the past year or two as advanced semiconductor technology has found many applications in portable communications receivers, making them as easy to use as your TV set.

Today, affordable portable shortwave radios offer features previously available only on professional-quality equipment costing many thousands of dollars more. And some of the newest portables use integrated circuits and miniature components, allowing the sensitive electronics to be housed in cases that are small enough to fit in your pocket.

The shortwave spectrum

By international agreement, users of the high-frequency (shortwave) spectrum (3.0-30.0 MHz) confine broadcasts intended for general listeners to several segments of the spectrum, called bands. Each band is identified by both its frequency and its wavelength (in meters) as

The newest generation of portable shortwave receivers offers features and performance previously found only on top-of-the-line table models. Here's a look at what's available, and what these small powerhouses can do.

DANNY GOODMAN

shown in Table 1. Thus, the shortwave broadcast band that begins at 9.5 MHz is also called the 31-meter band, while the band of frequencies that begin at 17.8 MHz is called the 16-meter band (see Table 1). You'll note, of course, that as the frequency increases, the wavelength decreases.

The thing that makes shortwave listening so fascinating, however, is that under certain conditions a transmitted signal

can be heard halfway around the world. That's because signals with frequencies below 30 MHz are reflected by the ionosphere. That phenomenon makes long-distance shortwave listening possible.

Because the ionosphere is strongly affected by the sun, the nature of that reflection—and hence, how far away the signal can be received—depends mainly upon the time of day and time of year. What that means is that not all frequencies are useful for broadcasting at all times. What's more, various factors can make conditions unstable even on a day-to-day basis. Radiation from the sun (more accurately, from sunspots) changes daily (and, on a larger scale, over an approximately 11-year cycle), adding uncertainty as to how well a signal will be received in a particular area. Signals may be strong on one frequency today, suffer from periodic fading tomorrow, and occasionally be almost inaudible. The last occurs especially during sudden ionospheric disturbances.

Broadcasters study radio-wave propagation carefully to help plan the times and frequencies for their broadcasts.

Equipped with predictions from propagation scientists, station planners may choose several frequencies in more than one band to make sure that a target area is adequately served during the season, no matter what the daily propagation variances may be. Then, even if they have correctly predicted the proper bands, they must hope that other broadcasters choose frequencies in those bands so that neither one interferes with the other. That is a far cry from the fixed-frequency allocations of our own AM and FM broadcast bands, which are strictly regulated by the Federal Communications Commission.

Tuning in

To help SWL's keep track of broadcaster's schedules, the *World Radio TV Handbook* (WRTH) is like an annual *TV Guide* updated three times a year by a subscription newsletter. The WRTH is the most comprehensive listing of radio and television stations from practically every country in the world. Included with each listing is the mailing address for each of the stations, many of whom have detailed schedules available on request.

Once you know the time and frequency of a program you'd like to hear, you'll need to tune your receiver precisely to that frequency. However, on many multi-band radios with shortwave capability, the shortwave spectrum may be divided into only two or three sections. The tuning rates—how big a chunk of the spectrum is covered with a single revolution of the tuning dial—of those receivers are inadequate for the number of stations you can tune in one revolution of the dial.

Consider, for example, that the entire AM broadcast band (0.550-1.600 MHz) is slightly more than one megahertz wide, and takes up the entire width of the tuning dial. That makes for comfortable tuning, given the local station spacing of 30 kHz or more. But a tuning range marked SW1 on a portable radio may use the same tuning dial space to cram nine megahertz;

**TABLE 1—
BROADCASTING BANDS**

| Meter Band | Megahertz |
|------------|-----------------|
| 120 | 2.30 — 2.50 |
| 90 | 3.20 — 3.40 |
| 60 | 4.75 — 5.06 |
| 49 | 5.95 — 6.20 |
| 41 | 7.10 — 7.30 |
| 31 | 9.50 — 9.78* |
| 25 | 11.70 — 11.98* |
| 19 | 15.10 — 15.45* |
| 16 | 17.70 — 17.90* |
| 13 | 21.45 — 21.75* |
| 11 | 25.60 — 26.10** |

*This band will be expanded in the late 1980's or early 1990's.

**This band will be decreased in the late 1980's or early 1990's.

TABLE 2—PORTABLE SHORTWAVE RECEIVERS

| Type | Brand/Model No. | Price | LW | AM | FM | SW Coverage (MHz) |
|---------------------------|-------------------------|---------------|-------|----|----------|-------------------|
| Pocket-sized | Panasonic RF-085 | \$ 89.95 | N | Y | Y | 2.3 — 18 |
| | | Sony ICR-4800 | 89.95 | N | Y | N |
| | | | N | N | N | 9.45 — 9.85 |
| | | | N | N | N | 11.70 — 12.00 |
| | | | N | N | N | 15.10 — 15.50 |
| | | | N | N | N | 17.60 — 18.00 |
| | Sony ICF-7600A | 159.95 | N | Y | Y | 5.95 — 6.20 |
| | | | N | N | N | 7.10 — 7.30 |
| | | | N | N | N | 9.50 — 9.80 |
| | | | N | N | N | 11.70 — 12.00 |
| | | | N | N | N | 15.10 — 15.45 |
| | | | N | N | N | 17.70 — 17.90 |
| | | | N | N | N | 21.45 — 21.75 |
| Digital readout | General Electric 7-2990 | 235.00 | N | Y | Y | 2.3 — 31 |
| | Magnavox AL999 | 299.95 | Y | Y | Y | 1.6 — 26.2 |
| | Panasonic RF-2600 | 239.95 | N | Y | Y | 3.9 — 28 |
| | RF-2900 | 299.95 | N | Y | Y | 3.2 — 30 |
| | RF-3100 | 319.95 | N | Y | Y | 1.6 — 30 |
| | Sony ICF-6500W | 199.95 | N | Y | Y | 3.9 — 28 |
| | ICF-6800W | 699.95 | N | Y | Y | 1.6 — 30 |
| | CRF-1 | 1,795.00 | Y | Y | N | 1.6 — 30 |
| CRF-330K | 2,495.00 | Y | Y | Y | 1.6 — 30 | |
| Microprocessor-controlled | Magnavox D2924 | 179.95 | Y | Y | Y | 5.95 — 15.45 |
| | Panasonic RF-799 | 249.95 | Y | Y | Y | 2.3 — 26.135 |
| | RF-6300 | 749.95 | Y | Y | Y | 1.6 — 30 |
| | RF-9000 | 3,800.00 | Y | Y | Y | 1.6 — 30 |
| | Sony ICF-2001 | 349.95 | Y | Y | Y | 1.6 — 30 |

3-12 MHz is a common range and it includes four complete shortwave broadcast bands, where crowded nighttime conditions will often find stations within 5 kHz of each other. Just tuning from station to station requires surgeon-steady hands for turning the dial just a small fraction of a degree. And trying to find 11.750 MHz accurately with a tuning dial on which the pointer covers a third of the band is practically impossible.

Another drawback to those types of

receivers is that they are not necessarily optimized for shortwave reception and are, therefore, not particularly sensitive to stations other than the powerhouses. Nor are their circuits selective enough to eliminate interference from strong stations on frequencies close to that of the desired station. Many of them also are unable to tune above 16 MHz, cutting listeners off from two daytime shortwave bands, 16 and 13 meters.

Today, however, you can buy portable shortwave radios that overcome most of those deficiencies, making shortwave listening more enjoyable for the casual listener. Less time is spent twiddling with the radio, and more time is spent listening to the program.

Today's receivers fall roughly into



The Magnavox model AL999.



G-E model 7-2990 six-band portable.

| Size (inches) | Wght. | BFO | Wide/Narrow Filters | Dual Conversion | Tuned RF Amplifier |
|--|-------------|-----|---------------------|-----------------|--------------------|
| 4 ⁷ / ₁₆ × 6 ¹⁵ / ₁₆ × 1 ¹ / ₄ | 17 oz | N | N | N | N |
| 2 ¹⁵ / ₁₆ × 5 ¹ / ₄ × 7 ¹ / ₈ | 8 oz | N | N | N | Y |
| | | | | | |
| 4 ⁵ / ₈ × 7 ¹ / ₈ × 1 ¹ / ₄ | 22 oz | N | N | Y | Y |
| | | | | | |
| 14 ⁵ / ₈ × 10 ³ / ₄ × 6 | 8 lbs | Y | Y | Y | Y |
| 13 × 9 × 4 ¹ / ₄ | 8 lbs | Y | Y | Y | Y |
| 9 ⁹ / ₁₆ × 13 ¹ / ₂ × 4 ⁹ / ₁₆ | 7lbs, 4oz | Y | Y | Y | Y |
| 9 ¹ / ₁₆ × 15 × 4 ³ / ₄ | 8lbs, 10oz | Y | Y | Y | Y |
| 4 ³ / ₄ × 14 ⁹ / ₁₆ × 9 ¹ / ₂ | 7lbs, 1oz | Y | Y | Y | Y |
| 6 ¹ / ₂ × 11 ³ / ₈ × 4 | 4lbs, 1oz | Y | N | Y | N |
| 7 ¹ / ₄ × 17 ¹ / ₈ × 9 | 13 lbs | Y | Y | Y | Y |
| 10 ¹ / ₄ × 4 × 13 ¹ / ₈ | 14lbs, 9oz | Y | Y | Y | Y |
| 13 ¹ / ₂ × 17 ³ / ₄ × 8 ¹ / ₈ | 33lbs, 15oz | Y | N | Y | Y |
| | | | | | |
| 9 ¹ / ₄ × 6 × 2 ¹ / ₄ | 5 lbs | N | N | N | Y |
| 6 ⁹ / ₁₆ × 10 ¹ / ₁₆ × 2 ⁵ / ₁₆ | 3lbs, 7oz | N | N | S | Y |
| 11 ⁷ / ₁₆ × 17 ¹ / ₈ × 5 ³ / ₁₆ | 11lbs, 7oz | N | N | Y* | Y |
| 20 ⁹ / ₁₆ × 14 ⁵ / ₃₂ × 8 ¹ / ₃₂ | 50lbs, 11oz | Y | Y | Y* | Y |
| 6 ³ / ₁₆ × 12 ¹³ / ₁₆ × 2 ³ / ₁₆ | 4lbs | Y | N | Y | Y |

*For most shortwave bands, single conversion for others.

three categories: sensitive pocket portables with analog (slide-rule) tuning; those with simple digital frequency readouts, and those with microprocessor-controlled phase-locked-loop (PLL) tuners. Table 2 lists some of the units currently available.

Shirt-pocket shortwave

Among the small shortwave portables, Sony's *ICF-7600A* is a good example of an easy-to-use receiver even though it features an analog, rather than digital, tuning-system.

The receiver covers the local AM and FM bands, plus seven shortwave bands from 49 to 13 meters in a most useful way: Each shortwave-broadcast band has its own tuning range. That spreads out the stations within a given band so that tuning is not so critical. Moreover, you are better

able to tune to a specific frequency with the help of dial markings spaced every 50 kHz.

The receiver covers the 49- through 11-meter bands. That coverage, plus a bit of tuning above and below those ranges, includes most of the English-language stations you'll want to hear. Some broadcasts, however, like Radio Peking's clear frequency of 15.52 MHz (one of several frequencies) and a growing number of stations above 12.0 MHz, are outside the internationally agreed bands, and the tuning range of the unit.

Miniaturization plays a big role in the circuit design of that small receiver. Each shortwave band has its own crystal oscillator for tuning stability. It uses dual-

conversion (two intermediate frequencies) superheterodyne circuitry on shortwave for good sensitivity and to help reduce unwanted images from interfering with the station you want to hear—a common problem in small portables. It also features a tuned RF amplifier to help insure that the best possible signal-to-noise ratio is obtained. There is even a ceramic filter to help limit interference from stations on adjacent frequencies, thus improving selectivity. While the performance of a radio its size—even with all its "big radio" features—won't measure up to table-model standards, that receiver holds its own rather well against many of the receivers listed in Table 2.

The *7600A*'s little brother, the Sony *ICR-4800* is one of the smallest portable shortwave receivers available, measuring 5¹/₄ × 2¹⁵/₁₆ × 7¹/₈ inches. It features Am broadcast and five shortwave bands: 49, 31, 25, 19, and 16 meters, the ones most popular with broadcasters. The tuning range of some bands is a little wider than that offered by the *ICF-7600A*, making it possible to pick up more of those broadcasters who are slightly "out of band."

What neither of those receivers can tune, however, is the standard time signal station, WWV, a service of the National Bureau of Standards in Ft. Collins, CO. Usually audible on 5, 10, 15, and 20 MHz, a voice announces the time (with atomic clock accuracy) on the minute, plus severe ocean-storm warnings and radio-propagation forecasts at appointed times during the hour. The paperback-book-sized *RF-085* from Panasonic does allow you to receive WWV as it provides continuous tuning from 2.3 to 18 MHz (120 to 16 meters) over three bands. But, although it is remarkably sensitive for its small size, a beginning SWL may find the cramped and inexact shortwave band tuning a bit frustrating at times.

With those small radios—all of them wonderful travel companions—you'll have adequate signal quality under most conditions with the built-in telescoping antennas. Reception can often be improved by placing the radio as close to a window as possible, or by adding an external antenna, as discussed later.

Digital readout

Another recent advance in portable-receiver technology is the addition of digital frequency-readouts to assist in tuning. The units offering that feature are anything but pocket sized, yet once you've experienced the convenience of such a readout, you won't want to return to the analog style unless you need to travel very light. With the digital display, there is no guessing whether you have the correct frequency. If you know that Swiss Radio International begins transmitting in English on 9.725 MHz at 0145 Greenwich Mean Time (8:45 pm EST), then



Panasonic's model *RF-085* five-band receiver.



The Sony nine-band *ICF-7600A*.

simply dial up 9.725 on the readout a few minutes before, and you'll be ready for the start of their broadcast. Digital-readout receivers are available with vacuum fluorescent displays (which consume a lot of battery power but can usually be turned off when not needed for tuning), or liquid crystal displays (LCD's). The latter require a backlight for viewing under low-light conditions.

General Electric's 7-2990 is a new receiver in this category. The GE receiver offers AM, FM, and four bands of shortwave tuning giving you continuous coverage from 2.3 to 31 MHz. That means you can hear all shortwave broadcast bands as well as amateur radio and commercial bands. Frequency can be read on either an analog- (slide-rule type) or vacuum-fluorescent digital-display. In that receiver, as in others in its class, the digital readout is provided by adding a frequency counter (with some modifications) to a standard analog shortwave receiver. An SW CALIBRATOR control on the front panel helps you align the receiver and the counter by tuning to a frequency standard like WWV.

The unit features dual conversion as well as a tuned RF amplifier. Another control you'll notice on that type of receiver is a WIDE/NARROW bandwidth switch. The intent of a narrow bandwidth is to reduce the amount of interfering signals on either side of the desired signal from reaching the speaker or headphones. Ideally, a narrow setting should keep out extraneous signals. But in practice, portable-receiver bandwidth filters are generally not as effective as those used in more expensive table radios. The wide setting may be fine for local AM stations with their healthy frequency spacing between stations, but is impractical for tightly spaced shortwave stations. Among today's portables, the Sony CRF-1 has the most effective narrow bandwidth, according to specifications, but its price is out of reach for many.

The Panasonic RF-3100 is one of a new generation of portable receivers. Adapting a technique used in expensive table-model communications receivers, the

unit features PLL frequency synthesis—a sign of a very stable tuning section. Even solid-state receivers can be unstable and drift off their original frequency, particularly during the first 10 minutes of operation. They may also suffer from mechanical instability—just lightly tapping the receiver case with a finger will make the unit change frequency. But a PLL synthesized tuner “locks” onto the desired frequency. Nowhere is that more appreciated than when tuning single sideband (SSB) amateur radio or commercial stations. Successfully tuning those stations requires that the receiver's beat frequency oscillator (BFO) be engaged and tuned to the signal's natural voice pitch. The slightest drifting will raise or lower the voice's pitch beyond intelligibility.

To tune, say, 15.260 MHz on the RF-3100, you first turn the rotary BAND switch to the 15-MHz band, and then tune the large tuning knob until the last three digits on the display read 260. The tuning range is divided into 29 one-megahertz bands, plus AM and FM. Sometimes, as when you're just tuning through the spectrum to see what you can pick up, that one-MHz stepping can be just a little inconvenient because, if you want to tune continuously, you must whirl the tuning knob back to the beginning of the band every time you increment from one range to the next.

The RF-3100, like many other portables its size, comes with a soft shoulder strap for the SWL on the go; it can be removed if the receiver stays mostly at home.

Computerized shortwave

The third type of portable receivers we will discuss takes the concept of PLL tuning a step farther. In those, microprocessors control the PLL circuit. The tuning knob, as we've known it, doesn't even exist. Instead, pushbutton keyboards let us “punch in” the frequency we want to hear. If we want to casually tune up or down the band looking for stations, we just push an appropriately marked button and the synthesizer will step up or down in frequency under mic-

roprocessor control until the button is released. The microprocessor can also store favorite frequencies in memories; those can be instantly recalled by just pressing a button.

The first affordable pushbutton shortwave was Sony's ICF-2001. More recently, Panasonic and Magnavox have added “smart” portables to their shortwave lines.

The Magnavox D2924, though offering only limited shortwave band coverage (49 through 19 meters), has a number of features useful for the shortwave neophyte and veteran as well. The radio has essentially four broad bands: longwave, AM, shortwave, and FM, each selected by pushbutton. In the shortwave mode, each press of the SW SELECTOR button puts the receiver at the lowest frequency in one of the five international broadcast bands. An indicator on the LCD display shows which band you're tuned to. From the bottom of each band, you can either tune up or down in steps with the corresponding manual tuning buttons, or have the receiver search the band for a strong signal. Pressing SEARCH silences the receiver's audio as the radio's frequency display shows where it's tuning. If a strong signal is detected, scanning stops on that frequency, and the audio is restored. If the station is not what you want to hear, press SEARCH again, and the tuner will quietly continue up the band. When it reaches the top band edge, it re-starts the search from the bottom. If no signals are found, the receiver searches twice more, just in case a station had briefly faded out when the tuner first raced by. If no signals are heard after three passes, the receiver then goes back to the lower band edge, awaiting further instructions.

Just because no strong stations were found in the SEARCH mode, doesn't necessarily mean there aren't weaker stations on the band that could be tuned manually. But for inexperienced listeners, using the SEARCH mode is one way to hear a variety of signals without a lot of extraneous signals to distract you along the way.

If, on the other hand, you know what frequency you want to tune, simply press KEYBOARD (which tells the microprocessor that you're about to enter a frequency on the keyboard) and key in the frequency. With the D2924, you can also store up to six frequencies from any band in the radio's memories using a simple two-button sequence. When you're tuned to one of the stored frequencies, the memory number appears on the LCD display along with the frequency. With receiver memories, you can switch instantly back and forth among broadcasters transmitting on different bands at the same time. Of if you have a set sequence of programs

continued on page 102

SOURCE LIST

General Electric Company
Audio Electronics Products
Syracuse, New York 13221

Magnavox
N.A.P. Consumer Electronics
Corp.
I-40 & Straw Plains Pike
Knoxville, Tennessee 37914

World Radio TV Handbook
c/o Watson Guptill
1515 Broadway
New York, New York 10036

Gilfer Shortwave
Box 239
Park Ridge, New Jersey 07656

MFJ Enterprises, Inc.
921 Louisville Road
Starkville, Mississippi 39759

Sony Corporation of America
Sony Drive
Park Ridge, NJ 07656

Panasonic
One Panasonic Way
Secaucus, New Jersey 07094

Digital IC Tester

An IC tester can be a valuable addition to your test bench. Once you use one, chances are you'll wonder how you ever did without it.

GARY McCLELLAN

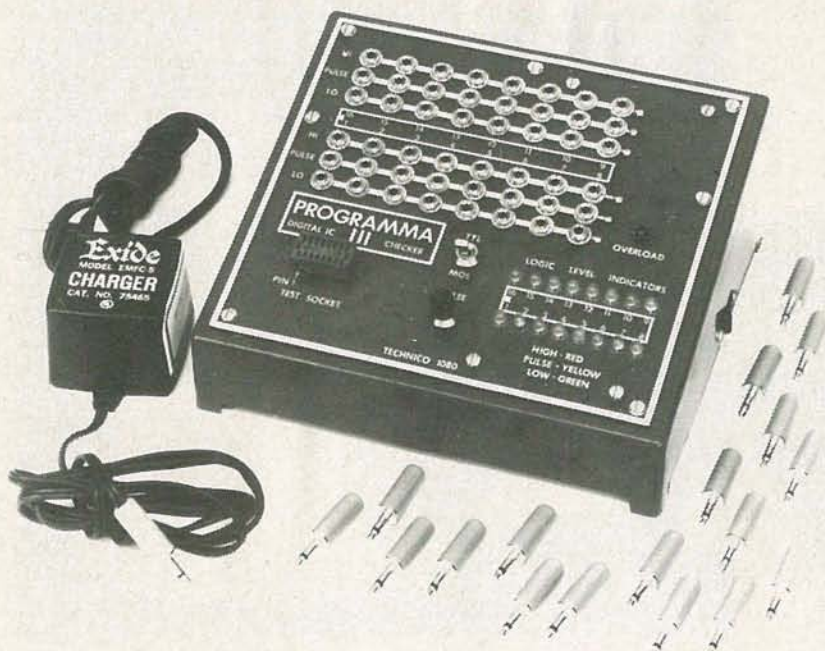

Part 3 WHEN WE LEFT OFF last time, we were almost finished with the panel board. Here, we'll finish that up and complete assembly. Then we'll make sure that everything operates properly.

Now for the cable to the display board; that's shown in Fig. 14. Each lead from the 16-wire cable goes to one of the bus wires you just installed. Be sure you get the kind of cable with a 16 pin DIP plug attached; you'll need that (P101) to mate with the display board. If you can get multicolored ("rainbow") cable, that's better; it will help you trace your wiring.

Measure ten inches of cable from the header end, and cut off the excess. Then separate the wires at the cut end for three inches. Prepare the ends of the wires for soldering. Note that as the wires are connected, pin 1 of the header corresponds to the pin-1 jacks, pin 2 to the pin-2 jacks, etc. To keep things neat, connect the wires for pins 1-8 to the wire near the HI jacks and the wires for pins 9-16 to the wire near the LO jacks; that will allow the cable to run between the two rows of jacks. You'll probably have to use an ohmmeter to identify the wires in the cable because there are so many; jot down the color associated with each pin number on a piece of paper. When you are finished you should have a nice neat assembly like the one shown in Fig. 15.

There are six wire jumpers to be installed next. They aren't obvious because they just go through the board, from one side to the other, connecting the front wiring to the rear. The jumper positions are marked by asterisks (*) in Fig. 14, and are to the left of the jacks. Start at the top

of the board, at the HI jack on pin 9. Run a piece of bare wire through the hole, and bend it over on both sides of the board. Solder it and clip off any excess. Move down to the PULSE jack, and repeat the process. Keep moving down until there are jumpers in all six holes.

Now for the switch and power wiring. Cut 11 pieces of hookup wire six inches long, and prepare one end of each. Still

using Fig. 14 as a reference, solder wires to all the terminals of the two switches, and to the three pads above the OVERLOAD LED. Then carefully solder wires to the leads of that LED. Work quickly and with low heat so you don't damage the device.

Bundle up the wires into a cable, and measure four inches. Cut the wires off at that point. Prepare the ends, and solder them to a 12-pin socket (SO102) to mate

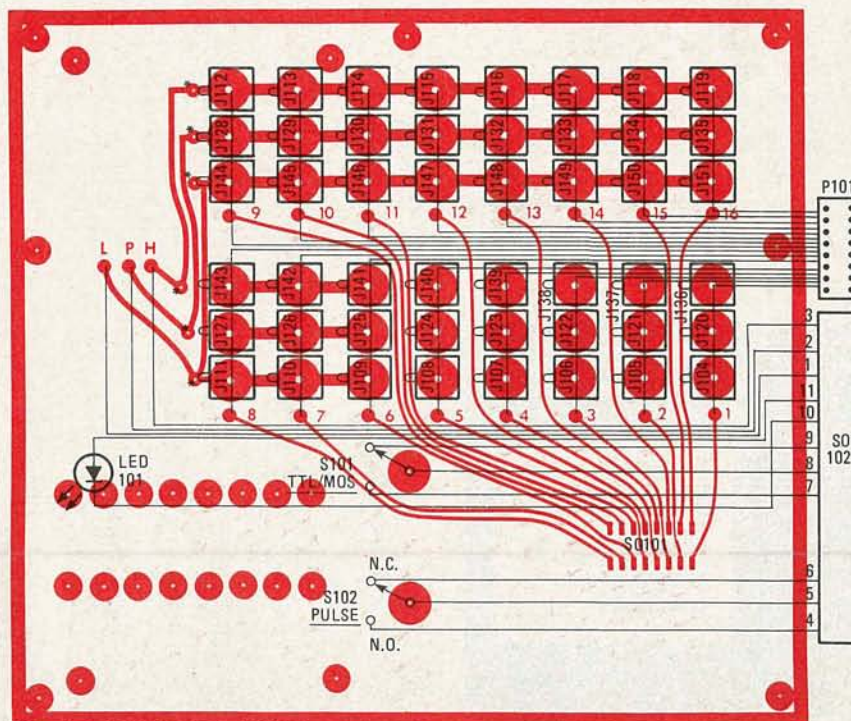

FIG. 14—EACH TRIO OF JACKS is connected to the appropriate pin of the test socket SO101. Separate 11-wire cable goes to SO102, which mates with P102.

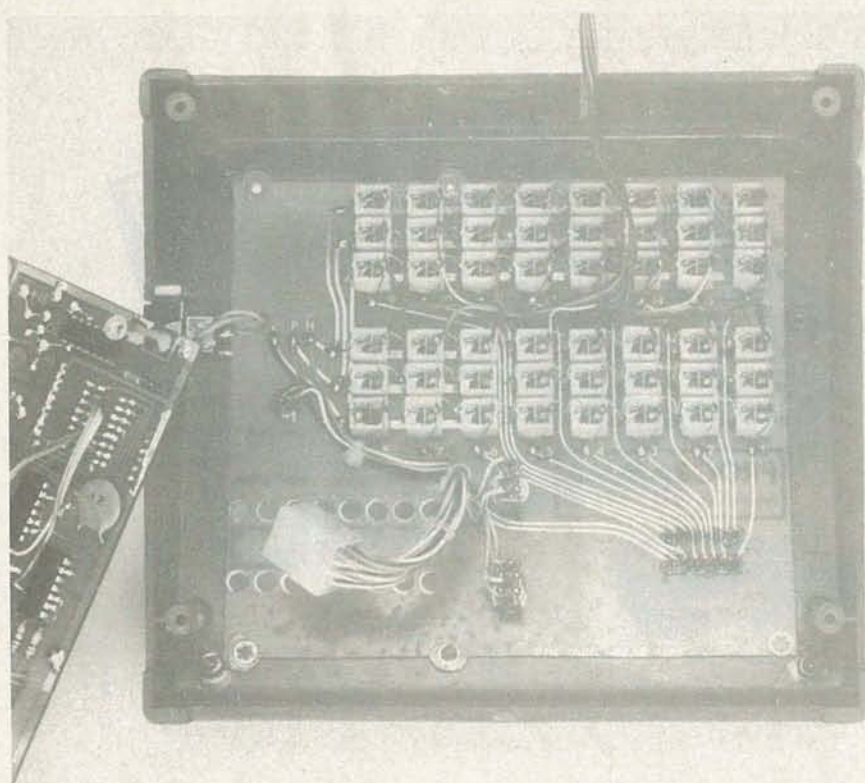

FIG. 15—FOIL SIDE OF COMPLETED PANEL BOARD shows connections to jacks and board, and illustrates routing of wires and cables.

with P102 from the display board. Note that the pushbutton-switch connections may not be what you expect—on the switch I used, the common terminal was at the edge of the body, and not at the center as on the other switch! Save yourself some embarrassment by checking the pinouts marked on the switch body before you wire the connector. Once all the wires are connected, lace them into a professional looking cable. That completes the assembly of the panel board.

Finishing up

At this point, the cabinet should be prepared for installation of the panel board. You'll have to make a large cutout in the top for that board. Start by placing

strips of masking tape along the edges of the box. Then, using the panel board as a template, mark its outside dimensions on the tape with a pencil. Then, measure *in* $\frac{1}{8}$ -inch on each side to allow material for screw mounting of the board; the board will overlap the cutout slightly. (The overlap also allows for a sloppy cut, which will be hidden by the panel board.)

Drill holes at the corners of the cutout, and then use a keyhole saw. After the cutout has been made, drop the panel board in place to check for fit. It may be necessary to file slots for the spacers, but otherwise the fit should be good. Center the board and mark the positions for the seven 0.125-inch ($\frac{1}{8}$ inch) mounting holes. Remove the board, and drill the holes. Finish up by drilling holes for J201 and S201, the power jack and switch. The best place is on the right side of the box, near the bottom. That way, they won't interfere with the boards.

Now for the final assembly, which will go quickly. Clean up the box, removing any tape or shavings. Mount the panel board in place with 4-40 \times $\frac{1}{2}$ hardware. Then install the display board; it should just drop into place. If it doesn't, check for a bent LED. Secure it with 4-40 \times $\frac{1}{4}$ hardware. Now refer to Fig. 16 for the connections between the two boards. Mate S01 and P101 first, then P102 and S0102. Install J201 and S201 on the box next. Connect the power leads from the display board to them. That completes assembly of the IC tester.

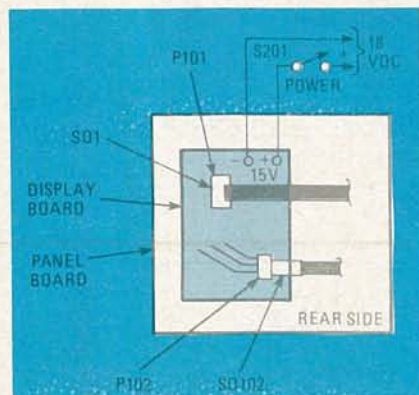

FIG. 16—CONNECTIONS BETWEEN display board and panel board, and display board and power-supply jack.

Power sources

The Programma III is designed to operate from any 12–18-volt-DC power source. If you like, you can build the power supply shown in Fig. 17. You can use any 12.6-volt filament transformer with a capacity of 600 mA or greater.

The last thing you'll need for the IC tester is a number of shorting plugs for the jacks on the device—they select the inputs to each IC pin. Get about 20 miniature phone plugs. Remove the housing from each, and solder the two terminals together. Then, replace the housings. That's all there is to it. Later on, you may want to get more plugs and wire them up for special uses; that will be discussed in the applications section.

Checkout

Now it's time to see if everything works. Apply power and watch the LED's. They should all come on green,

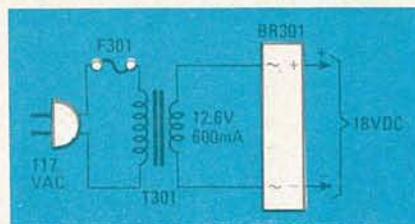

FIG. 17—SIMPLE POWER SUPPLY to provide 18-volts DC for Programma III.

PARTS LIST—POWER SUPPLY

- F301— $\frac{1}{4}$ -amp fast-blow fuse (and holder)
- BR301—50 PIV, 1-amp bridge rectifier
- T301—12.6-volt filament transformer, 600 mA or greater
- P301—2-conductor polarized connector to mate with J201 (phone plug OK)

which indicates that the circuitry is OK. If they don't, unplug P101. That will tell you if there is a short in the display or panel board.

If everything has checked out so far, you can proceed. Insert a plug into the H1 jack for pin 1. Immediately the pin-1 lamp should glow red, indicating a logic-high state. Do the same for the other pins, and if the wrong LED turns red, check the P101 wiring. Then insert a plug into the PULSE jack for pin 1. The pin-1 LED should turn red. If it doesn't, check the PULSE switch wiring. Press the PULSE switch; the LED should change back to green. Press it quickly and repeatedly; the LED should appear yellow. Try the other jacks in the same manner. That completes the checkout.

Applications

The best way to get acquainted with the Programma III is to check some familiar IC's. Once you've seen it in action, you

can go on to more sophisticated applications, like determining the types of "unknown" IC's. You should have at least one good IC data book available for TTL devices, and another for CMOS. That way, you'll know how to connect your IC's. Since both the National and Texas Instruments data books are widely distributed, you should have little trouble getting a copy.

A good way to get started is with the CD4017. It's widely available, and, in addition, causes the tester to produce a spectacular display. The 4017 is a CMOS Johnson counter with ten decoded outputs; it is useful in applications like light sequencers, so you can probably use it elsewhere after testing.

After turning the tester on, since you'll be checking out a CMOS device, set the TTL/MOS switch to MOS. **Do not insert the IC yet!** Next, refer to your manual for the 4017 pinout. In this case, you can use Fig. 18-a.

First, identify the power-supply pins. In the case of the CD4017, V_{SS} is ground, and V_{DD} is positive. Turning to the tester, insert a plug at the LO jack for pin 8. That grounds the pin. (From now on, we'll use a kind of shorthand to indicate plug positions; LO at pin 8 becomes 8-LO.) Then, insert a plug at 16-HI. That supplies power to the IC socket.

The next step is to identify the inputs of the IC. Sometimes you'll have to read the databook carefully to determine what they are for. In the case of the 4017, pin 14 is the clock input, which we will want to pulse. Therefore, insert a plug at 14-PULSE. What about other inputs? The 4017 has both RESET, and CLOCK ENABLE pins. The data sheet indicates that a logic-high on the RESET pin resets the counter. So, insert a plug at 15-LO to make the counter run. As for the CLOCK ENABLE pin, the data sheet shows that it must be at a logic-low for the counter to run. So, insert another plug at 13-LO.

If you don't know the functions of the inputs, you can easily change the plugs around until the device works. Don't confuse the inputs with the outputs, though. You could do some damage.

You can now insert the IC, making sure that pin 1 is positioned properly. (It's clearly indicated on the panel board.) When the ZIF socket is open, no con-

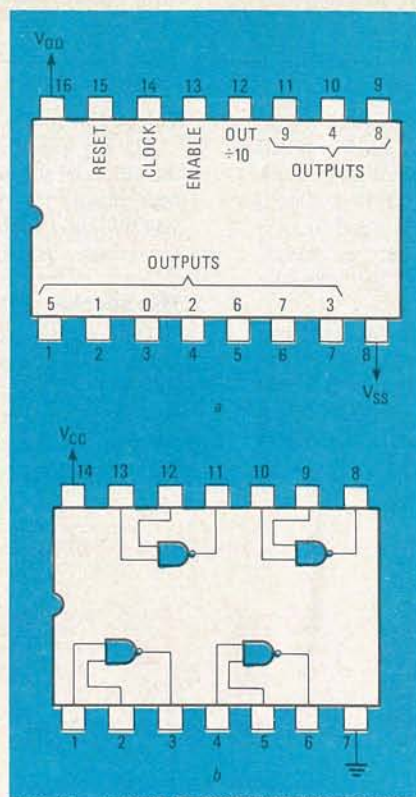

FIG. 18—PINOUT OF 4017 counter is shown in a; that of 7400 in b.

nections are made to the IC pins; it's only when you close it that V_{CC} , input signals, etc., are applied.

Press the PULSE button slowly, and note that different LED's turn red each time. Only one of the outputs will be high at a time, and the LED that corresponds to it will be illuminated. Pressing the button will step the counter, and each output will go high in sequence.

Reset the counter by removing the plug from 15-LO, and inserting it in 15-HI. Then return the plug to 15-LO. The pin-3 LED should be glowing red, indicating that the counter has been reset to zero. Press the PULSE button, and note whether the next LED lights just after the switch is pressed, or as it is released. The 4017 will increment (count up) when you release the switch. That shows that the counter is positive-edge triggered, as the data sheet indicates, because the output of the IC tester's pulse generator is positive-going when the PULSE switch is released. You

have just discovered an important fact: knowing whether a device is positive- or negative-edge triggered is vital when working with counters, flip-flops, and shift registers. Spend some time experimenting with the 4017; change the RESET, CLOCK ENABLE, and CLOCK plugs. You'll quickly learn a great deal about the IC, and have some fun at the same time!

If you "borrowed" your 4017 from another device, and it didn't operate as described above, it's bad! What you've done is to confirm that the IC operates as described in the databook.

That sort of check came in handy for me a while back, when I used a 4017 as a programmable counter. An output was connected to reset, changing the division ratio. The idea was fine for large divisors, but wouldn't work for the small ones. The Program III pinpointed the problem quickly—a "fine print" error in the data sheet.

By now you should have a good idea of how to use your IC checker. For practice, here's another example. Suppose you have a suspect 7400 TTL IC. Here's a brief reprise of the test procedure:

Step 1: Power up the unit. Since the 7400 is a TTL device, the TTL/MOS switch is set to TTL. Do not plug in the IC yet.

Step 2: Look up the IC in your databook. (For your convenience, the pinout is indicated in Fig. 18-b.) Study the illustration.

Step 3: Locate the power and ground pins of the IC. On the 7400, V_{CC} is pin 14 and ground is pin 7. Since the 7400 is a 14-pin device, there will be nothing in the pin-8 and pin-9 positions of the test socket. Always line up IC packages so that pin 1 goes into the pin-1 position of the socket. The pin numbers on that side of the IC will be correct, but you'll have to make adjustments on the other side—pin 16 of the socket is now pin 14 of the IC, so put a plug in 16-HI. Ground is still pin 7, so put a plug at 7-LO.

Step 4: Determine the inputs of the IC, and connect them accordingly. Since the 7400 is a quad (four-section) NAND gate, check each section separately. Since pins 1 and 2 are inputs, you could start with them. Make pin 1 high, and put the pulse on pin 2 for starters. Step 5: Insert the IC, and pulse it. Pin 3 should change state if the IC is good. Change pin 1 to ground, and note that the output doesn't (shouldn't) change state. Transpose the inputs to pins 1 and pin 2 and repeat the tests. Check the other gates in the same manner. If they work, fine! Don't bother to continue testing if you detect a fault, unless you need to use only a part of the IC.

That, in a nutshell, is the technique for testing IC's. With a little practice, it becomes routine and, after a while, you can introduce some shortcuts. For example, once the power and ground pins of the test socket are connected, the IC may be inserted. Just don't get careless when you insert the plugs—most IC's object strong-

continued on page 100

OOOOOOPS!

In going from Part 1 to Part 2 to Part 3 of this article, several connector designations were confused. The following will, we hope, correct that confusion.

| Description | Part no. | Connects with |
|---------------------|----------|-----------------------|
| 12-pin Molex plug | P102 | SO102 |
| 12-pin Molex socket | SO102 | P102 |
| 16-pin IC socket | SO1 | P101 |
| 16-pin DIP header | P101 | SO1 |
| 16-pin ZIF socket | SO101 | panel board |
| Power jack | J201 | P301 |
| Power plug | P301 | J201 |
| Power switch | S201 | pads on display board |

HOW TO

WHILE MOST COLLECTIBLE RADIOS ARE NOT OLD ENOUGH TO BE classified with antique furniture, many of them can be called antiques in their own right. You may be young enough to think that a radio from the thirties or forties is old. And, if you are a newcomer to the hobby of collecting radios, it is good to start with radios from that era because there are plenty to choose from. Often, you can even get such a radio for free. But, can it be restored?

As with any type of restoration, the task begins with what you have to work with in the first place. There are many old radios that are not worth restoring. (Of course, any radio that you identify with in some special way is worth restoring.) Also, some old radios are considered to be more of a classic than others (such as the cathedral-cabinet table model) and are more in demand. If you find one of these "classics" cheap, take it—no matter what the condition. Later, you may find another, and make one complete, working set.

When restoring an old radio, it is important to keep it as original as possible. That applies to everything from the chassis and parts to the knobs and the finish on the wood cabinet. That does not apply if you want only a working conversation piece and not a truly-restored radio. Any good cabinet can be fitted with a working radio chassis with a little alteration. Remember that proper ventilation and insulation must be observed. Although you might not have the rich, deep tone of the original, any modern radio in a cabinet from the thirties in daily use in your home will attract much attention.

Where to find old restorable radios

Radios that can be restored are all around—but not in your local TV and appliance store. Try the classified ad columns, flea markets, and garage and yard sales. There are also many ads in magazines dedicated to this hobby. One example is *The Horn Speaker* (9820 Silver Meadow Dr., Dallas, Texas 75217). Some of your friends and relatives may have an old radio lying around for the asking. Of course you have to know what to look for when trying to find a radio to restore. We'll go into that next.

First, the radio should be old (whatever is old to you) and should have most if not all of its parts. The cabinet will be the first thing you will see. Can the cabinet be refinished to some semblance of its original condition? (Only knowing your own limits and abilities in wood-working and refinishing can answer that.) Are the knobs there? If not, you can most likely get some

that fit and look original.

The big question is: Does it play? Ask the seller if he can play the old radio for you, or at least turn it on. If the old radio hasn't been played for years and the line cord and plug are corroded, you will have to rely on just what you can see. That will include the speaker assembly, the chassis, and the cabinet.

The speaker assembly

The speaker assembly is a monstrous arrangement in old radios. Along with the cone and the voice coil, there is a field coil and impedance-matching transformer all mounted on a massive frame (see Fig. 1). That array, called an electrodynamic speaker should be intact, even if it needs a little work. While it may be possible to replace the dynamic speaker with a

PM (Permanant Magnet) type, it will take much from the originality. The most visible problem might be the speaker cone. Finding a fifty-year-old radio with a speaker cone that is not warped or torn will be rare. If the cone isn't torn badly, it can usually be repaired with a little speaker cement, available in any parts shop. A warped speaker cone is not as obvious as a torn cone, but it is just as easy to repair.

Any radio that has not been used for many years is likely to have at least one of those speaker-cone problems. Checking for a warped speaker cone is a fairly simple procedure. With the set off and unplugged, of course, remove the speaker and examine the cone. (The wires are usually long enough to turn the speaker around without having to cut them.) A warped cone can cause an off-

center voice coil. To determine if the voice coil is off center, apply a slight pressure around the center of the cone as shown in Fig. 2. If a scratching noise is heard, the voice coil is off center. That test must be done very carefully or you may put your finger through the cone. If you hear the scratching noise, all is not lost, for there are a few things that can be done to re-center the voice coil. Some old sets have small set-screws in the center of the cone that need simply be adjusted to re-center the voice coil. Also, the outer edge of the cone may be reglued to the frame to solve the problem.

Even if your speaker cone is completely tattered there is still hope. There are still a few places around that re-cone speakers. The cost of re-coning the old speaker will not be much more than buying a PM speaker and you will avoid the electrical and physical conversion problem. Also, keeping the set original will

REPAIR ANTIQUE RADIOS

Repairing an old radio and restoring its original performance and looks can be a source of pride. Let's take a look at the basics of this rewarding and challenging hobby.

RICHARD D. FITCH

always be an asset when showing or discussing your restored set to knowledgeable people.

If you are unable to pass a signal through the speaker because of unrelated problems with things such as tubes, line cords, etc., make a continuity test of the speaker components. With the set off and unplugged, check the voice coil, field coil, and both sides of the output transformer. Any inexpensive ohmmeter can be used, as the exact resistance is not important at this time. If you should fail to find continuity at any one of those points, the problem may be less than an inch away. The soldered connection where the coil or transformer is joined to the lead wire is the most likely culprit. You might have to carefully remove a little paper from the transformer to get to the connection. Even if there is no obvious break at the connection it still may have built up corrosion or a resin block. All those connections should be resoldered to make a good contact so they will cause no future problems.

The chassis

You can get a wealth of information from the chassis just by looking at it. Naturally, the first question to ask is whether or not all the parts are there. It will be easy to see if there are any tubes missing. Finding tubes for those that are missing will be one of the easier chores. Many old sets had the tube number stamped on the socket or on the chassis near the socket. It might be your good fortune to find a legible diagram with all pertinent information (such as the model number, IF frequency, tube locations, and filament diagram where applicable) fixed to the inside of the cabinet. Missing chassis parts other than tubes can create big problems. If an exact or a similar schematic isn't available, finding out what was in that hole with the wires hanging out will challenge even an expert. Large, tapped, wire-wound resistors, capacitors, IF transformers, and coils are some of the parts that may have been ripped from a chassis over the years. Unless you have full schematic information or for some reason want the set very badly, pass it up if it has parts missing other than tubes and knobs.

Some old radios seem to withstand age better than others. Where a radio was stored is especially responsible for its condition, as is the quality of material used in its manufacture. One chassis may be completely corroded and have a cabinet warped beyond repair, while another of the same vintage—maybe even of the same make—will appear like-new. A corroded chassis can entail a lot more work than a warped cabinet and can make

the project not worth your while. What's so serious about a corroded chassis? There are two big problems—the tube sockets and potentiometers. If the tubes are corroded in the sockets, removing them without any further damage to the tube or socket will take much patience—and a lot of solvent. And, you will still have a rusted socket when you are finished. To answer any question about the extent of the corrosion, you will have to remove the chassis from the cabinet for a look underneath. Often the underside of the chassis will be spared the corrosion and rust that was evident on top.

Cabinet restoration

How well the cabinet can be restored is limited mostly by your own ability. If you enjoy woodworking and do it well, almost any cabinet can be restored. Even a cabinet with the plies separated can be re-glued. It is important that you take care to preserve any decals or designs (like that shown in Fig. 3) on the front of the cabinet. Before removing the finish, try restoring it with polish. However, if the finish must be removed, light-sand over those areas. Sometimes, furniture polish will restore an old finish and cover up minor scratches. If there are any deep scratches or dents, wood filler can be used. However, since the wood filler will rarely match the original cabinet, it will have to be tinted after the final finish is started so that it won't show through.

Before attempting any work on the cabinet, be sure to remove everything from inside. Also, all removable name plates, decorative speaker bolts, and even the grill cloth should be removed. Getting sanding dust and paint products on the chassis parts will not do anything to improve your old radio. If any parts of the cabinet are beyond restoration, they may be able to be replaced by a patient woodworker. That will apply most often to the bottom of a cabinet that absorbed moisture because it was stored in a damp place. Just be sure to replace any vent holes that were in the original cabinet, because an old radio with its big tubes and wirewound resistors radiates considerable heat.

Troubleshooting old radios

Troubleshooting old radios is not much different than troubleshooting new radios. (And it is just as important to be familiar with all safety procedures.) Many old radios have the grid cap conveniently sticking out the top of the tube envelope.

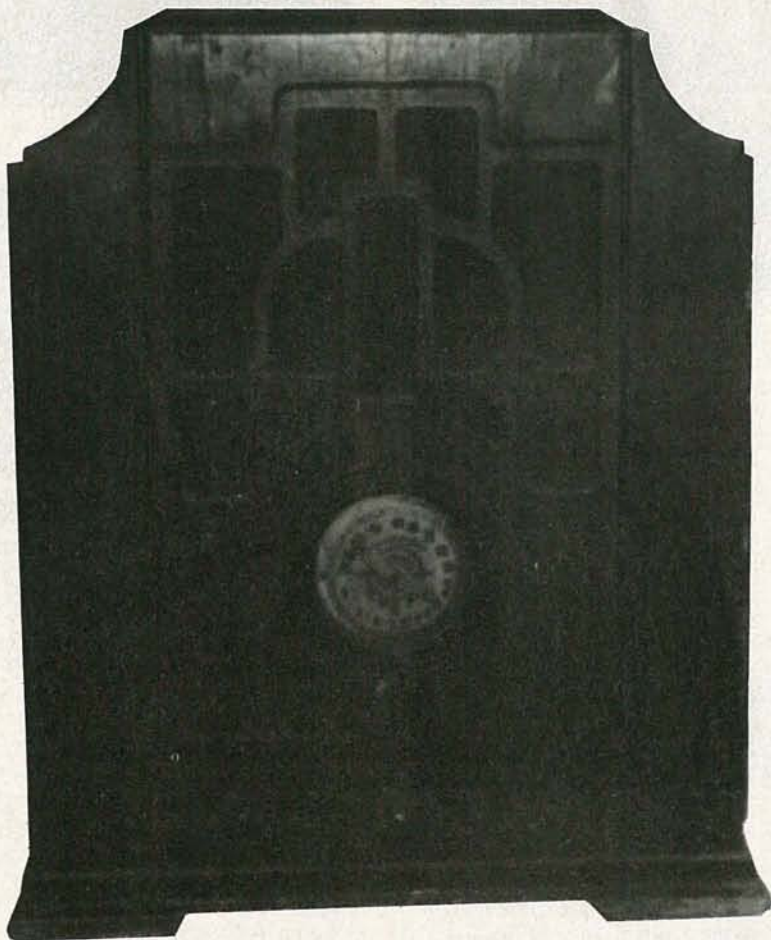



FIG. 1.—MAKE SURE WHEN BUYING an old radio that all chassis parts are included. Without a schematic it may be impossible to identify a missing part.

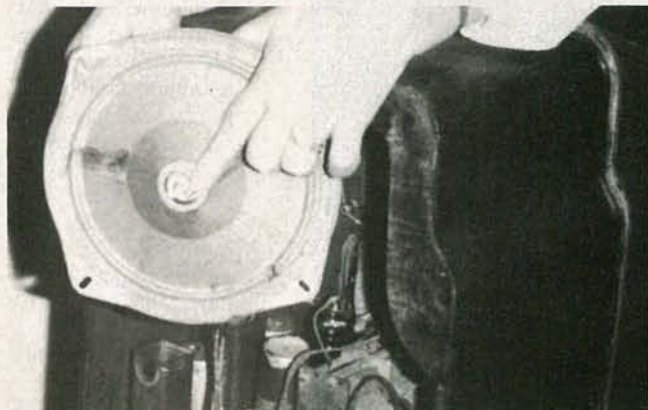

FIG. 2.—THERE IS A SIMPLE TEST to determine whether or not the speaker's voice coil is off center.

That permits a signal injection or circuit-disturbance test without even removing the chassis from the cabinet. Most of the rest of the parts are similar to those in newer radios, but are much larger, of course.

When you select an old radio to restore, don't be surprised if it lights up but doesn't play. Even if there is just some slight hum from the speaker don't give up hope. There are a few factors to consider on early models that should be checked. If there is no built-in aerial, there should be a terminal on the back of the chassis for connection to an external one. (The radio might play weakly or not at all if it was designed to use an outside aerial.) Any piece of wire can be attached to the terminal screw for test purposes.

Keeping the equipment original is not as difficult as it sounds. The band switches, potentiometers, coils, and even IF transformers can be dismantled and repaired. As with speakers, the most likely problem with an intermediate-frequency transformer that will not pass a signal is a poor connection. Remove

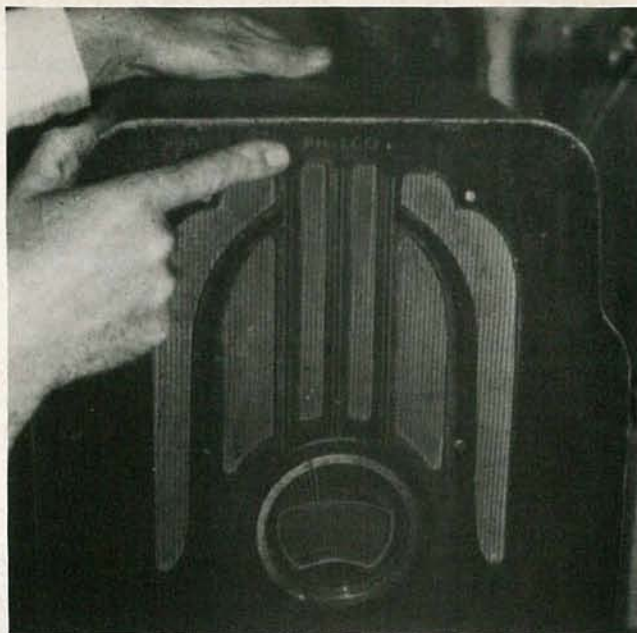

FIG. 3.—WHEN RESTORING A CABINET, take great care to preserve any decals or designs.



FIG. 4.—A TUBE TESTER can save you a lot of time and aggravation, especially if you buy a large numbers of used tubes.

the transformer's shield and carefully resolder all of the connections. (A turn can even be taken from the winding if more of the hair-like wire is needed to make a good connection to the trimmer terminal.) If you have to remove the trimmer screw to clean it, you will want to reset it as closely as possible to its original position. You can do that by counting the turns as you screw it down as far as it will go. Then remove the screw and clean it and the trimmer if needed. Replace the screw and turn it as far in as it will go, then back it off the number of turns needed. You will probably have to align the entire set after the IF transformer work.

There isn't much that can be done to repair a bad tube. A partial solution is a good collection of used tubes. Also, there are still some mail-order houses offering old tubes. Even some long-established repair shops have some tubes for early sets. One source for tubes and information that comes to mind is Puett Electronics (P.O. Box 28572, Dallas, TX 75228). A tube tester with an older roll-chart, like the one shown in Fig. 4, is a priceless piece of equipment for the old-radio buff.

Even if restoring your nostalgic radio ends up costing you more than the radio did when it was new, the pleasure of restoring it and the pride of accomplishment can far outweigh the cost. And, if that's not enough, you can expect many offers to buy your restored radio.

R-E

BUILD THIS

Two Compact DVM's

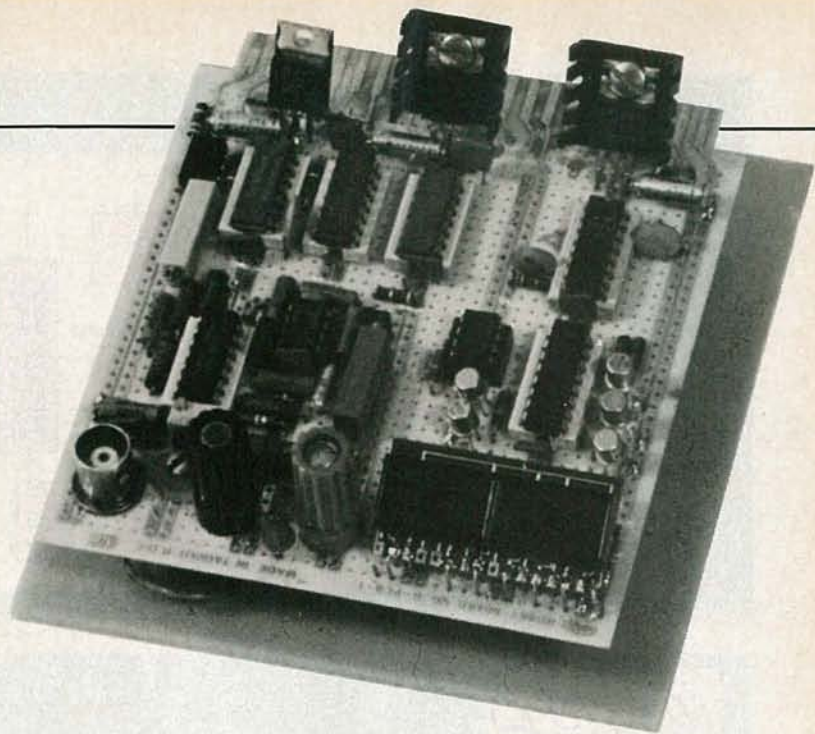

Equip your bench power-supply with its own digital voltmeter. LSI circuits make the project simple and inexpensive.

CLEMENT S. PEPPER

THE POWER SUPPLY I USE ON MY BENCH has five outputs, two of which are variable over a range of ± 25 volts. I found having to connect a voltmeter to either of those two merely to set a voltage or to make a status check to be a bother, and was thinking of adding an analog panel meter with selector switching, when I stopped to ask myself why I wanted to do a dumb thing like that. High performance linear and digital IC's now available make a built-in digital voltmeter practical at about the same cost as a high quality panel meter. All the semiconductors and the 4-digit display, for example, can be purchased for less than twenty-five dollars.

The circuit I designed performed so well that I modified it and made a general-purpose DVM for use on the bench. It is quite compact, so it can be close to the work at hand while taking up little space.

At the heart of both versions is the LM331 precision voltage-to-frequency converter. That device, along with the MM740925 (a 4-digit counter with multiplexed 7-segment output drivers) and the NSB3881 4-digit common-cathode multiplexed LED display, contributes to the high performance and compact construction of the DVM's. All three IC's are made by the National Semiconductor Corporation.

LM331 V-to-F converter

The LM331 is a monolithic circuit designed for voltage-to-frequency or frequency-to-voltage conversion. Figure 1 shows the LM331 in simplified block-diagram form, along with the external resistors and capacitors needed for stand-alone V-F operation. The principal parts

of the device are a switched current-source, an input comparator, and a one-shot timer.

The switched current-source establishes a positive reference voltage, V_X , as one input to the comparator, and a positive input-voltage, V_{IN} , as the second. If V_{IN} exceeds V_X , the comparator will trigger the one-shot. The one-shot then turns on the output transistor and the switched current-source for a time, t , equal to $1.1R_C C_T$. During that time, current i provides a fixed charge Q , equal to $i_X t$, to capacitor C_L . That will normally raise V_X to a higher level than V_{IN} . At the end of the timing period, current i will turn off, and the timer will reset itself. Since there is then no current flowing from pin 1, capacitor C_L is gradually discharged by resistance R_L until V_X falls to the level of V_{IN} . Then the cycle will repeat.

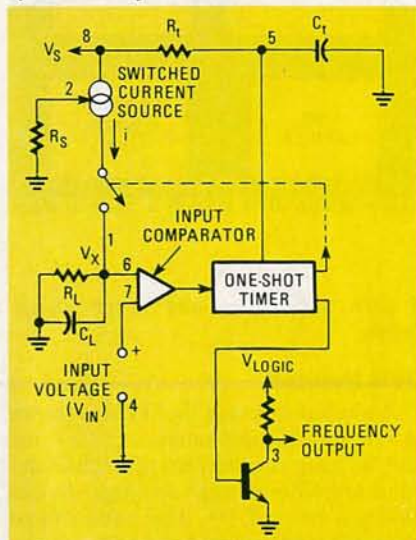

FIG. 1—SIMPLIFIED BLOCK DIAGRAM of voltage-to-frequency converter showing LM331 with external components

The output device is an open-collector transistor, a real convenience in translating between the 15-volt supply for the converter and the 5-volt one for the display. The output is a train of negative-going pulses that is input directly to the counter's clock input for counting and count display. The output frequency is given by the equation:

$$F_{OUT} = V_{IN}/2.09 \times R_S/R_{IN} \times 1/R_C C_T$$

The current flowing into C_L is $i_{AVE} = i \times (1.1R_C C_T) \times F_{OUT}$, and the current flowing from C_L is exactly V_X/R_L , which, in turn, is very nearly equal to V_{IN}/R_L . If V_{IN} is doubled, F_{OUT} will also double to maintain that balance. The converter can provide an output that is proportional to its input voltage over a broad range of frequencies. The voltage-to-frequency linearity in a circuit having values very nearly the same as those in the two versions of the DVM described here, is specified by National as $\pm 0.14\%$ worst-case over the range of 10 Hz to 11 kHz.

MM74C925 4-digit counter

The MM74C925, shown in Fig. 2, is a CMOS device containing a 4-digit decade counter, an internal latch, NPN output sourcing drivers for a 7-segment display, and internal multiplexing circuitry with four multiplexing outputs. It has its own free-running oscillator; no external clock is required for digit strobing. The counters advance on the negative edge of the incoming clock signal. A high on the RESET input will reset the counter to zero. A high on the LATCH ENABLE input allows data to flow through the counters without being latched; a low latches the number in the counters. The display can be driven

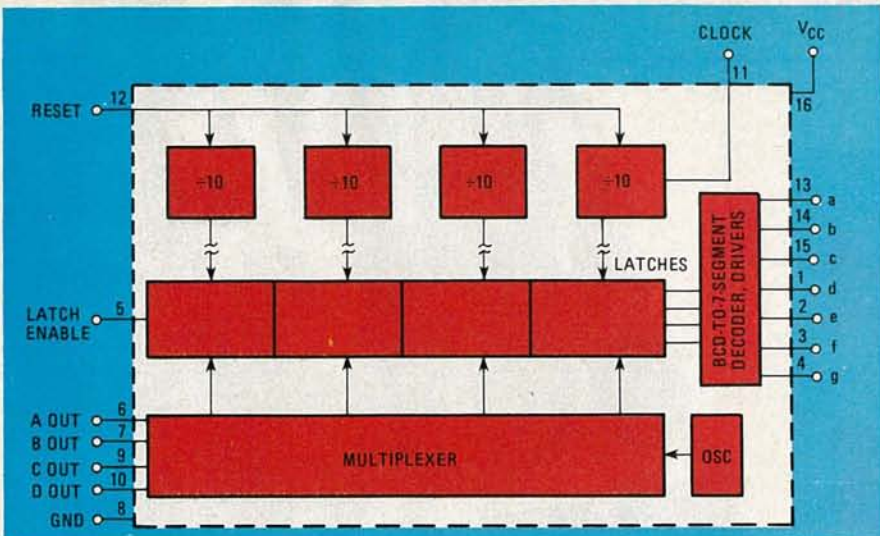

FIG. 2—INTERNAL STRUCTURE of 74C925 4-digit counter with multiplexed 7-segment output drivers.

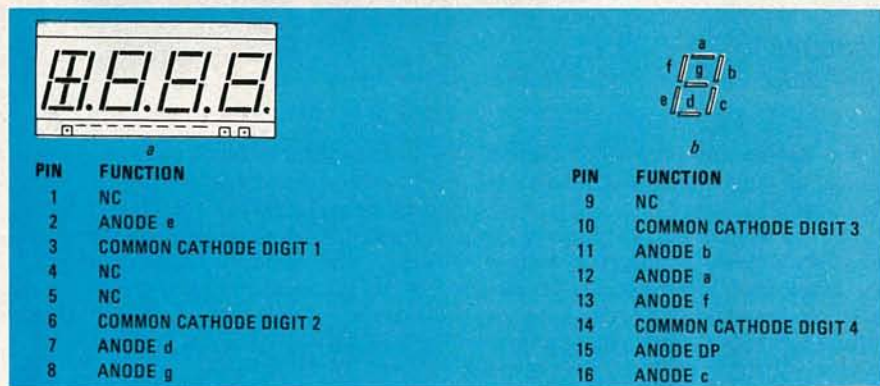

FIG. 3—NATIONAL SEMICONDUCTOR NSB3881 4-digit LED display.

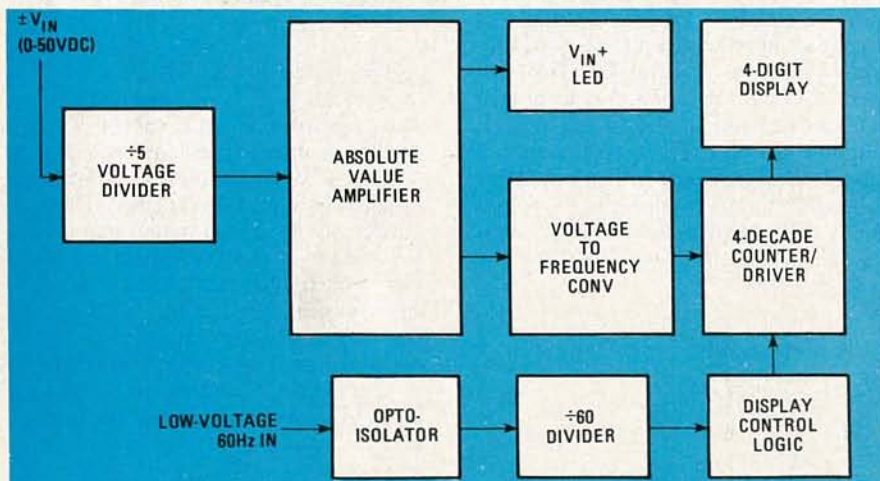

FIG. 4—BLOCK DIAGRAM of general-purpose DVM. Low-voltage 60-Hz current is used to clock display control-logic.

without external segment-current-limiting resistors, but they should be used to minimize power dissipation and chip heating.

NSB3881 4-digit LED display

The NSB3881 is one of a family of multidigit LED-displays mounted on a small PC card, which greatly simplifies assembly and wiring. The individual digits are prematched for brightness and are mounted so as to be end stackable. Figure

3 shows the display and its pin assignments.

DVM features

A block diagram of the DVM is shown in Fig. 4. The input range is ± 50 volts, and the input is connected to an absolute-value amplifier through a voltage divider having a ratio of 1:5. That ratio can be changed—it just happened to meet my needs. The one strict requirement is that the maximum voltage to be measured re-

PARTS LIST—GENERAL PURPOSE DVM

All resistors 1%, 1/4 watt unless otherwise specified

- R1—1 megohm
- R2—20,000 ohms, multi-turn trimmer potentiometer
- R3—250,000 ohms
- R4—200,000 ohms
- R5, R6, R8, R12—10,000 ohms
- R7, R11—5000 ohms
- R9—1000 ohms, multi-turn trimmer potentiometer
- R10—4750 ohms
- R13, R15—100,000 ohms
- R14—47 ohms, 5%
- R16—5620 ohms
- R17—10,000 ohms, 5%
- R18—10,000 ohms, multi-turn trimmer potentiometer
- R19—6800 ohms
- R20, R23, R36—1000 ohms, 5%
- R21—220 ohms, 5%
- R22—see Table 1
- R24-R26, R35—3300 ohms, 5%
- R27-R34—82 ohms, 5%

Capacitors

- C1, C3, C5, C7-C10—0.1 μ F, ceramic disc
- C2—1000 pF, ceramic disc
- C4—1 μ F, Mylar or tantalum
- C6, C11-C13—0.01 μ F, ceramic disc

Semiconductors

- IC1—TL084C quad biFET op-amp
- IC2—LM311N (or -H) voltage comparator
- IC3—LM331N precision voltage-to-frequency converter
- IC4—74121 monostable multivibrator
- IC5—7492 divide-by-12 ripple counter
- IC6—7490 divide-by-10 ripple counter
- IC7—74123 dual monostable multivibrator
- IC8—74C925 CMOS 4-digit counter w/multiplexed digit and segment drivers
- IC9—MCT2E opto-coupler
- DISP1—NSB3881 4-digit, 7-segment LED display
- LED1—jumbo red LED
- Q1—2N2907
- Q2-Q5—2N2222
- D1, D2—1N914

Miscellaneous: regulated power supply, perforated construction board, IC sockets, hardware, etc.

sult in a V_{IN} to the voltage-to-frequency converter of no more than ten volts. That will keep the maximum signal within the linear operating range of the operational amplifier.

The output of the absolute-value amplifier is always positive, regardless of the polarity of the input voltage. That's necessary because of the input requirements of the LM331. An output is also taken from pin 7 of the amplifier (IC1-b) to light an LED and provide a visible indication of the polarity of the input. When the LED is lit, the voltage is positive; when it's dark, it's negative.

The 60-Hz line current serves as the clock source for the display. Division by 60 provides a one-second timebase. (The

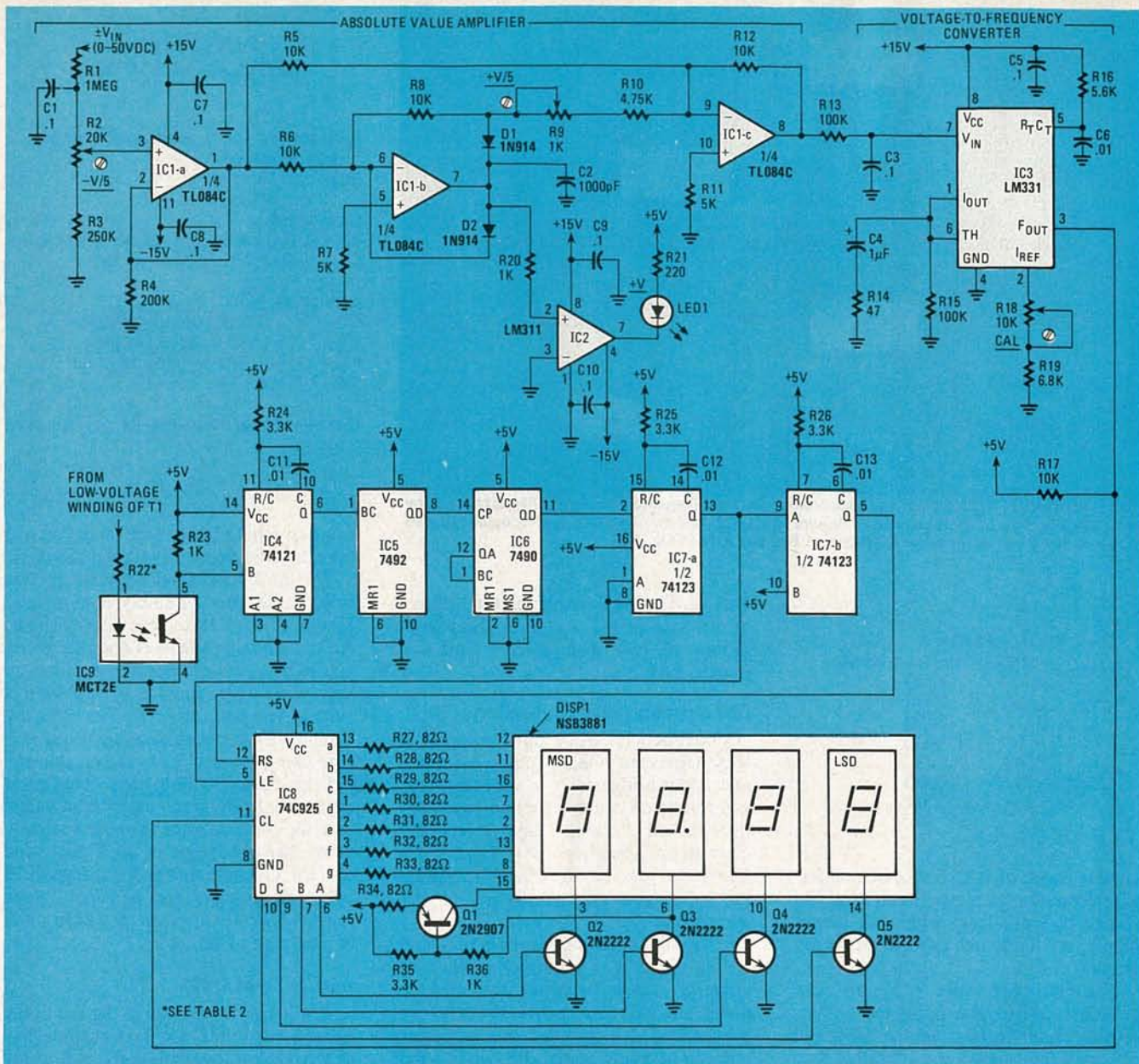

FIG. 5—CIRCUITRY IN UPPER PART of schematic of general-purpose DVM contains absolute-value amplifier and V-F converter. Lower section is for timing and display.

equation for F_{OUT} assumes a one-second timebase.) However, any clock frequency can be used, provided that F_{OUT} stays the same. The easiest component to change to compensate for a different timebase is R_5 .

A schematic of the general-purpose voltmeter circuit is shown in Fig. 5. The TL084C quad bi-FET op-amp is used primarily because its very low bias currents allow the use of high-value resistors for the input divider.

Figure 6 helps to explain how the absolute-value amplifier section works. When V_{IN} goes negative, the output of the first amplifier goes positive by the amount of one diode-voltage-drop (about 0.7 volt), shutting off the upper diode and bypassing the amplifier by virtue of the lower diode connected to the input. The second amplifier inverts V_{IN} to provide a

positive output equal in amplitude to the negative input. When V_{IN} is positive, both amplifiers invert, but the output of the first is $-2V_{IN}$ which, when summed with V_{IN} at the input to the second, results in an actual input equal to $-V_{IN}$, and thus an output of V_{IN} .

Referring once more to Fig. 5, the second amplifier, IC1-b, is connected to the non-inverting input of a LM311 comparator. Whenever V_{IN} is positive, that input is negative and the LED lights. The three trimmer potentiometers should be preset to approximately midpoint for R_2 and R_9 and to about 6000 ohms for R_{18} . The National data book suggests that C_4 be a Mylar capacitor, but I used a tantalum with no apparent problems. If you are looking for accuracy on the order of one percent or so, and good long-time stability, you should use cermet trimmers and

metal-film resistors throughout the amplifier and converter circuits.

As shown in Fig. 7, an opto-coupler is used to extract a clock signal from the low-voltage winding of the transformer used by the power supply that will be monitored. Table 1 will help you select a

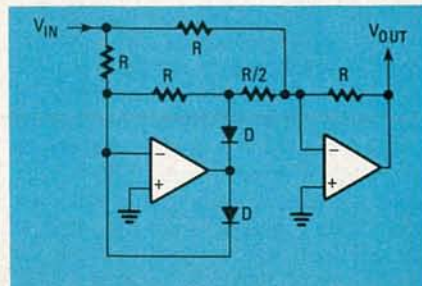

FIG. 6—ABSOLUTE-VALUE amplifier uses two diodes to "decide" whether input voltage is positive or negative.

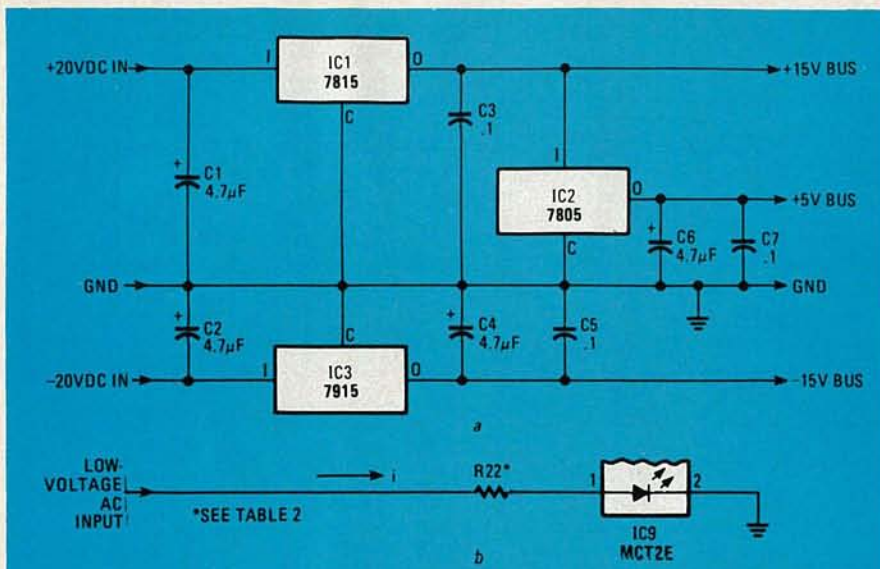

FIG. 7—POWER IS TAKEN from power supply being metered. Regulators provide voltages required by meter circuits. Two positive regulators require heatsinks. Resistor R22 and opto-coupler IC9 also appear in Fig. 5 and serve same functions as R20 and IC14 in Fig. 11.

TABLE 1

| V_{rms} | R22 (R20) ($I_{rms} = 20mA$) |
|-----------|--------------------------------|
| 7 | 270 Ω |
| 10 | 390 Ω |
| 13 | 560 Ω |
| 16 | 680 Ω |
| 19 | 820 Ω |
| 22 | 1000 Ω |
| 25 | 1200 Ω |

suitable value of R22 for your transformer. Power for the meter circuit itself can also be obtained from within the power supply; ± 18 -20 volts DC will do the job nicely.

The 60-Hz divider is quite conventional. When you build the circuit, keep in mind the fact that the 7490 and 7492 power pins are 5 and 10, rather than the more common 14 and 7 for V_{CC} and ground, respectively. The leading edge of the output of the 7490 triggers IC7-a, a 74123 dual monostable-multivibrator. The output pulse, which has a duration of about ten microseconds, latches data from the 74C925 counter (IC8) for display updating. Its trailing edge triggers IC7-b to reset the counter.

The 74C925 is capable of driving the display directly—that is, without current-limiting resistors—but then you must heat-sink the counter, and you may have a power-supply problem as well. The 82-ohm current-limiting resistors provide more-than-adequate brightness for good readability on a well-lighted bench. The 2N2907 transistor is used to turn on the second-digit decimal point. The counter does not feature leading-zero blanking, and I didn't think it worth the effort to include it. If you do wish to blank the leading zero, add logic to detect when segments "a-f" are at a logic-high, and segment "g" and pins 7, 9, and 10 of IC 8

are low. The logic should inhibit the drive to the base of Q2 whenever those conditions are met, and the first digit will remain dark.

Construction and calibration

Construction can be quite compact if reasonable care is taken to prevent shorts and solder bridges. There are two things you should do to avoid oscillations: Connect 0.1- μ F ceramic capacitors fairly close to the amplifier's "+" and "-" DC-power pins, and take care to separate the input and output circuits of the amplifiers.

I usually combine construction and testing. That is, I construct a block of circuitry, such as the analog portion of the meter, and then stop to check it out before proceeding. I assembled the amplifier and comparator circuits, followed by the voltage-to-frequency converter, the time-base, and the display.

It's a good idea to assemble the amplifier circuit, then stop to test and adjust it, before connecting it to the LM331. The reason is that the voltage-to-frequency converter will respond to positive voltages only, but should there be a defect in the amplifier wiring you could input a negative voltage. (That's because the initial step in the test-and-adjustment procedure is to connect a negative voltage to the input.) With a calibrated meter connected to pin 8 of the TLO84CN, apply a known negative voltage to the input of the meter you built. You should read a positive voltage equal to one-fifth the input. Adjust R2 to obtain that value.

Next, replace the negative voltage with a positive one of a similar amplitude and adjust R9 for the correct reading—again one-fifth the value of the input voltage. There is a somewhat larger error for a positive input than for a negative one, so you may want to make the adjustment

PARTS LIST—REGULATOR SECTION

All resistors 1%, 1/4 watt unless otherwise specified
R22—see Table 1

Capacitors

C1, C2, C4, C6—4.7 μ F, 25 volts, tantalum
C3, C5, C7—0.1 μ F, ceramic disc

Semiconductors

IC1—7815 15-volt positive regulator
IC2—7805 5-volt positive regulator
IC3—7915 15-volt negative regulator
IC9—MCT2E

Miscellaneous: heatsinks for positive regulators

using an input voltage of a value you will be measuring frequently (I used 15 volts).

The third—and final—adjustment has to be made after assembly is complete. Simply adjust R18 so your display shows the same input-voltage as does the meter you're using for calibration. Again, you may wish to perform that step with a voltage you use often. At 1 1/2 volts my completed meter displayed a positive voltage that exceeded its negative counterpart by about 30 millivolts. That error approached zero at my calibration value; then the positive error increased slightly more than the negative as I continued upward. Overall, with an input span of 20 volts, the positive and negative values tracked my calibration meter within about two percent of full scale.

A dual-input DVM

The longish rectangle to the left of the banana plug in Fig. 8 is the 4-digit display of a version of the DVM that monitors my power supply's variable outputs (the jacks between the two knobs). That version features two inputs—one for a positive voltage, the other for a negative one. Because the range of the supply is about 27 volts, I designed the meter circuit to span 30 volts. I constructed the circuit in three sections, as can be seen in Fig. 9, so I could tuck it all into the cramped space available inside the supply.

A function diagram of that meter is shown in Fig. 10. An inverting amplifier is required for the negative input; a non-inverting one for the positive, so that each provides a positive source for the voltage-to-frequency converter. Connection to the converter is made through a solid-state analog switch controlled by measurement logic derived from the one-second timing logic. The control logic for the display differs somewhat from that of the general purpose DVM, but the remainder of the circuitry is the same.

A schematic of the dual-voltage meter is shown in Fig. 11. A general-purpose

PARTS LIST—DUAL-INPUT DVM

All resistors 1%, 1/4 watt unless otherwise specified

R1, R3—20,000 ohms
 R2, R4-R6—10,000 ohms
 R7, R19—10,000 ohms, multi-turn trimmer potentiometer
 R8—8200 ohms, 5%
 R9, R10—5600 ohms, 5%
 R11, R17—100,000 ohms
 R12—47 ohms, 5%
 R13—4700 ohms, 5%
 R14, R16—10,000 ohms, 5%
 R15—5600 ohms
 R18—220 ohms, 5%
 R20—see Table 1
 R21, R34—1000 ohms, 5%
 R22-R24, R33—3300 ohms, 5%
 R25-R32—180 ohms, 5%

Capacitors

C1, C5, C10-C12—0.01 μ F, ceramic disc
 C2, C4, C6-C9—0.1 μ F, ceramic disc
 C3—1 μ F, Mylar or tantalum

Semiconductors

IC1, IC2—741 op-amp
 IC3—4016 CMOS quad bilateral switch
 IC4—7407 hex buffer, open collector
 IC5—LM331N precision voltage-to-frequency converter
 IC6—74121 monostable multivibrator
 IC7—7492 divide-by-12 ripple counter
 IC8—7490 divide-by-10 ripple counter
 IC9—7474 dual D flip-flop
 IC10—7408 quad 2-input NAND gate
 IC11—7432 quad 2-input OR gate
 IC12—74123 dual monostable multivibrator
 IC13—74C925 CMOS 4-digit counter with multiplexed digit and segment drivers
 IC14—MCT2E opto-coupler
 DISP1—NSB3881 4-digit, 7-segment LED display
 Q1, Q3-Q6—2N2222
 Q2—2N2907

Miscellaneous: regulated power supply, perforated construction board, IC sockets, hardware, etc.

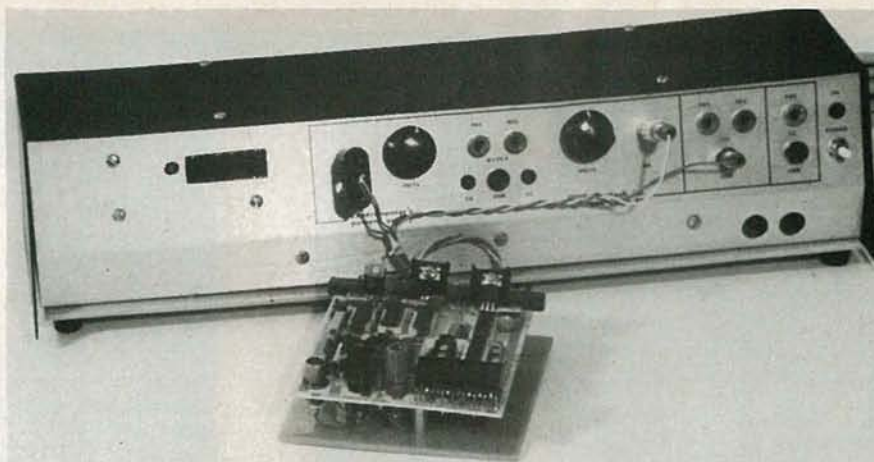

FIG. 8—DISPLAY OF DUAL-INPUT DVM can be seen at left of power supply. General purpose DVM is in foreground.

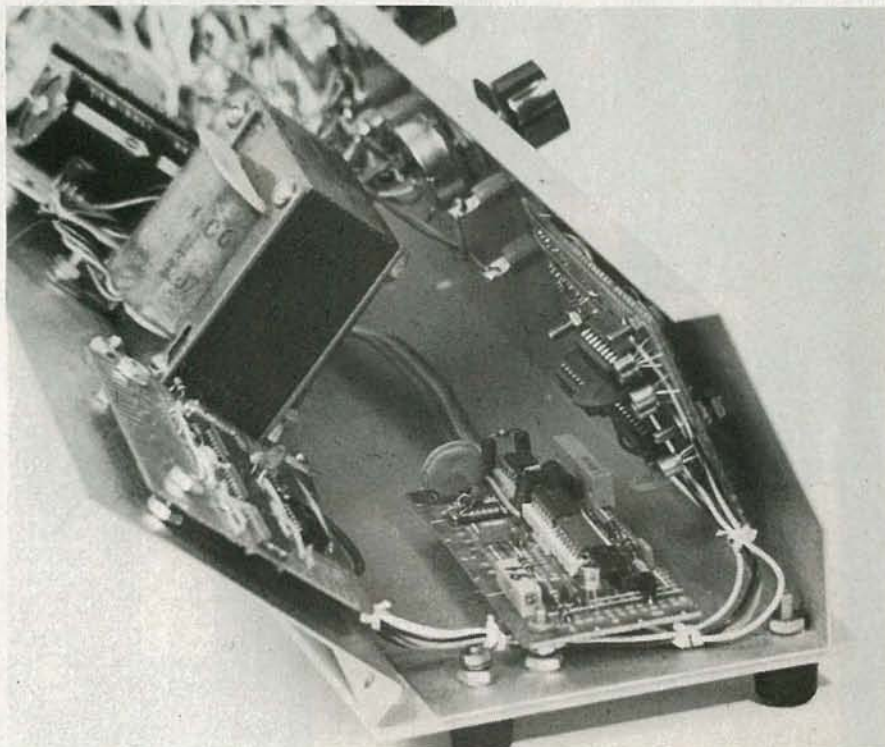

FIG. 9—DUAL-INPUT DVM was built in three sections to fit in tight cabinet. Timing logic is on left-hand board; amplifiers, switching, and V-F converter on center one, and display and display logic on front-panel-mounted board at right.

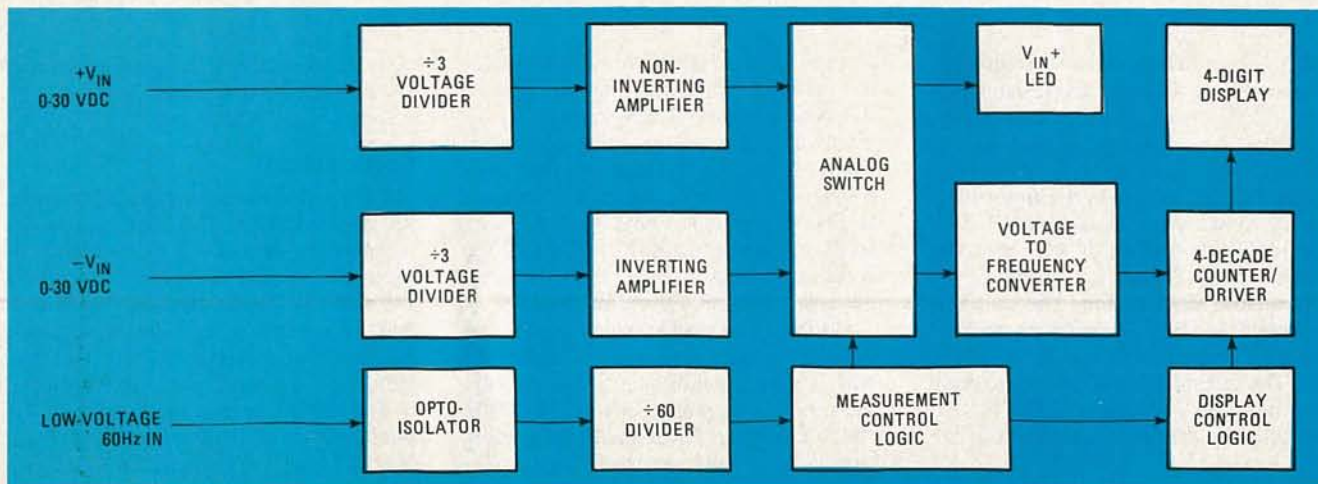

FIG. 10—BLOCK DIAGRAM of dual-input DVM. Timing and display circuits are essentially the same as those in general-purpose meter.

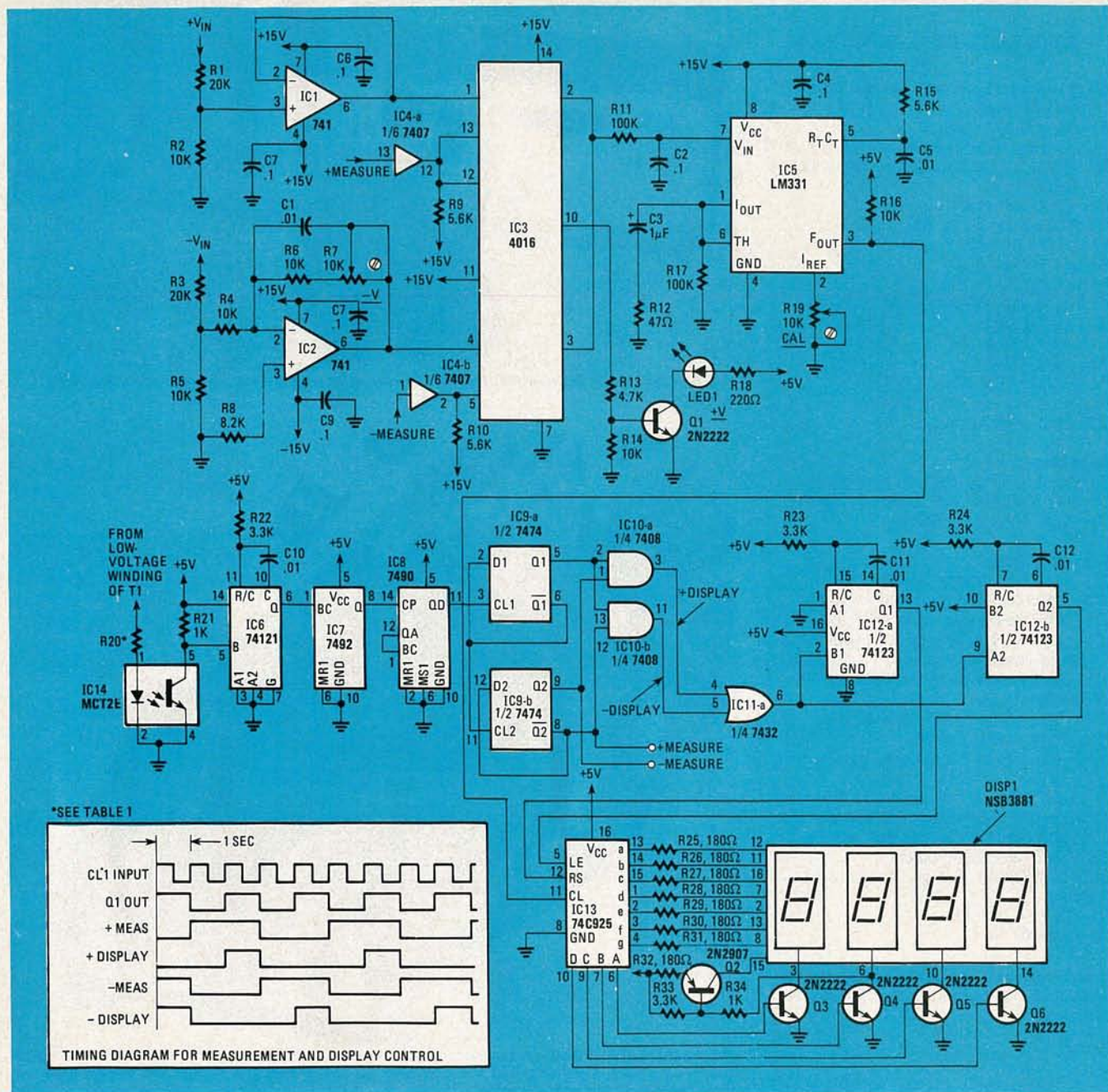
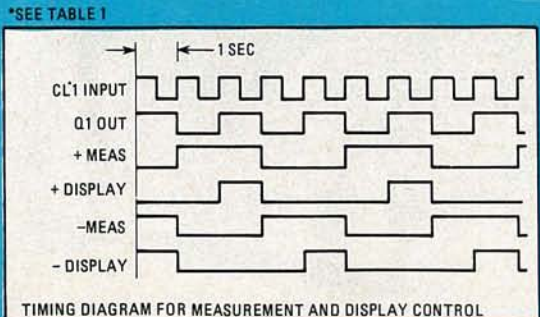

FIG. 11—UPPER SECTION of schematic of dual-input DVM shows input amplifiers, switching, polarity indicator, and V-F converter. Lower section shows timing and display circuits.



DVM requires a high input-resistance not necessary here, so I used less resistance in the divider, permitting use of the popular, low-cost 741 op-amp instead of the TL084C.

The TTL IC's used in the timer logic operate from 5 volts. A section of a 7407 open-collector buffer, IC4-a, provides translation to 15 volts for control of the 4016 quad CMOS switch. The switch is controlled by the + MEASURE and - MEASURE outputs of IC9-b, a 7474 flip-flop. The section of the 4016 used to drive the front-panel POLARITY LED is also controlled by the MEASURE output of the 7474.

A timing diagram is included in Fig. 11 as an aid in following the logic timing. A

complication arises in this DVM in that the voltage presented the voltage-to-frequency converter can change by as much as ten volts in going from one source to the other. There is a time constant in the V-F circuitry that will cause a large error unless it is dealt with. My way around that was to allow the LM331 two seconds of measure time, then take only the last half of that time for display.

While at first glance it may appear that the display logic is providing the counter with a simultaneous LATCH and RESET. That, however, really isn't so. The 7432 (IC11-a) triggers IC12-a with the leading edge of its output to reset only the counter (and not the latch) while the display continues to show the currently-latched

count. One second later, the trailing edge triggers IC12-b to latch the new count for display.

Construction

I tailored the construction of this meter to fit the location. The board at the rear (seen at the left in Fig. 9) contains the timing logic. The one in the middle holds the two 741's, the measure switching, and the V-F converter. The display logic and the display snuggle up to the front panel so the display can poke through.

The display is supported on the circuit board only by its wiring—short lengths of No. 22 bus wire (quarter-watt resistor leads). Each short piece of wire has a 90°

continued on page 99

ALL ABOUT

Part 2 IN THE FIRST ARTICLE of this series, we presented some of the fundamentals of active receiving antennas. That type of antenna has several advantages over wire antennas, especially at very-low and low frequencies (VLF and LF). First, active antennas have a short physical length. The active antenna systems that we will discuss here are used with a one-meter long whip. That helps reduce the sensitivity to local noise from sources such as power lines. Because of the active antenna's high input-impedance and low output-impedance, it is more efficient than a simple wire antenna in converting a received signal at the antenna to a corresponding voltage level at the receiver's antenna terminals.

In general, the properties that we want our active receiving antenna to have are: high input-impedance, low input-capacitance, low output-impedance, and minimum distortion/high linearity.

Another objective is to keep the circuit as simple as possible. A single-stage JFET amplifier has the best combination of properties for active antenna preamplifier applications—and it allows the circuit to be kept relatively simple. (This is not to suggest that there might not be better, more complex circuits, using several semiconductors or IC's.)

Wide-band amplifier circuit

The JFET that we have chosen to use is the Siliconix J-310 (or U-310 in metal can). That JFET is often used as a grounded-gate transmission-line amplifier for TV and FM reception (at a 75-ohm input/output level). The J-310 will usually handle short-duration static surges up to 100 volts or so without damage, so a

VLF Active Antennas

An active receiving antenna can dramatically improve your receiver's performance, especially at very low frequencies. Here we will discuss some practical circuits for both wideband and narrowband operation.

single low-capacitance neon bulb can provide input static-charge protection. That is of value since semiconductor diodes usually have a much higher junction-capacitance when used as protection devices and, if used, would increase the input capacitance of the preamplifier.

In our application as an active VLF-HF preamplifier, the J-310 is used in a common-source common-drain configuration with inductive feedback (that improves the linearity and lowers the output impedance). Figure 1 shows our wideband circuit for the range of 10 kHz to 30 MHz. Note that the feedback from drain to source is large because of the low resistance of the transformer and its 1:1 turns ratio. (We will discuss how to wind that transformer in Part 3 of this series; that part will contain actual construction details.) For the circuit to operate properly, the transformer's output should be opposite in phase to its input (with respect to ground).

The amplifier circuit is intended to be used with a 1-meter vertical whip. The antenna and its mount capacitances serve as part of an input filter. The input capacitance of the JFET is quite low (about 7 pF). The 2.2- μ H inductor at the gate of the JFET serves as a lowpass filter or trap, resonating with the junction and circuit (including antenna) capacitances at a frequency near 30 MHz. That input filter aids in reducing FM-VHF interference over a range of 50 to 500 MHz where the 1-meter whip acts like a resonant antenna.

Receiver coupler

The receiver coupler both provides power to the preamplifier and extracts the signal from the coaxial transmission line (from the preamp). A wideband receiver

R.W. BURHANS

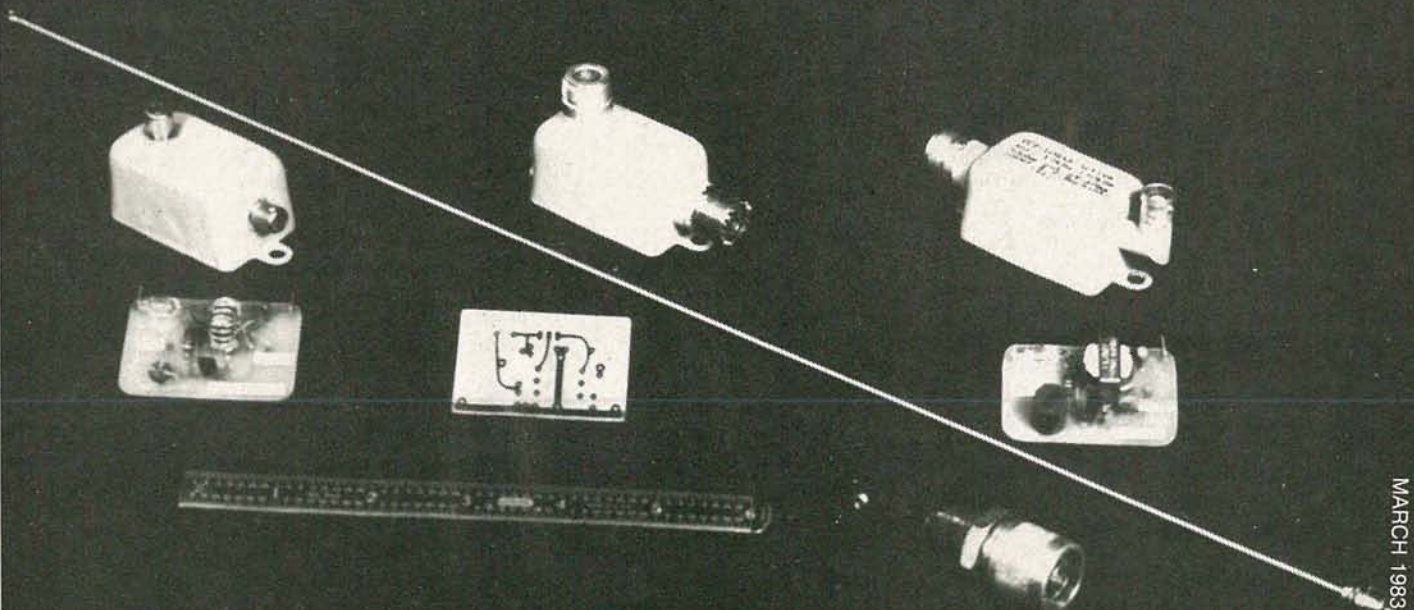

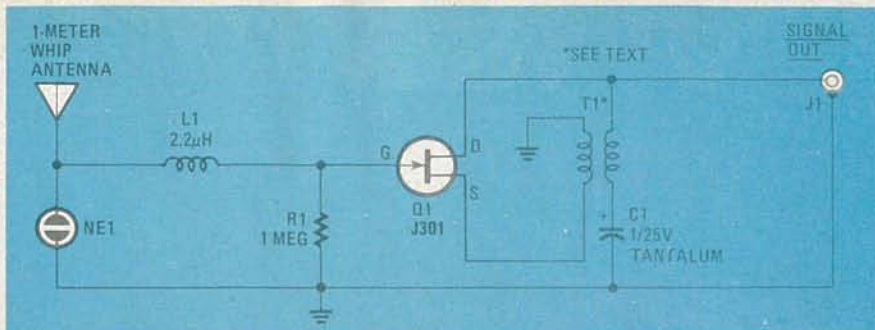

FIG. 1—THE WIDEBAND AMPLIFIER. The transformer should be connected so that the polarity of the output is opposite in phase to that of its input.

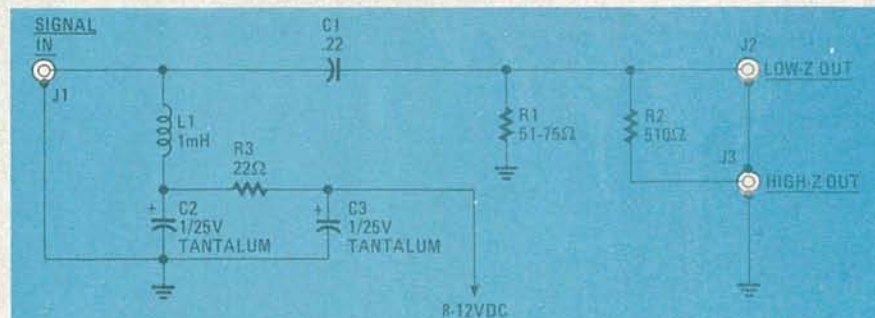

FIG. 2—THE RECEIVER COUPLER both provides power to, and extracts signals from, the amplifier, as well as acting as a highpass filter

coupler is shown in Fig. 2. Capacitor C1 and inductor L1 form a highpass L-section filter (with about a 10-kHz 3-dB rolloff). Resistor R1 is used to ensure that the preamplifier output sees a low-impedance load no matter what sort of receiver is connected. Resistor R2 is used for matching to a receiver with a higher input impedance. That resistor would cause a signal loss of 6 dB if the input impedance to the receiver were 500 ohms.

The coupler circuit provides DC power to the preamp through the coaxial cable. Power sources less than about +8 volts will reduce the dynamic range and linearity of the amplifier. The power dissipation of the JFET using a +8-volt supply will be about 200 mW. The rating of the J310 at 25°C is about 360 mW maximum. In practice, we have not burned one up even when operated with a +12 volt supply for an extended length of time.

The active antenna preamp is like a Class-A amplifier (where the output has low distortion, but the power furnished by the DC power supply is much greater than the power dissipated in the load). However, some distortion does ultimately appear in the output at high input-signal levels. That is due to the fact that a JFET biased in that way cannot be made perfectly linear over a wide dynamic swing of the output voltage. Other modes of operating the JFET with different biasing have been tried, but they have not resulted in any significantly better performance. So, in a sense, the circuits of Figs. 1 and 2 are of the "simpler is better" type.

Intermodulation distortion

A wideband active antenna covering

from 10 kHz to 30 MHz has poor performance with regard to IMD (*InterModulation Distortion*) because little input filtering is provided. Interference will be noted especially if the observer is close to strong AM broadcast-band transmitters. The standard method for evaluating the intermodulation response

of a receiver is to measure the 2nd and 3rd order intercepts.

Figure 3 shows a plot of the output power of the two fundamental signals (f_1 , f_2) versus the output power of the second order and third order distortion products. (We discussed intermodulation distortion products in the first part of this series, which appeared in the February issue of *Radio-Electronics*). Those are shown as a function of the power of a two-tone input signal.

One thing we should mention first is that when the input signals are too large, the amplifier output will not follow the input linearly. That is called *gain compression* and can be seen in Fig. 3.

If the linear portions of the curves are extended, they will eventually cross each other. That is shown in Fig. 3, where the curves are extended by dotted lines and cross at an output level that cannot be reached by the amplifier. The point where they cross is called the *amplifier intercept*. The input and output coordinates where they cross give you the input and the output intercepts.

In general, the higher the intercept point is on the graph, the better the amplifier's capability. Those measurements are best made with a sensitive spectrum analyzer, but an approximate idea can be obtained by using a receiver and recording the S-meter readings with appropriate signal-generator sources. The relatively low number of only +10 dBm for the 3rd order intercept indicates that the active antenna should be used

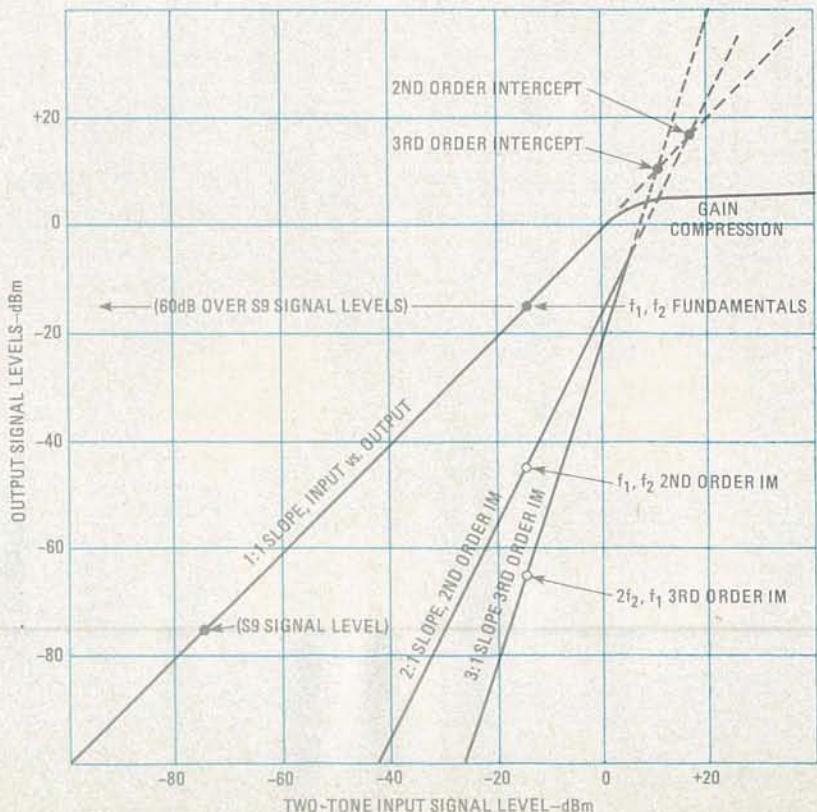

FIG. 3—THE HIGHER THE INTERCEPT POINTS, the better the amplifier's intermodulation rejection.

over a wide frequency range only where the local interference level is not severe. The antenna, of course, might be used in a high-signal area but the observer has to exercise some caution in making sure that the IM signals are not obscuring some desired signals on the same frequency.

For the wideband case of 10 kHz to 30 MHz, those intermodulation-distortion measurements suggest that only a short antenna of perhaps 1 meter or even less will provide the least amount of spurious responses—increasing the antenna length will only tend to increase the distortion level. Longer antennas should be used only when the active preamplifier is provided with some form of input and/or output filtering to reduce the out-of-band interference effects. With added input filtering, an active antenna with a 1-meter whip can provide less IMD because the input filter reduces the likely interfering signals before they have a chance to operate on the preamp input circuitry.

Although the wideband active antenna should not be used with anything longer than a 1-meter whip in areas of high adjacent-channel interference, longer antennas—perhaps up to 10 meters—can be tried in a "quiet" location for operating in the VLF-LF range. However, when using long antennas in the HF region there is an additional interference problem because the antenna is resonant at more than one frequency. One rule to follow here is to keep the length of the antenna less than $\frac{1}{10}$ wavelength at the highest frequency used for a wideband system. Although that is short at the highest frequency, an

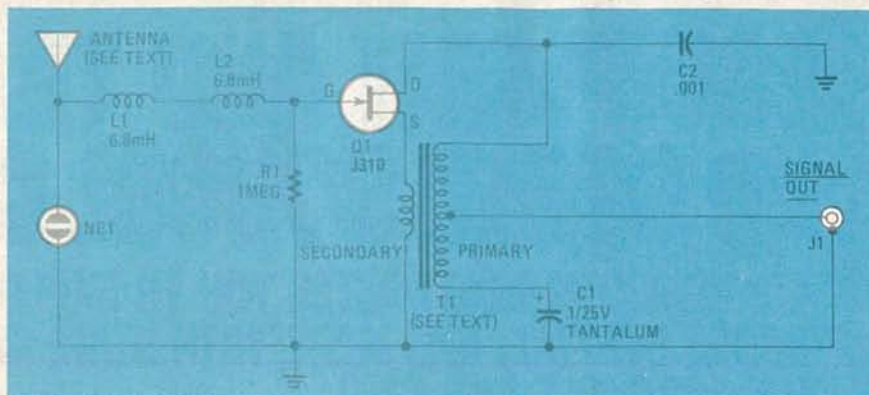

FIG. 4—THE INPUT INDUCTORS and circuit capacitance form a lowpass filter that makes this an amplifier for restricted use in the VLF-LF range.

antenna of that length used with the wideband preamp will perform almost as well as a 48-inch top-loaded vertical connected to a 50-ohm system (as in mobile CB radios at the 27-MHz region). A primary reason for using an active-antenna system is to provide good performance over a wide range with small physical size. Thus, if the antenna is to be used only for the CB range, it would be simpler to use an ordinary CB antenna and avoid all of the wideband problems.

Amplifier circuit—VLF and LF

At frequencies below about 500 kHz, the amplifier circuit is modified to provide input filtering and higher voltage-gain. Figure 4 shows the modified circuit. Two input inductors and the circuit capacitances form a lowpass filter with a cutoff frequency near 450 kHz (see Fig.

5-a). The choice of those inductors is somewhat critical because the preamp's operation depends partly on the resonant frequency of the coils, the distributed capacitance, and the capacitance of the windings to the shield housing. To reduce mutual coupling, the coils are connected in series with their windings opposing each other. Therefore, they still can be mounted close together on a small circuit board with no interstage shield. That arrangement provides at least another 30 dB of attenuation for broadcast-band signals directly at the input to the preamplifier where the problem of intermodulation starts. A single inductor can be used, but it will not provide quite as sharp a cutoff for interference from the AM broadcast band.

The output transformer is an ultra-miniature audio-output transformer with a 200-ohm center-tapped primary and an 8-ohm center-tapped secondary. (We will talk more about that transformer when the series continues.) The output transformer has good response to at least 400 kHz, even though it was originally intended for audio-frequency use. The smaller amount of feedback applied from drain-to-source results in higher voltage gain of about +6 dB at the expense of slightly less power gain, or a higher output impedance when compared to the 1:1 wideband toroid. However, we use the iron core transformer because of its low cost as well as the lowpass output filtering provided.

When used with a 1-meter whip, the VLF-LF version of the active antenna—with an input lowpass filter with about a 450 KHz rolloff—provides higher intercept points with respect to broadcast-band interference (although it is about the same for interference from other frequencies). If you are located in a region free from high-power broadcast-band transmitters, then you can use the preamplifier of Fig. 4 with longer antennas. However, a point is reached with any active system where merely increasing the antenna size does not improve the overall signal-to-noise ratio because the atmospheric noise level increases at the same rate as the signal.

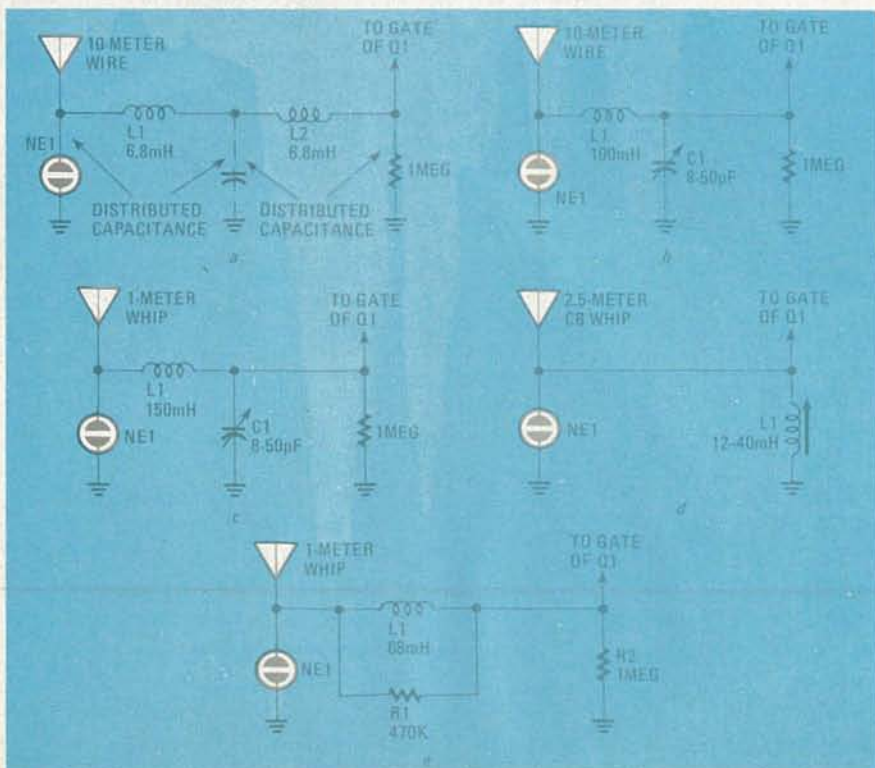

FIG. 5—VARIOUS INPUT NETWORKS for VLF-LF operation can improve performance at particular frequencies or increase the antenna's selectivity.

EQUIPMENT AND TRAINING NO OTHER SCHOOL CAN MATCH.

**NTS HOME TRAINING INVITES YOU TO EXPLORE MICROCOMPUTERS,
DIGITAL SYSTEMS AND MORE, WITH STATE-OF-THE-ART EQUIPMENT
YOU ASSEMBLE AND KEEP.**

Without question, microcomputers are the state of the art in electronics. And NTS is the only home study school that offers you training for this booming field with a choice of 3 production-model micro computers.

We'll explain the principles of troubleshooting and testing your microcomputer and, best of all, we'll show you how to program it to do what you want.

You'll use a digital multimeter, a digital logic probe and other sophisticated testing gear to learn how to localize problems and solve them.

Send for the full color catalog in the electronics area of your choice—discover *all* the advantages of home study with NTS!

NTS also offers courses in Auto Mechanics, Air Conditioning and Home Appliances. Check card for more information.

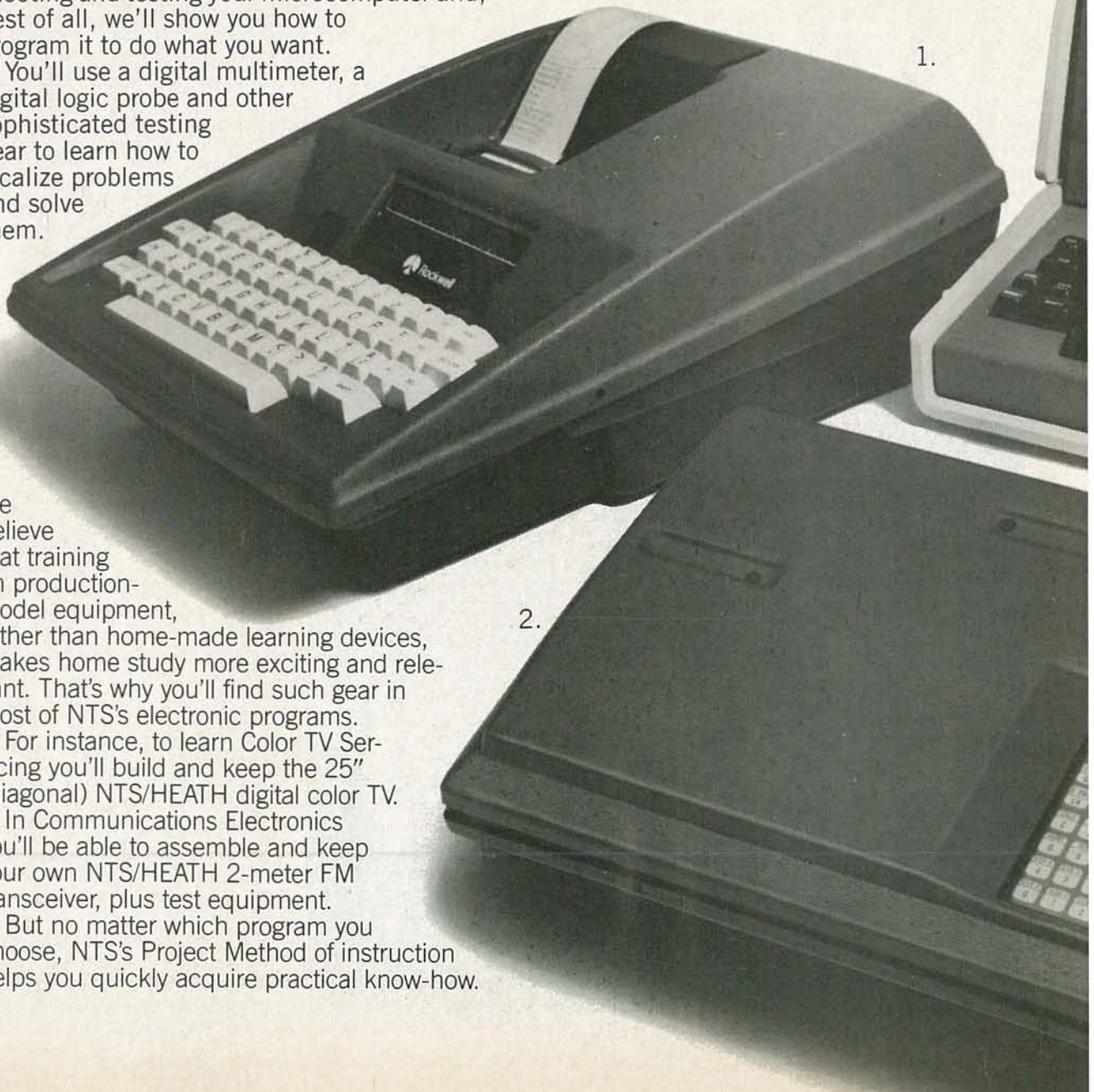

We believe that training on production-model equipment, rather than home-made learning devices, makes home study more exciting and relevant. That's why you'll find such gear in most of NTS's electronic programs.

For instance, to learn Color TV Servicing you'll build and keep the 25" (diagonal) NTS/HEATH digital color TV.

In Communications Electronics you'll be able to assemble and keep your own NTS/HEATH 2-meter FM transceiver, plus test equipment.

But no matter which program you choose, NTS's Project Method of instruction helps you quickly acquire practical know-how.



Simulated TV Reception

1. The NTS/Rockwell AIM 65 Dedicated Microcomputer A Single board unit featuring on board printer and display—4K RAM (expandable). Application Functions: Central processor—Controller/Monitor—Development System. 2. "The NTS/SYM-1 Microcomputer" 6502 Based CPU—4K bytes ROM (expandable)—1K RAM (expandable). 51 active I/O lines for versatile interfacing: disk drives, ASCII key boards, cassette tape, etc.

3. The NTS/Heath HN-89A Microcomputer features floppy disk storage, "smart" video terminal, two Z80 microprocessors, with 32K RAM Memory, expandable to 64K on board. 4. The NTS/Heath GR 2001 Digital Color TV (25" diagonal) features specialized AGC-SYNC muting, filtered color and new solid-state high voltage tripler rectifier.

NTS NATIONAL TECHNICAL SCHOOLS

TECHNICAL-TRADE TRAINING SINCE 1905
Resident and Home-Study Schools
4000 SO. FIGUEROA ST., LOS ANGELES, CA. 90037



NATIONAL TECHNICAL SCHOOLS
4000 South Figueroa Street, Dept. 206-033
Los Angeles, California 90037

Please rush FREE color catalog on course checked below

| | |
|---|---|
| <input type="checkbox"/> MicroComputers/MicroProcessors | <input type="checkbox"/> Auto Mechanics |
| <input type="checkbox"/> Communications Electronics | <input type="checkbox"/> Air Conditioning |
| <input type="checkbox"/> Digital Electronics | <input type="checkbox"/> Home Appliances |
| <input type="checkbox"/> Industrial Technology | <input type="checkbox"/> Color TV Servicing |

Name _____ Age _____
Address _____
Apt. _____ City _____
State _____ Zip _____

Check if interested in G.I. information.
 Check if interested ONLY in classroom training in Los Angeles.

Resonant input circuit

Figure 5 illustrates various high-impedance input networks for restricted use in the VLF-LF region (such as Loran-C only, or WWVB, or for the 160 kHz-190 kHz experimenters' license-free band). A series inductor with a small input tuning capacitor can be used to further reduce interference and increase the antenna performance. A miniature trimmer-capacitor with a tuning range of 8 to 50 pf placed from the gate to ground, directly across the 1 megohm input resistor (see Figs. 5-b and 5-c) provides a means of tuning the series inductor for a peak at the desired frequency range. The result is a sharp, high-frequency cutoff with a more gradual low-frequency rolloff. The inductor was chosen to be self-resonant (remember, real inductors also have capacitance) at a somewhat higher frequency than the top of the desired tuning range. That technique will work for some pot-core or slug-wound inductors but will usually not work well with large toroids, as they have too much distributed capacitance at VLF. It is also possible to shunt a slug-tuned inductor from the gate to ground (as in Fig. 5-c) but the preamp will then require a larger housing. For that parallel-tuned case, the 1-megohm resistor can be removed because the inductor provides the ground return for the gate. The antenna is then connected directly to the gate terminal with the inductor chosen to resonate with the antenna, input-circuit, and antenna-mount capacitances. The minimum of external tuning capacitance provides the highest Q (most selective) antenna in this application. For DX hunting in the low-frequency experimenters' band (at 180 kHz), a narrowband antenna with a Q of more than 50 can be achieved with a parallel-tuned circuit.

One problem with using a tuned circuit is that it restricts the remote applications of the active antenna. That is because the antenna must be located conveniently so that it can be returned. However, for covering some fixed frequency (such as

the experimenters' band) the antenna system can be aligned on the bench and then mounted for unattended operation. When tuning those systems, it is advisable to temporarily mount the preamplifier assembly in a fairly clear area (preferably where it will be permanently located) to avoid nearby capacitive coupling, which might detune a very selective system.

One technique for broadbanding a tuned circuit is to place a resistor in parallel with the inductor (See Fig. 5-d). Resistor values in the range of 50K to 500K ohms can help broaden Loran-C systems where a wide bandwidth is necessary.

Traps

Series-connected transmission-line traps tuned to local broadcast-band stations and placed just ahead of the receiver coupler can improve the IMD somewhat and reduce overload or gain-compression problems (see Fig. 6). The tuning capacitors must be isolated from ground and the inductor must be chosen so as to have a reactance greater than 50 ohms at the desired notch frequency. Dual traps are possible. For example, Fig. 6 shows a trap for 970 kHz and another for 1340 kHz connected in series. The combination of input lowpass filters at the antenna and traps at the preamp output can usually provide sufficient attenuation for cases of severe interference in the VLF-LF band from stations in the broadcast band.

A summary of some measurements made with different antennas at 60 kHz for WWVB reception is shown in Table 1. It should be noted that a 2-meter vertical whip is about equivalent in sensitivity to the much larger flat-top antenna. However, the flat top is much more susceptible to noise and interference, even when it is operated with a lowpass filter at the preamp input. The effective-height estimate may not be the same over the entire frequency range. For example, the flat top appears to have an effective height of about 2 meters at 200 kHz but less than 0.9 meters at 60 kHz. That is because of

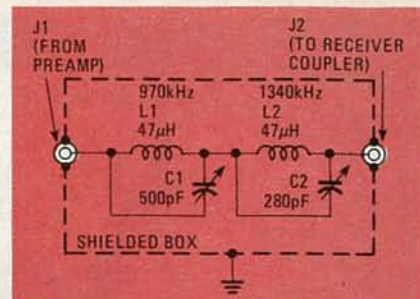

FIG. 6—TRAPS CAN BE USED to reduce interference from broadcast band stations—in this case from stations at 970 and 1340 kHz.

K—the shielding effect and conductivity of the local ground terrain, which includes all the trees, power lines, and building structures. However, we are still able to operate the antenna even down to the 10.2 kHz Omega frequency with reasonable success and it is used routinely to check GBR on 16 kHz for VLF propagation conditions. (GBR is a high-power military VLF station from Great Britain.) In practice, it is always wise to check for IM effects at the specific frequency range that you plan to use the antenna. Sometimes they are severe but only at relatively narrow frequency ranges usually not in the VLF range.

For general wideband surveillance, the 1-meter whip with an effective height of about 30 cm is the best antenna of all, because it has fewer IM interference effects and less local noise from the power lines.

A general conclusion from all of the experiments is that the local environment and the ground-conductivity effects of nearby structures are the most important factors in determining antenna sensitivity. Small changes in antenna location can produce remarkable differences in the antenna's performance.

Another observation is that the best location for a short whip is invariably up high in the clear. (That can especially be seen in aircraft applications where a very short vertical whip is used with remarkably good performance.)

Low-frequency experimental radio station operators have reported good results in mobile operation with reception of 160 to 190 kHz signals using 2.5-meter CB whips and parallel-tuned input networks. We have conducted similar experiments with Omega and Loran-C receivers in mobile vehicles where the only problems were those of shielding from buildings or when driving under bridges or near power lines. An additional problem in mobile operations is harmonic radiation from the vehicle's AC alternators.

When we continue this series, we will discuss construction details and include printed-circuit board layouts for the active antenna preamplifier and receiver coupler. We will also discuss how to bench test the preamp, and how to mount the system.

R-E

TABLE 1

| Parameter | | Whip 1 | Whip 2 | Flat Top |
|--|----------------------------|-------------------|-------------------|-------------------|
| Physical Height | (h_m) | 1m | 2m | 10m |
| Antenna Capacitance | (C_a) | 10pF | 20pF | 118pF |
| Fixed Capacitance | ($C_m + C_g$) | 15pF | 15pF | 15pF |
| Voltage Gain at Preamp | (A_v) | 1 (0dB) | 1 (0dB) | 2 (+6dB) |
| Estimated Ground Coupling Effect | (K) | 0.7 | 0.7 | 0.05 |
| Effective Height | (h_e) | 0.28m | 0.80m | 0.88m |
| WWVB Reading on YAESU FRG-7700 | | S6 | S9 | S9+ |
| Estimated E-field for WWVB (from NBS chart) | (E_i) | 150 μ V-per-m | 150 μ V-per-m | 150 μ V-per-m |
| Output S+N for (60kHz WWVB at Preamp) | ($E_o = E_i \times h_e$) | 42 μ V | 120 μ V | 132 μ V |
| Estimated (S+N)/N during 60 Hz "quiet hours" | | +10dB | +20dB | +20dB |
| Overall Noise Rating | | good | fair | poor |
| IM Distortion Rating | | fair | poor | very poor |

How to Design Analog Circuits Audio Power Amplifiers

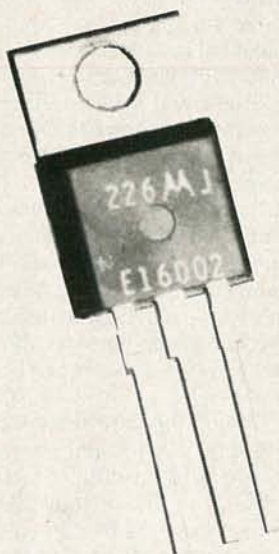

MANNIE HOROWITZ

Here's a look at some practical audio power-amplifier circuits. Circuits using both bipolar and FET devices will be covered.

ALTHOUGH IN THE PAST MANY PIECES OF audio equipment used transformers to couple the driver stage to the power transistors, and those transistors to the loudspeaker, output transformers are currently used only in equipment providing very low output power. You are likely to find an output transformer in a portable radio, but in little else. As for sophisticated equipment, economy may dictate that a driver transformer be used, but output transformers are usually avoided because they may severely limit the fidelity of the signal delivered to the loudspeaker. Instead, most modern audio equipment uses one of a variety of types of transformerless circuits to drive the power-amplifier stages.

Transformerless amplifiers have in the past mainly used bipolar power-transistors. The present trend, however, is to use power VFET's and MOSFET's. One reason for that is the absence of problems such as thermal runaway and second breakdown inherent in bipolar transistors. Another important reason is that FET characteristics are more linear than those of their bipolar counterparts. Consequently, when amplifiers using FET's as output devices are compared with those

using bipolar transistors, the distortion is lower in the FET circuits. As a result, you need less feedback to reduce distortion to near ideal levels with FET amplifiers than you would in bipolar amplifiers. And, because less feedback is required in FET amplifiers, instability problems due to feedback are less.

Driver transformer circuits

A circuit using a driver transformer is shown in Fig. 1. The input signal is fed to the base of Q1 and amplified. The amplified output appears across the primary winding (winding 1) of the driver transformer, T1. The signal from that winding is induced into the two secondary windings and applied from there to output transistors Q2 and Q3. Note that in Fig. 1 there is a dot shown at one end of each secondary. Those dots indicate which ends of the various windings are in phase. While a signal is applied to the base of output transistor Q3 from the end of winding 3 with the dot, a signal of the opposite phase is applied from winding 2 to the base of Q2 from the terminal without the dot—in other words, the same signal is applied out of phase to the two output transistors. If the transistors were biased

so that they did not conduct when idling, each transistor would conduct only when a signal was present—in this case only during alternate halves of the cycle. The outputs from Q2 and Q3 will then combine across the loudspeaker load to reproduce the original signal.

Transistors are not biased for zero idling current. There is always some current flowing so that the output devices operate in Class-AB. Bias current for Q2 flows through R3 and through winding 2 of the transformer to the base. Although some of the current from R3 is diverted through R4, there is sufficient current left for the base of Q2 to keep it turned on while idling. A similar arrangement involving R5 and R6 keeps Q3 turned on.

Resistors R7 and R8 in the emitter circuits of Q2 and Q3 respectively are not used exclusively in circuits with driver transformers. They are frequently found in completely transformerless circuits. Those emitter resistors increase the voltage gain of the driver stage while significantly reducing the voltage gain of the output devices. To minimize that loss of gain, the values of the resistors are kept small, and the circuit is designed so that between 0.5 and 1 volt is across each of

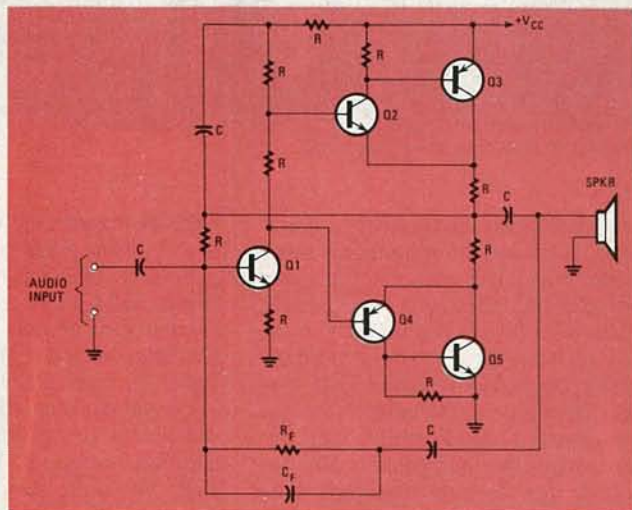

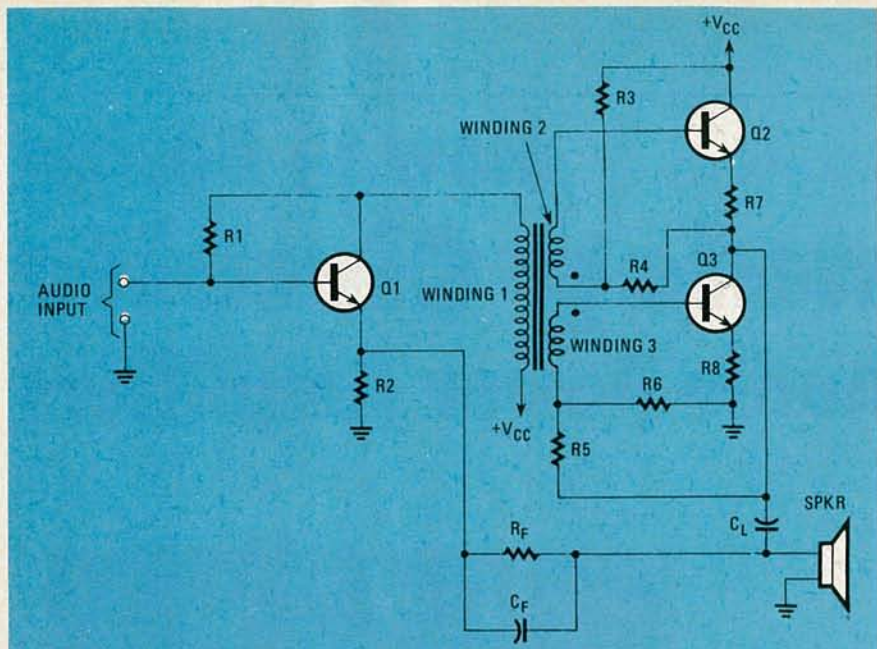

FIG. 1—POWER AMPLIFIER with driver transformer. The outputs from Q2 and Q3 recombine across the speaker to reproduce the input signal

the resistors when the transistors idle.

As is true with just about every other transistor circuit using a resistor in series with the emitter, resistors R7 and R8 help to stabilize both AC gain and DC bias. Those resistors also serve as output-transistor protection devices. That protection is important because an output transistor may break down if a short develops across the loudspeaker. But the protection that those resistors provide is somewhat limited; more complex feedback circuits do a better job.

In Class-AB push-pull amplifiers, during different portions of the cycle either one transistor or the other conducts more heavily. During one half cycle, Q2 may conduct heavily and Q3 may not conduct at all, while in the other half the situation may be reversed. In each cycle, however, both transistors must change from a conducting to a non-conducting state and vice versa. Resistors R7 and R8 help to make that transition smooth, keeping crossover distortion to a minimum. To really improve the smoothness of the transitions, diodes can be substituted for the emitter resistors.

Driver transistor Q1 supplies the bulk of the voltage gain for the circuit while providing sufficient power to drive output transistors Q2 and Q3 through the transformer. The turns ratio of the transformer is selected for minimum distortion across the output load, and is found by trial and error. Typically, however, the turns ratio is usually about 1.7:1. If transformers are not readily available for substitution into the circuit, you will have to live with what you do have but add a feedback circuit to reduce distortion to reasonable levels.

Let's now see how feedback can be used to reduce distortion. The signal is

fed back from the output to Q1 through R_F and C_F . If the phase is proper, the voltage gain of the circuit is reduced when those components are connected as shown. (Should gain increase or should the circuit oscillate, improper phasing is usually at fault. To correct that situation, just reverse the connections to the primary of the driver transformer.) The network adds what is referred to as negative feedback. When the gain is reduced so is the distortion. If gain is reduced too much, however, the circuit may oscillate. You can determine the amount of usable feedback by trial and error—by varying both R_F and C_F .

A circuit may become marginally unstable even when negative feedback is added. That is because feedback may be negative within a specific frequency range (the range in which the quantity of feedback is being measured) but become positive outside of that range. A square-wave generator and an oscilloscope can be used to check the stability of an amplifier with feedback. Start by feeding a 10-kHz squarewave to the input of the

amplifier. Note the waveform across the amplifier's output—it should be reasonably square. The three displays that you are most likely to see are shown in Fig. 2. In Fig. 2-a, the ringing on the top and bottom of the squarewave tends to rise with time while in Fig. 2-b it decreases. In Fig. 2-c, there is no ringing, but the leading edge of the squarewave is rounded.

When the output is as shown in Fig. 2-a, the circuit has a tendency to oscillate. That is indicated by the rising amplitude of the ringing signal. Even though the signal in Fig. 2-b also shows ringing, it is more stable because the ringing decreases with time and tends to disappear. To go from the state shown in Fig. 2-a to the one shown in Fig. 2-b usually involves simply increasing the value of C_F . If, however, C_F is made too large, ringing may be eliminated but the leading edge of the squarewave will become rounded as shown in Fig. 2-c. If that happens, there may be a loss of high frequency response. The best compromise to adjust C_F so that the waveform is somewhere between those shown in Figs. 2-b and 2-c.

Do not disregard the information presented here concerning the proper design of transformer-coupled circuits with feedback. You may think that it does not apply when no transformer is used, but that is not true. The information presented here applies to all types of power amplifiers. As for feedback, the details and characteristics will be covered in a later article in this series.

Amplifiers using a complementary circuit

For best results from a push-pull circuit, the two halves of the output circuit must be identical. That is not the case in the circuit shown in Fig. 1. There, the output from Q2 is taken from its emitter while the output from the Q3 is taken from its collector. Consider, on the other hand, the circuit shown in Fig. 3. In that transformerless circuit, transistors Q2 and Q3 (NPN) and transistors Q4 and Q5 (PNP) form two darlington pairs.

The loudspeaker load is fed by one Darlington pair during the first half of the cycle, and the other one during the second so that the output signal is perfectly

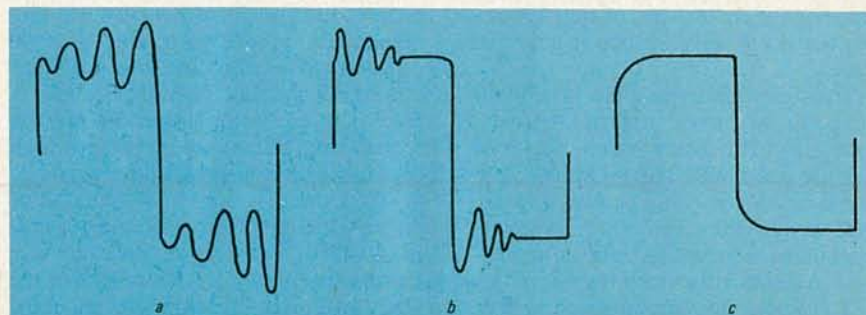

FIG. 2—IF A SQUAREWAVE is applied to the input of an amplifier, the waveforms shown here may be observed at the output. The waveforms in a and b indicate oscillation (ringing); the one in c indicates loss of high-frequency response. All of those conditions can be changed by changing the value of C_F

balanced. The input signal is applied to the voltage amplifier, Q1. Its amplified output is applied, in phase, to both Q2 and Q4. That phase relationship is necessary for Q2 to conduct on positive halves of the cycle and Q4 on negative halves. This same phase relationship exists at the outputs from Q3 and Q5. Those outputs are recombined across the loudspeaker to reproduce the full cycle.

Some idling current must flow in the output transistors, just as it did in the circuit in Fig. 1. The amount of idling current is established by the voltage developed across R3. That voltage, when applied to the bases of Q2 and Q4, produces a current through the base-emitter circuits of those transistors. Emitter currents from Q2 and Q4 set the base currents and hence idling emitter currents of Q3 and Q5. In most instances, R3 is replaced by forward-biased diodes, or a series resistor-diode combination, to stabilize idling current despite temperature variations.

But how is a voltage developed across R3? (That is one of the load resistors in the collector circuit of Q1.) The others, wired in series with R3, are R4 and R5. When collector current flows through Q1, the voltage required to forward bias Q2 and Q4 is developed across R3. Transistor Q1 is biased through resistor R1, which is connected to the junction of R8 and R9. When idling, the voltage at that junction is ideally $\frac{1}{2}$ of $+V_{CC}$. Resistor R1 is connected to that point to help stabilize the bias of Q1 against temperature variations.

In order to minimize distortion, a considerable amount of negative feedback must be used around the circuit. If a lot of feedback is applied, however, the gain will drop to low levels. To compensate for that, the forward gain of Q1 must be made very high. Capacitor C_B helps the circuit meet that gain requirement. Signal is fed back through C_B from the output to the junction of R4 and R5. That is known as a "bootstrapping" circuit. That bootstrap circuit makes R4 appear to be much larger than it actually is. And, as R4 is part of the collector load-resistance, the forward gain of Q1 is very high because it is approximately equal to the ratio of the resistance in its collector to the resistance in its emitter.

Capacitor C_B also serves a more important purpose. When the signal is large, the emitter of Q2 is at $+V_{CC}$ volts. When that happens, no current can now flow through its base-emitter junction because the emitter is more positive than the base and Q2 does not conduct. Peaks in the signals are consequently cut-off causing distortion. Let's see how including C_B in the circuit corrects that situation. That capacitor is charged to about $\frac{1}{4}$ of $+V_{CC}$ when the circuit is idling. When a peak is present in the signal, not only is the emitter of Q2 at $+V_{CC}$, but since the bottom of C_B is effectively at the same potential

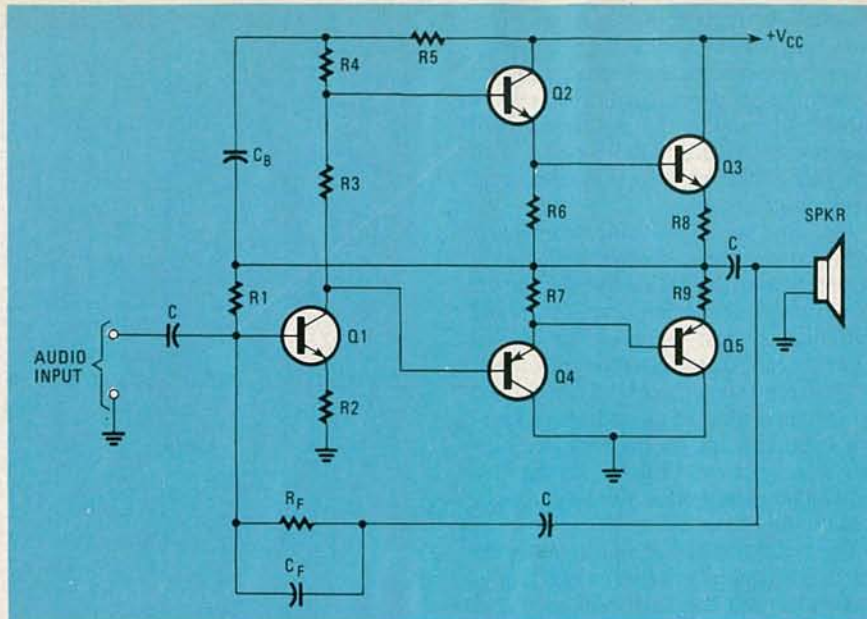

FIG. 3—DARLINGTON PAIRS are used in the output circuit of this audio power-amplifier.

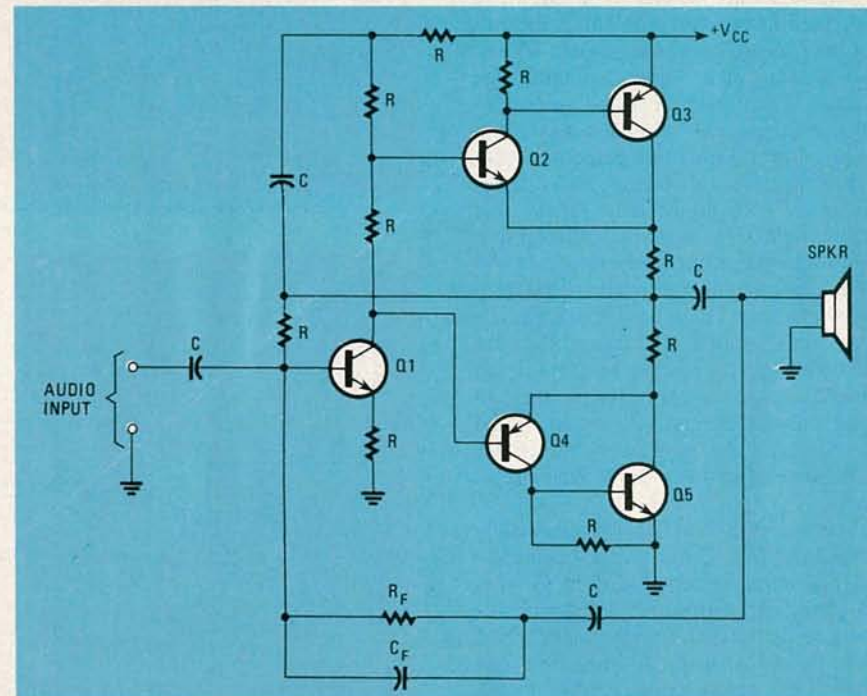

FIG. 4—COMPLEMENTARY PAIRS are used in the output circuit of this amplifier. The signals from them combine across the speaker to reproduce the input signal.

as the emitter, that terminal of the capacitor is also at $+V_{CC}$. Because the capacitor is charged to about $\frac{1}{4}$ of $+V_{CC}$, the top terminal of C_B is at $+V_{CC} + V_{CC}/4$. That voltage is applied to R4 to make the base of Q2 positive with respect to its emitter, turning Q2 on. Being turned on, peak positive pulses can now pass through Q2, and the balance of the circuit, to the loudspeaker.

When the circuit is idling, C_B does not affect the performance of the amplifier. Resistors R4 and R5 are chosen so that base current in Q2 and Q4 is proper for the desired idling current to flow through the output transistors. The values of R4 and R5 are usually identical. As before, R_F and C_F form the negative feedback cir-

cuit. The method used to find the values for those components are identical to the one previously discussed.

Complementary circuits can be used in place of the Darlington pairs in the power-output circuit. The complementary pair was described in the article on coupled circuits. A circuit using complementary pairs is shown in Fig. 4. Here, Q1 performs the same function as it did in the circuit shown in Fig. 3. Transistors Q2 and Q3 form one complementary pair; transistors Q4 and Q5 form a second.

One of the big drawbacks of the two transformerless circuits discussed thus far is the presence of a capacitor between the output circuit and the loudspeaker. That capacitor must have a high value if it is to

pass the low frequencies. Since the capacitor gets charged through the output transistors, and since the initial charge current is very large, more current may flow through Q3 and/or Q5 at that moment than can be handled safely. Because of that, one or both of those transistors may break down.

A second drawback using that capacitor is that it is almost always an electrolytic because of the high values required. An electrolytic capacitor is not linear, and consequently just the presence of that capacitor can add to distortion somewhat.

The circuit shown in Fig. 5 can be used to overcome some of those drawbacks by simply eliminating the need for a capacitor. Arrangements similar to the one shown there are used in some very high-quality amplifiers.

The big problem in amplifiers that do not use a capacitor between the output transistors and the loudspeaker is that there is no way of keeping DC from flowing through the speaker. The circuit in Fig. 5 eliminates that problem. If the output devices are connected to equal positive and negative voltage supplies, the voltage at the junction of the output devices is zero. That assumes that equal idling current flows through the two complementary pairs of transistors. Current can usually be adjusted to satisfy that requirement. However that relationship will hold only at one temperature; it will not when the temperature rises or falls in the preceding DC-coupled stages. To overcome that, differential amplifiers are used to drive the output stages—if the current changes in one of the devices, an equal current change will occur in the second device, keeping the overall circuit in balance. Let's see how that circuit works.

Transistors Q1 and Q2 form one differential amplifier. They drive a second differential amplifier consisting of Q3 and Q4. The output from Q3 is applied directly to the Q6/Q7 complementary pair while the signal from Q4 must first pass through Q5 before being applied to the Q8/Q9 complementary pair. Transistor Q5 is required because it shifts the phase of the signal from Q4 so that the signal fed to Q6 is in phase with that at the input of Q8. Resistors in the base and emitter circuits of Q5 are adjusted so that the current from Q5 is equal to the current from Q3. No bootstrap capacitor is required in that circuit as the proper current levels are always present at Q6 and Q8, through Q3 and Q5 respectively.

Potentiometer R1 is adjusted so that there is 0 volt at the junction of Q7 and Q8, and across the loudspeaker. Transistor Q10 is in a constant current source circuit, required for proper operation of the differential amplifier.

The circuit shown in Fig. 6 is similar to the one in Fig. 5. The op-amp, as discussed in a previous article, is actually a combination of differential amplifiers.

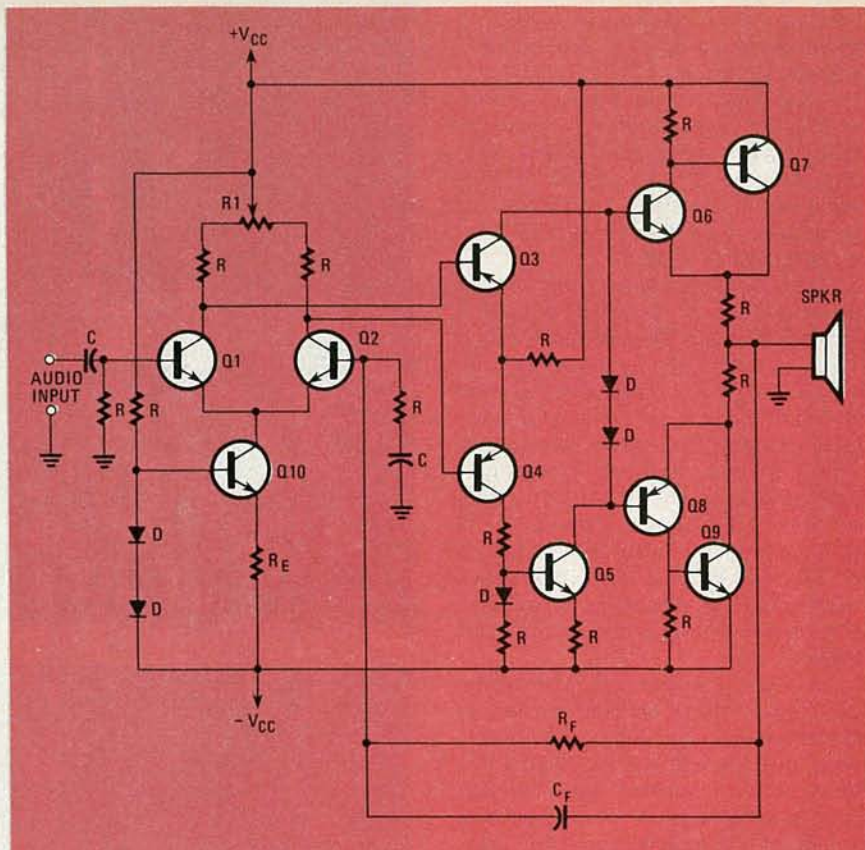

FIG. 5—THE HEART OF THIS high-quality circuit is a pair of differential amplifiers.

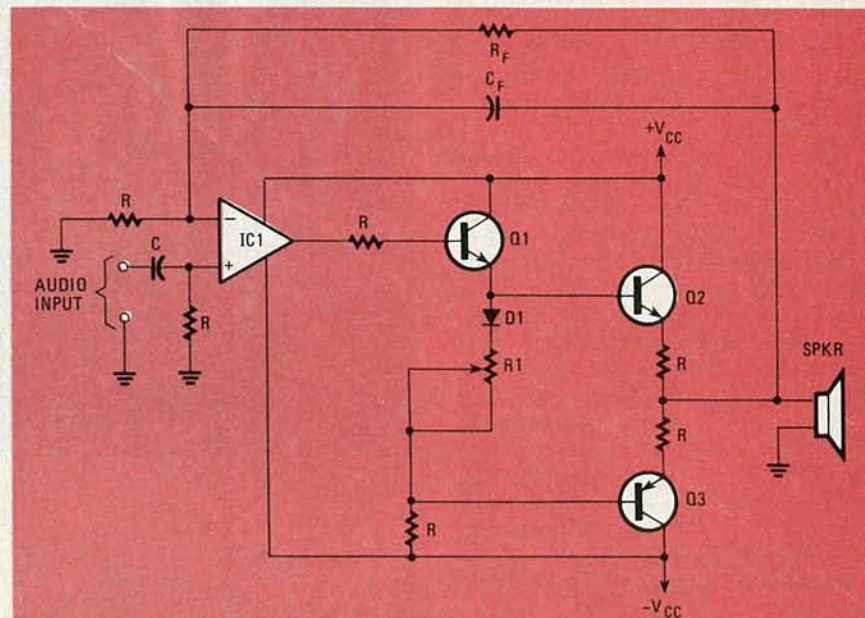

FIG. 6—SINCE OP-AMPS are simply combinations of differential amplifiers, they can be used in this variation of the circuit shown in Fig. 5.

As such, its DC-output level is extremely stable despite temperature changes. Because that stable voltage is coupled to the output devices, a loudspeaker can be connected directly to those output transistors without an intervening capacitor.

Note two items peculiar to this circuit. Instead of using Darlington or complementary pairs in the output, a single output transistor is used in each leg of the push-pull circuit. Second, the voltage de-

veloped across D1 and R1 is used to establish the bias for Q2 and Q3. The desirable idling current for the output transistors is set by adjusting R1 because that potentiometer varies the voltage applied to the base circuits. Diode D1 helps keep that voltage, and hence the idling current, constant despite variations in temperature.

Next month we'll continue our discussion of power amplifiers.

R-E

ADVANCED ELECTRONICS IS PROUD TO INTRODUCE THE A.W. SPERRY INSTRUMENTS LINE OF TEST EQUIPMENT.

15 MHz DUAL TRACE PORTABLE W/INTERNAL BATTERY PAK



MODEL
315P

**THE SMALL PORTABLE
WITH BIG FEATURES**

FEATURES

- AC/DC powered • 2mV/Vertical sensitivity • TV (Video) sync filter • 3¼" internal graticule, high brightness CRT • X-Y display mode • Add/Sub mode with ch.2 invert • Automatic and triggered time base • Trace rotation adjustable from front panel • Internal rechargeable pak included • Lightweight 12.1 lbs with battery • Small size (4.4" x 8.8" x 11.7")

SPECIFICATIONS

Vertical System CH. A and CH. B-Deflection Factor, 2mV/div - 10V/div, 12 steps • Frequency Response, DC - 15 MHz (-3 dB) • Risettime, 24 ns • Maximum Input Voltage, 300 V (DC + AC peak) • Input Impedance, 1MΩ ± 5%, 20pF ± 3pF • Display Modes, CH-A, CH-B, DUAL, ADD, CHOP • Internal Horizontal System (Sweep Operation) • Deflection Factor, 0.5μs/div. - 0.5s/div (±5%), 19 steps • Magnification, 5x all ranges • Trigger System - Sources, INT, CH-A, CH-B, EXT • Modes, AUTO, NORMAL • Sensitivity, INT: 1 Div or more, EXT: 1V p-p • Coupling, DC, TV SYNC.

20 MHz DUAL TRACE W/BUILT-IN COMPONENT CHECKER

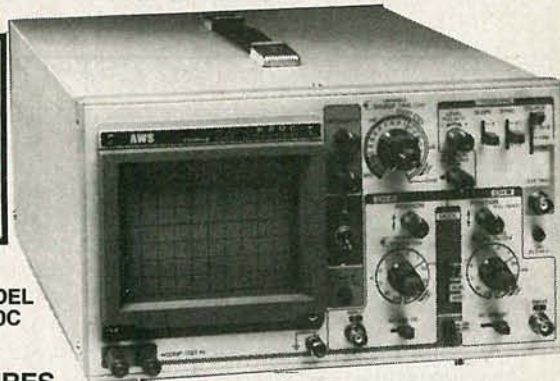

MODEL
620C

FEATURES

- Component checker for locating defective components in or out of de-energized circuits. • 6" high brightness, internal graticule CRT • TV (Video) sync filter • Z axis (intensity modulation) • High sensitivity X-Y mode • Front panel trace rotator • Low power consumption • 3PCB modular construction • Comes with 2 year warranty

SPECIFICATIONS

Vertical System CH. A and CH. B-Deflection Factor, 5mV/div- 20V/div, (±3%) 12 steps • Frequency Response, DC-20MHz (-3dB) • Risettime, 17ns or less • Maximum Input Voltage, 300 V (DC + AC peak) • Input Impedance, 1MΩ ± 5%, 20pF ± 3pF • Invert, CH-B only • Operating Modes, CH-A, CH-B, DUAL, ADD, X - Y • Internal Horizontal System (Sweep Operation)- Time Base, 0.2μs/div-0.5s/div (±3%) 20 steps • Magnification, 5x • Trigger System - Sources, INT, CH-B LINE, EXT • Modes, Norm, Auto • Coupling, AC, HF rej, TV • Slope + or - • Sensitivity, INT: 1 div or better, EXT: 1V p-p or better.

A.W. SPERRY INSTRUMENTS INC.

FEATURES A FULL 2 YEAR PARTS AND LABOR WARRANTY ON OSCILLOSCOPES.

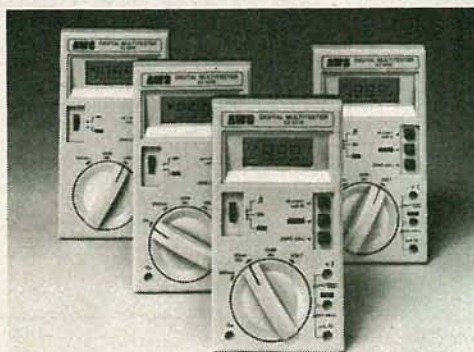

AWS DIGITAL MULTIMETERS

Models EZ-6100, 6110, 6200 & 6220

- Autoranging on volts and ohms
- Self-contained 10 Amp AC/DC ranges (EZ-6110 & 6220)
- Low power ohm ranges—applied voltage ≤ 0.3V.
- Continuity buzzer (EZ6100 & 6110), 5 settings
- Range hold (EZ6100 & 6110)
- Large 3½ digit LCD display
- 300 hours continuous operation

FIVE-YEAR WARRANTY



**TOLL FREE HOT LINE
800-223-0474**

THE TEST EQUIPMENT SPECIALISTS

26 WEST 46th STREET, NEW YORK, N.Y. 10036 • 212-730-7030

ADVANCE ELECTRONICS

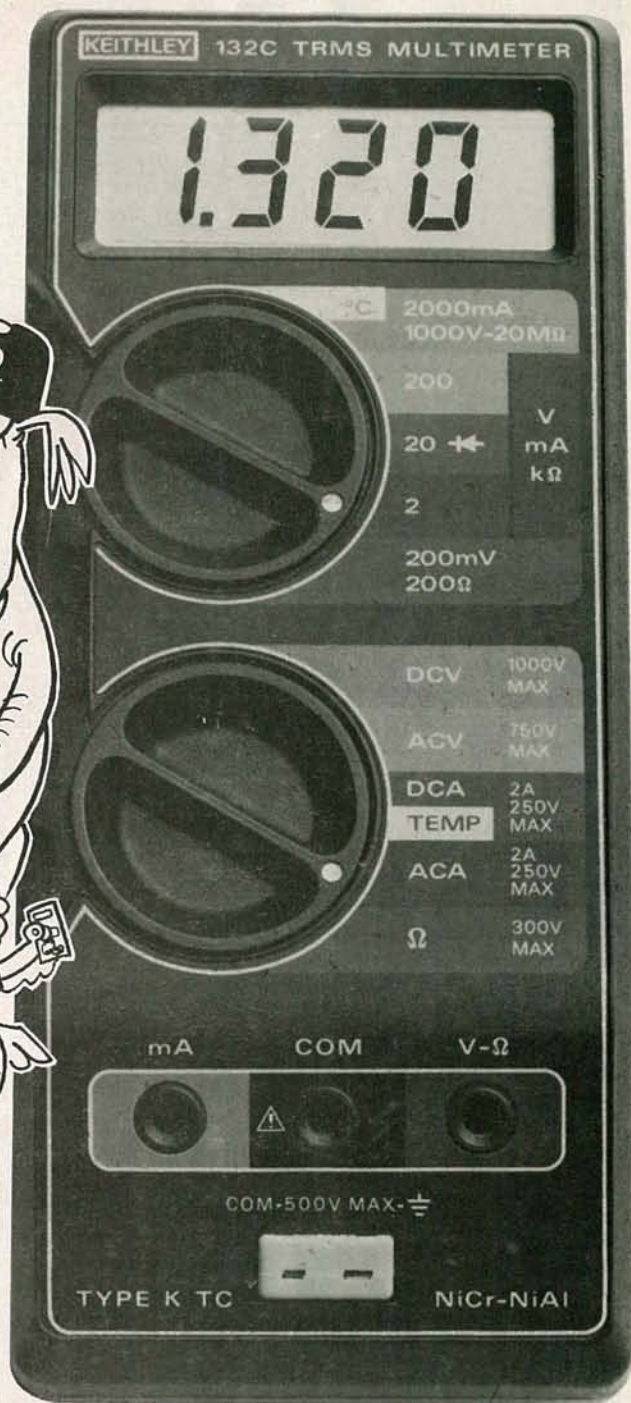
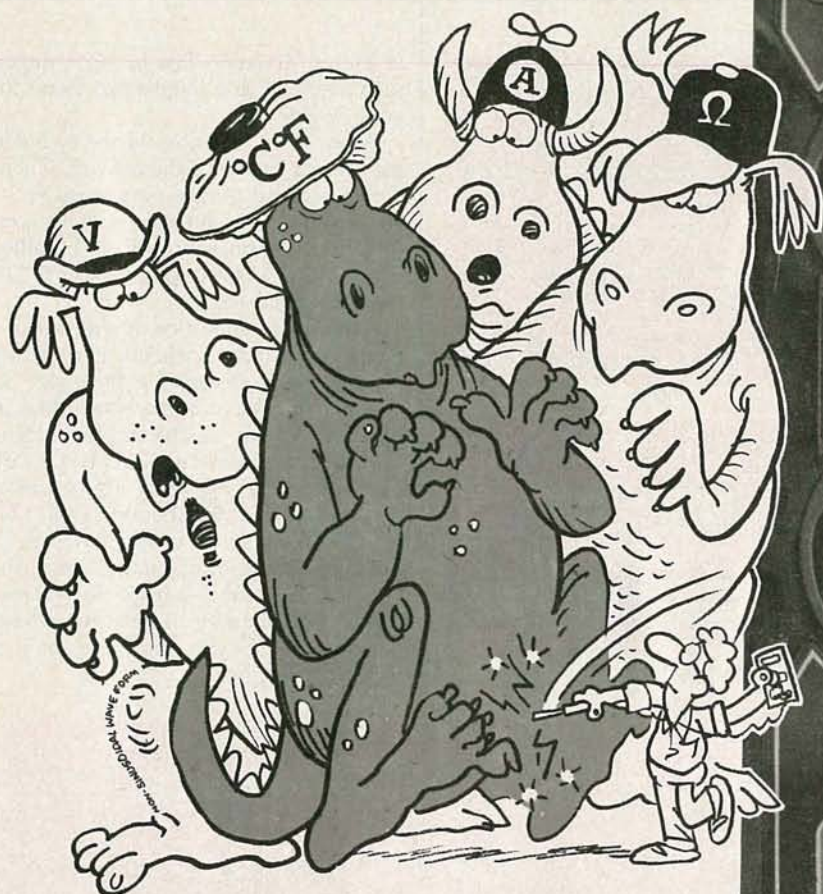

FREE temperature.

New from Keithley. TRMS DMM and Digital Thermometer all-in-one.

It's two-for-one to give you one less tool to worry about when you're fighting electronic and temperature dragons both. And both for the price of a TRMS DMM alone. It's the only combination DMM and digital thermometer to give you all the features listed here **and** our one-hand, no-mistake rotary thumb wheels. All backed by Keithley's 30-year reputation for lab accuracy. Keithley DMMs and thermometers. **The Dragon Slayers.**

KEITHLEY

Write Tom Hayden for free catalog on Keithley hand-held and bench DMMs, digital thermometers and DMM/thermometers . . . and get a free frameable 9 x 12" copy of our dragons. Keithley, 28775 Aurora Road, Cleveland, Ohio 44139. Phone 216-248-0400.

CIRCLE 9 ON FREE INFORMATION CARD

132 Features DMM

- Full range and function
- True RMS
- 0.25% DCV accuracy

THERMOMETER

- Fast response
- Thermocouple-based (Type K)
- Integrated TC connector — requires no adapter
- Choice of °F or °C models
- 0° to 2000°F, 1370°C
- \$199 °C/\$209 °F

MARCH 1983

79

HOBBY CORNER

Light-puzzle solution and more

EARL "DOC" SAVAGE, K4SDS, HOBBY EDITOR

THE FIRST ORDER OF BUSINESS TODAY IS to consider the responses to John Cirillo's light-switch problem that was presented in the November issue. The question, as you may recall, was how a single light bulb could be controlled independently by three single-pole double-throw switches. The word "independently" means that the light could be turned on and off from each switch regardless of the position of the other two switches.

It does seem that John's puzzle really got to you! Each day for several weeks, the mail included many letters about those switches. I read every one, checked it out, and put it into one of several stacks. The great majority of you got the switching correct, but I would like to share some ideas from some of the other stacks (of incorrect answers) before getting to the answer directly.

A small group of you did send circuits with three SPDT switches in which one or more positions of two switches made the third inoperative. In two circuits, certain combinations of positions placed a direct short across the AC line!

One reader, David Potts of Ohio couldn't work out an SPDT solution but he said that there is an easy solution if the three apartments are on three separate floors of a building. His solution is shown

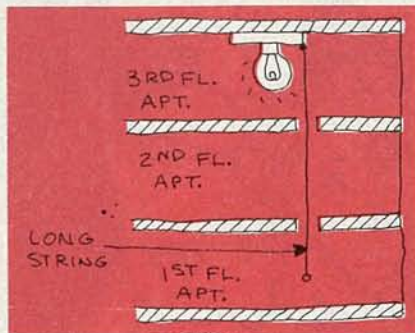

FIG. 1

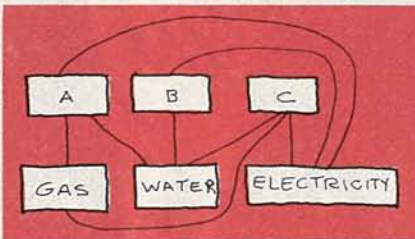

FIG. 2

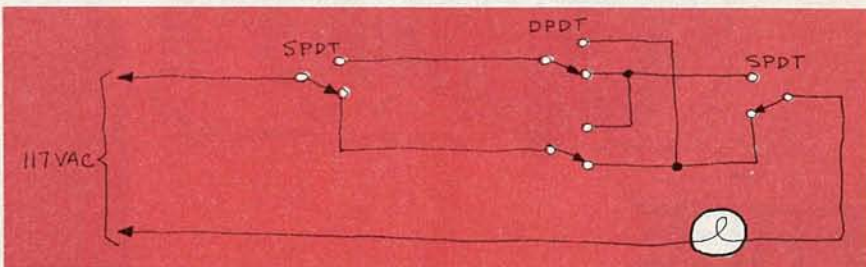

FIG. 3

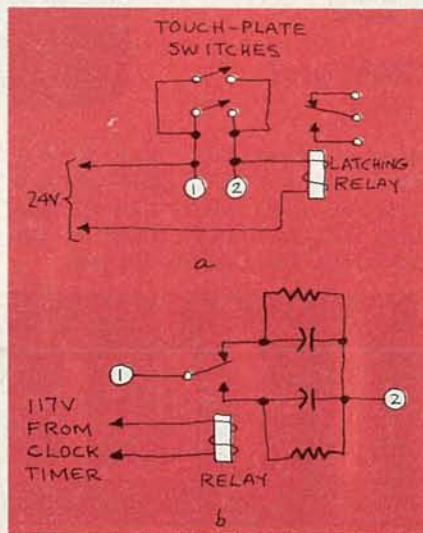

FIG. 4

in Fig. 1. It seems that he once rigged such a system in a lighthouse. Good for you, David.

A few of my friends out there chided me for not knowing the answer. Then, they proceeded to give me the answer—an answer which did **not** meet the conditions of John's problem. In other words, their answers did not use SPDT switches exclusively.

Actually, that question reminds me of a puzzle on which I whiled away many pleasant hours in junior high school. In case you have never run across it, look at the sketch in Fig. 2. The question here is how to serve three houses (A, B, C) with gas, water, and electrical utilities from their respective distribution points (G, W, E) without any branching lines. Each house must have direct, independent service and the kicker is that no line can cross another. (Come now, I have run all but one line—surely you can figure out how to run the last one!)

AN INVITATION

To better meet your needs, "Hobby Corner" will undergo a change in direction. It will be changed to a question-and-answer form in the near future. You are invited to send us questions about general electronics and its applications. We'll do what we can to come up with an answer or, at least, suggest where you might find one.

If you need a basic circuit for some purpose, or want to know how or why one works, let us know. We'll print those of greatest interest here in "Hobby Corner." Please keep in mind that we cannot become a circuit-design service for esoteric applications; circuits must be as general and as simple as possible. Please address your correspondence to:

Hobby Corner
Radio-Electronics
200 Park Ave. South
New York, NY 10003

As you may have gathered, no one came up with independent control of a light with three SPDT switches. A number of you took the time to offer a proof that there could be no solution to the problem as stated. The closest thing to a solution, as most of you pointed out, requires one DPDT and two SPDT switches. Such a circuit is shown in Fig. 3. Check it all you like—each switch can turn the light on or off regardless of the positions of the other two.

I must agree with those of you who thought that John somehow missed seeing in one of the apartments a DPDT or "four-way" switch. For those of you who have not seen this circuit before, be advised that you can put as many DPDT switches as you wish between the SPDT switches on the ends. Thus, you can have independent control of a light that can

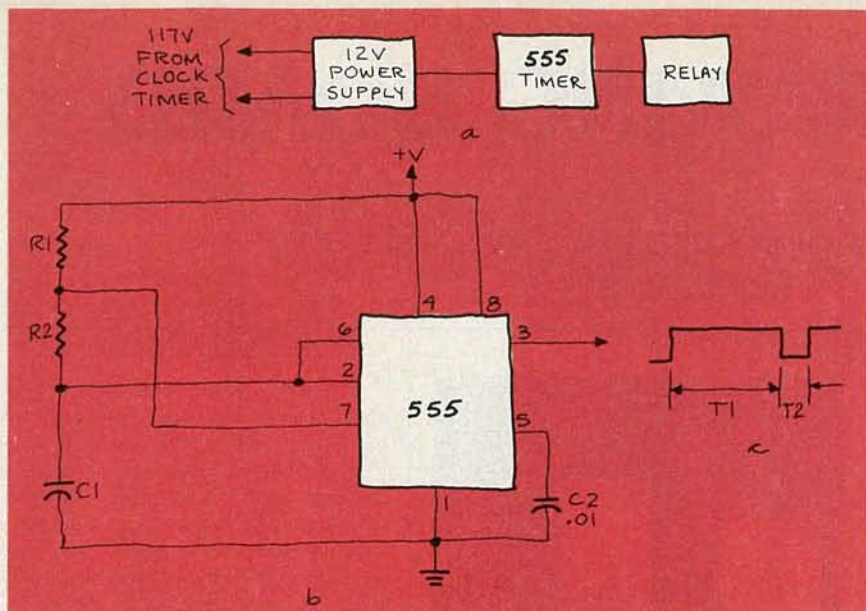

FIG. 5

come from any number of locations.

John should be sleeping soundly now that he knows no one else can solve his problem either. Thanks to all of you who responded to John's question.

Touch plate timer

Robert Allen of Washington has a low-voltage "touch plate" wiring system in his home. That is one in which momentary switches operate 24-volt latching relays which control lights, outlets, and so on. You should note that any number of parallel switches can control any one relay. That is a very effective system for several reasons but it does have a disadvantage.

With the setup as shown in Fig. 4-a, what kind of timers can you use to turn lights on and off at preselected hours? Robert's best solution to date is to use a 120-volt relay between the timer and the touch-plate circuit as shown in Fig. 4-b. It does the job but not with complete dependability. In the absence of frequent contact cleaning, it gets out of synchronization and turns the lights on when they should be off and vice versa.

Well, Robert, why not use the familiar 555 IC timer to produce the controlling pulses? As shown in Fig. 5-a, a clock timer would control a 12-volt power supply for an astable 555 timer set to pulse the latching relay at the desired hours. That relay itself is a SPST latching-type that closes with the short pulses from the 555.

The 555 circuit and its output waveform are shown in Fig. 5-b. The values of R1, R2, and C are determined by the desired times. The relay contacts will close when it sees the leading edge of the pulse (low-to-high transition). Time t_1 , the length of the pulse, can be determined by the formula: $t_1 = 0.693 \times (R1 + R2) \times C$. Time t_2 , the length of time between pulses, can be determined by the formula:

$$t_2 = 0.693 \times R2 \times C.$$

The length of time that your light will be on is the sum of t_1 and t_2 and is equal to $0.693 \times (R1 + 2R2) \times C$.

Set the clock timer to apply 12V to the 555. When power is first applied to the 555, the lights turn on. The next low-to-high transition (after time t_2) turns the lights off. Set the clock timer so that it goes off and removes power from the circuit before the 555 produces a third pulse (the third pulse would turn the lights back on).

Depending upon the intervals desired, you may need to cascade a couple of 555 IC's or insert a counter IC between the 555 and the relay.

That is an effective but fairly cumbersome approach to the problem. Next month I'll show you how to do the job in a much simpler way with a digital clock. Stick around. **R-E**

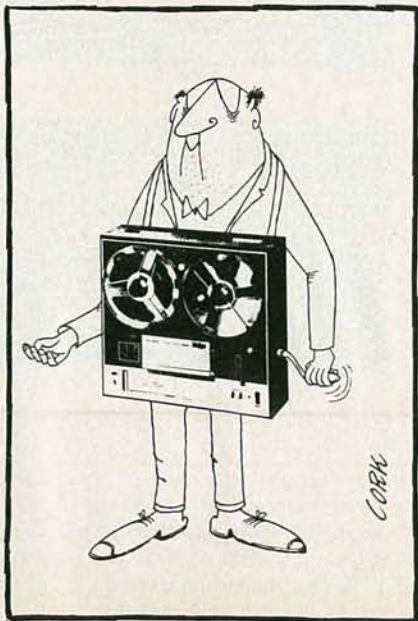

BIG PERFORMANCE
small PACKAGE

Model 240



Video Generator

- Video output for all VCR, CCTV and Monitor Applications ± 1 volt into 75 Ω load
- RF output: CH 2, 3, 4
- Scope trigger output for V or H sync
- 10 step gray-scale staircase signal for video circuit analysis
- 10 bar and 3 bar gated rainbow pattern
- 8 other dot, bar and line patterns
- Operates from 2 std. 9V batteries or 115VAC
- Single slide switch control
- Complete with test leads, protective cover, AC adapter, comprehensive instruction manual

PRICED UNDER \$200.
THE 240 DOES SO MUCH
FOR SO LITTLE!!

HICKOK
the value innovator

THE HICKOK ELECTRICAL INSTRUMENT CO.
10514 Dupont Avenue • Cleveland, Ohio 44108
(216) 541-8060 • TWX: 810-421-8286

THE DRAWING BOARD

Adding a digit select to a BCD encoder

ROBERT GROSSBLATT

IF YOU BREADBOARDED THE BCD ENCODER we designed last month you found (we hope) that it was a trouble free, reliable circuit. However, its use was somewhat limited because the encoded data wouldn't latch and only one digit at a time could be placed on the bus. This month we're going to add additional logic to the circuit so that we can display and latch up to 10 digits at a time. We'll stick to the set of design criteria we listed last month and we'll use the same sort of step-by-step approach to add the new sections to our design. The choice of components will still be weighted in favor of those that are easily available and reliable, and that put the smallest possible dent in your wallet.

The digit select

We want the digit select to sequentially address one thing after another. You could use some sort of shift-register approach for that, but the clocking can be a problem and the package count can get pretty heavy. There's a neater way to solve the problem that also happens to work out better in the long run. Not only can we solve the addressing problem with only two IC's, but expanding the circuit to handle ten digits will only call for one additional IC.

Instead of the shift-register approach, we'll create an input data bus and design circuitry that will enable one digit at a time. We take the "any key pressed" output of our BCD encoder and use that to clock a 4017 one-of-ten decoder. That means that each time we close one of the keyboard switches, we put a corresponding nybble (4 bits) on the data bus and the 4017 puts a high on one of its output pins. A new digit entry will result in a new nybble on the bus and a new high from the 4017. That continues for up to ten entries (sequentially). Figure 1 shows how you would connect the 4017 to handle four digits with the encoder circuit we started last month. Although the circuit will handle ten digits we'll limit our illustration to four. (The principle is the same and it makes the circuit easier to understand.)

Capacitor C8 serves the same purpose that C1 did in last month's circuit. It gives us a reset to zero at power-up and makes sure that everything starts out at the beginning. With the 4017 set up as shown in Fig. 1, it will reset after four low-to-high

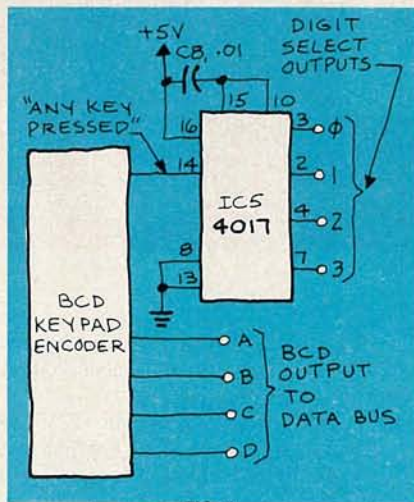

FIG. 1

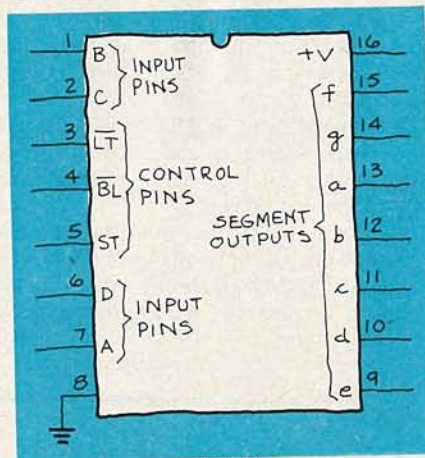

FIG. 2

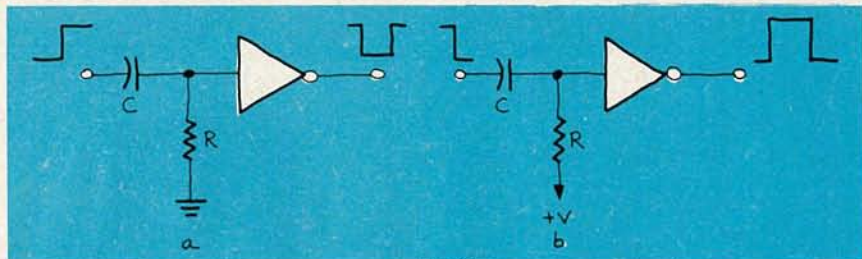

FIG. 3

transitions of the "any key pressed" output. If you want it to handle more than four digits all you have to do is connect the RESET pin, (pin 15), to the numbered output that is one past the number of digits you want to deal with. If you want to go all the way and encode ten digits, ground pin 15 through a 1K resistor.

Figure 2 shows the pinouts for a 4511—the decoder we will use to drive our display. The LAMP TEST and BLANKING control pins (pins 3 and 4) are active low and should be kept high for normal operation. The STORE input controls the internal latch and is active high. If it's held low, the 4511 will decode whatever BCD data is presented to its inputs. If it's made high it will latch and display the last nybble on the bus at the moment it went high. Any invalid BCD code will blank the display.

The obvious step in creating our data bus is to connect the A, B, C, and D inputs of the 4511's together and tie them to the appropriate BCD outputs of the encoder. Our four digit-select outputs would be connected to the STORE pins of the respective 4511's and we would be in business. Unfortunately that would fail miserably and a moment's reflection will show you why. The outputs of the encoder are constantly scanning from zero to nine at the clock rate, so the 4511's that weren't selected would display constant eights—and not even real eights at that. The selected digit would display the keyed number but would go to eights as soon as the digit selector shifted to the next digit.

What we need is a way of delivering a brief pulse to the STORE pin to open the latch just long enough to enter the nybble at the selected 4511. Now, pulse generators are a dime a dozen, and perfectly workable ones can be built with 555's and other IC's. In real down-and-dirty situations, you can get by with just a capacitor

and a resistor, but the discharge time of the capacitor creates a very sloppy slope at the trailing edge of the waveform. The easiest way to get the job done and still be true to our design criteria is to use a half monostable.

Fig. 3 shows the basic configuration of half monostables. In actual fact they

SWD-1 VIDEO CONVERTER

FOR CABLE TV



The SWD-1 Video Converter is utilized on cable TV systems to remove the KHz's signal from a distorted video (channel 3 in/out) and also pass thru the normal undistorted/detected audio signal. Rocker switch selects operating mode to remove KHz's distortion from the video or pass all other channels normally. Simple to assemble—less than 30 minutes. Pre-tuned. Input/output Channel 3. Impedance 75 ohms. 117VAC.

SWD-1 Video Converter Kit \$69.95

VTR ACCESSORIES

SIMPLE SIMON VIDEO STABILIZER



Simple Simon Video Stabilizer, Model VS-125, eliminates the vertical roll and jitter from "copy guard" video tapes when playing through large screen projectors or on another VTR. Simple to use, just adjust the lock control for a stable picture. Once the control is set, the tape will play all the way through without further adjustments. Includes 12V power supply.

VS-125 Video Stabilizer, wired Reg. 54.95... **\$39.95**

NEW VCR Quality

MODULATOR

Not a Game Type Modulator



The MPS-1 Kit converts Video/Audio signals to a crystal controlled RF output for TV Channels 3 and 4. The MPS-1 Modulator inputs are designed to match all TV Cameras and VCR's and features a voltage regulated power supply, power switch and LED indicator. No Tuning Required. Operates on 117VAC.

MPS-1 Kit \$39.95

Assembly Time Approximately 5 Minutes

UHF ANTENNAS and ACCESSORIES

MDS-AMATEUR-ETV 32 ELEMENT YAGI ANTENNA



- Not A Kit
- 1.9-2.5 GHz
- 38 1/2" Long
- 23dB Average Gain
- Commercial Grade
- Die Cast Waterproof Housing with 4 1/2" x 2 1/2" Area for Electronics

MAE-2 32 Element YAGI Antenna \$23.95

Kato Sons' Down Converter Kit ★1.9 - 2.5GHz★

Designed for Simple Simon by former Japanese CQ Amateur Magazine's UHF Editor/Engineer. Unit utilizes new ingenious Printed Circuit Probe for maximum gain. Circuit board fits inside MAE-2 antenna housing. Requires 1 hour assembly. IC and capacitors pre-soldered.

Model KSDC-KIT 1.9 - 2.5GHz Down Converter Kit \$34.95

Kato Sons' Regulated Variable DC Power Supply

For use with KSDC-KIT 1.9 - 2.5GHz Down Converter. Completely assembled with Attractive Cabinet, TV/Converter Mode Switch, Frequency Control and LED Indicator.

Model KSPS-1A Assembled Power Supply \$23.95

SPECIAL INTRODUCTORY SAVINGS

ORDER ALL THREE ITEMS

MAE-2, KSDC-KIT and KSPS-1A for Only **\$74.95**

Regular price if ordered separately \$82.85

— CO-AX CABLES ARE NOT INCLUDED —

ZYZZX VHF-UHF Wideband Antenna Amplifier

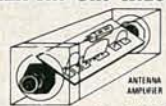

Revolutionary New HYBRID IC Broadband Amplifiers

50 MHz - 900 MHz

Model ALL-1 12dB Gain

Model ALL-2 35dB Gain

These units are not available anywhere else in the world. Each unit will serve many purposes and is available in Kit or Assembled form. Ideal for outdoor or indoor use. I/O impedance is 75 ohms. Amplifiers include separate co-ax feed power supply. Easily assembled in 25 minutes. No coils, capacitors to tune or adjust.

ALL-1 Complete kit w/power supply \$24.95 ALL-1 Wired/Tested w/power supply \$34.95

ALL-2 Complete kit w/power supply 34.95 ALL-2 Wired/Tested w/power supply 44.95

Our New STVA 14.5dB GAIN, 14 ELEMENT CORNER REFLECTOR YAGI ANTENNA



STVA-3 Yagi Antenna, 14.5dB Gain, Selectable 75 or 300 ohm Channel 60-80 \$19.95

STVA-4 Yagi Antenna, 14.5dB Gain, Selectable 75 or 300 ohm Channel 44-52 \$19.95

RG-59/U 75 ohm Low Loss Coax Cable, \$1.12/ft. F-59 Coax Connector, \$.39 ea.

MT-1 Special UHF 75-300 ohm Matching Transformer \$1.45 ea.

Switch to Bambi!™

Electronically

Bambi Electronic Video Switch ... makes switching of your VCR/VTR, Pay TV Decoders, Cable TV, Video Discs, Video Games, Closed Circuit TV, Antennae and Microcomputer as easy as pushing buttons.

The Bambi Electronic Video Switch is an electronic switching network which can accept up to six different sources of video signals and provide the flexibility of directing the inputs to any or all of the three outputs.

Now you can eliminate ... the drudgery of disconnecting and reconnecting your video equipment each time you use it ... the tangled mess of cables which are impossible to trace out ... not being able to use more than one function at a time.

Bambi lets you enjoy using your video equipment the way it should be ... electronically and on line at the push of a button.

Model BEVS-1 Completely Wired and Assembled. Includes comprehensive Instruction/Operation Manual and Decal Set for customizing your Video Switch installation.

\$129.95



FREE Bambi Poster with any purchase



Bambi's front panel was designed with the user in mind. Computer styled construction, with soft-touch keyboard (rated for over 10 million operations), arranged in matrix form allows easy input/output selection without referring to charts. Functions selected through the keyboard are immediately displayed on the 18 LED status indicators.



Check the quality of Bambi against that of much higher priced competition. All solid state electronic switching provides low attenuation (3dB), wide frequency response (40-890 MHz), and excellent isolation between signal sources (each I/O section individually shielded for 65dB min. isolation).

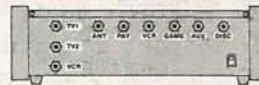

Bambi's Specifications:

- Input/Output Impedance 75 ohm
- Signal Loss 3dB ±1dB
- Noise 4dB ±1dB
- Input Return Loss 12dB min.
- Isolation 65dB min.
- Power Req. 117VAC 60 Hz, 2W
- Dimensions 10 1/4 W x 6 1/4 D x 3 1/4 H
- Weight 4 1/2 lbs

7+11 PWD PARTS KITS

INTRODUCING OUR 7+11 PWD PARTS KITS

ITEMS 1-15 SPECIAL \$129.95

| KIT No | PART No | DESCRIPTION | PRICE |
|--|------------|---|---------|
| 1 | 1VT1-PWD | Varactor UHF Tuner | \$24.95 |
| 2 | 2CB1-PWD | Printed Circuit Board, Pre-drilled | 18.95 |
| 3 | 3TP11-PWD | PCB Potentiometers 4-20K, 1-5K, 2-10K, 2-5K, 1-1K, and 1-50k. (11 pieces) | 8.95 |
| 4 | 4FR-31-PWD | Resistor Kit, 1/4W, 5% 29-pcs, 1/2 W 2-pcs | 4.95 |
| 5 | 5PT1-PWD | Power Transformer, PRI-117VAC, SEC-24VAC at 500ma | 9.95 |
| 6 | 6PP2-PWD | Panel Mount Potentiometers and Knobs, 1-1KBT and 1-5KAT with switch | 5.95 |
| 7 | 7SS17-PWD | IC's 7-pcs, Diodes 4-pcs, Regulators 2-pcs Transistors 2-pcs, Heat Sinks 2-pcs | 29.95 |
| 8 | 8CE14-PWD | Electrolytic Capacitor Kit, 14-pieces | 6.95 |
| 9 | 9CC20-PWD | Ceramic Disk Capacitor Kit, 50 WV, 20-pcs | 7.95 |
| 10 | 10CT5-PWD | Variable Ceramic Trimmer Capacitor, 5-85pfd, 5-pieces | 4.95 |
| 11 | 11L5-PWD | Coil Kit, 18mhs 3-pcs, 22µhs 1-piece (prewound inductors) and 2 T37-12 Ferrite Toroid cores with 6 ft. #28 wire | 6.00 |
| 12 | 12ICS-PWD | IC Sockets, Tin inlay, 8 pin 4-pcs, 14 pin 1-pc and 16 pin 2-pcs | 2.95 |
| 13 | 13SR-PWD | Enclosure with PM Speaker and Pre-drilled Backpanel for mounting PCB and Ant. Terms | 14.95 |
| 14 | 14MISC-PWD | Misc. Parts Kit, Includes Hardware, (6/32, 8/32 Nuts & Bolts), Hookup Wire, Solder, Ant. Terms DPOT Ant. Switch, Fuse, Fuseholder, etc. | 9.95 |
| 15 | 15MC16-PWD | Mylar Capacitors, 14-pcs and Silver Mica Capacitors 2-pieces | 7.95 |
| When Ordering All Items, (1-15), Total Price | | | 159.95 |

CUSTOMER NOTICE: BUY WITH CONFIDENCE... BEWARE OF LOW QUALITY IMITATORS. All of our kits consist of New, 1st Class, RF Quality, Parts Engineered for Optimum Operation, not factory seconds or stock close-outs. We service your completed kits that you've purchased and built. You will never get stuck with a BAG OF PARTS when ordering from Simple Simon.

SIMPLE SIMON ELECTRONIC KITS,™ Inc.

3871 S. Valley View, Suite 12, Dept. R, Las Vegas, NV 89103

NEED 6 OR MORE OF AN ITEM? WRITE FOR QUANTITY DISCOUNTS

In Nevada Call: 702-871-2892

1-800-782-3716

Outside Nevada Call:

Available by Mail Order Only
Send Check* or Money Order. Minimum Order: \$16.95. Add 10% Shipping and Handling on orders under \$40.00. For orders over \$40.00, add 5%. Minimum Shipping and Handling \$2.00. Cat. \$1.00 — VISA and Mastercard Acceptable — *Check orders will be held 30 days before shipping.

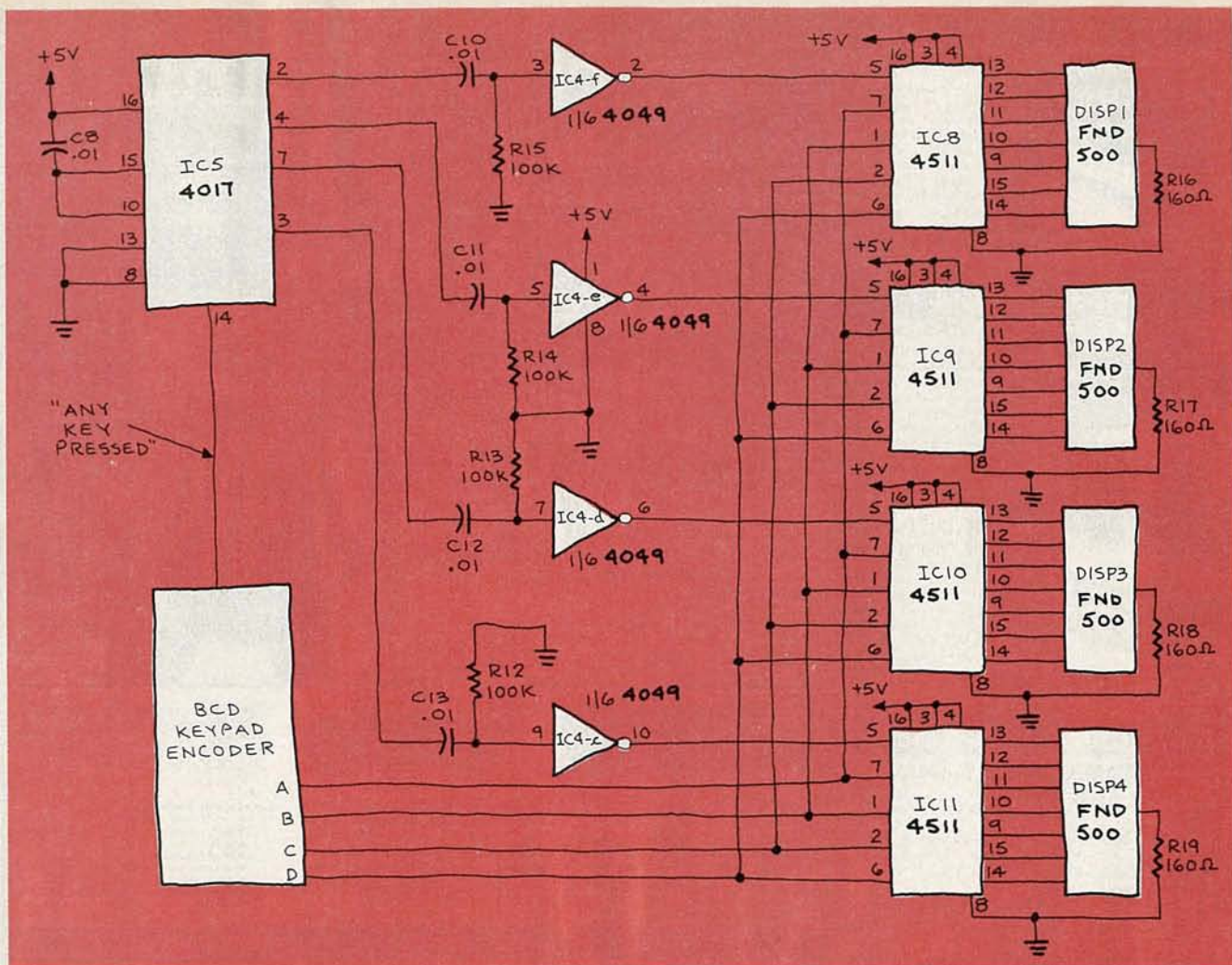

FIG. 4

should really be called edge detectors because they respond to either the leading or trailing edge of a logic level transition. With resistor R connected to V+, the gate input is held high. When the input goes low it forces the gate to change state for a period of time determined by the values of the resistor and the capacitor. The duration of the output pulse depends on the R-C value and the slope of the waveform depends on the transition time of the gate. A 4049 is a good choice here because it has enough internal gain all by itself to clean up the sloppy edge of the input waveform. The inherent hysteresis of a Schmitt trigger also makes it a good candidate for a half monostable. If you build those circuits with non-inverting gates, the same analysis applies but, of course, the output pulses will be in the opposite direction. The "big if" with these half monostables is that the input pulse has to be longer than the desired output pulse.

That is really self evident—a moment's thought will tell you that you have to give the capacitor enough time to charge up. If that condition isn't met the circuit won't blow up, but the output pulse will be the same width as the input pulse. In our case that's not a problem because the outputs

of the 4017 latch high when they're decoded. All we have to do is make sure the output pulse-width of the half monostable is less than the fastest speed we can enter data from the keyboard. One millisecond should be fast enough for anybody—even for the world's fastest supermarket cashier.

In Fig. 4 we've completed the digit selector and display and connected it to the encoder we built last month. When we turn the power on, the 4017 is reset to zero and pin 3 goes high. Since the negative-to-positive transition is what triggers the half monostable, the first digit we enter will be on the negative-to-positive transition of output No. 1 (pin 2) of the 4017. That's why the schematic shows the zero output (pin 3) of the 4017 connected to the last digit.

In any event, as soon as power is applied, the circuit prepares itself to enter the first digit. When we close one of the keyboard switches, a BCD nybble is held on the data bus and the 4017 goes high on output No. 1. That triggers the half monostable and opens the 4511's latch just long enough to enter the nybble and then closes it again. The result is that the selected number appears in the display and stays there. When a second keyboard

switch is closed, the 4017 enables the latch in the second 4511 and the number appears in the second display. That whole procedure continues until the fourth digit is entered and the 4017 resets. From that point on, the entered digits will write over the previously entered ones. The 4511 is designed to be used with common-cathode displays; we used Fairchild FND-500's. Only one current-limiting resistor was used for each numeral because I don't mind the slight differences in brightness that shows up when different numbers are displayed. If you want the numbers to be all of equal intensity, connect the cathodes of the display directly to ground and get yourself a huge supply of low-value resistors because you've got to put one on the line between each 4511 output and LED anode. Keep in mind that the 4511 can only supply about 25 milliamps per segment, so choose the resistor value accordingly. You can play with this circuit for a while but it will soon be painfully obvious that it leaves a bit to be desired.

Since we don't have any access to the nybble in the internal latch of the 4511 and decoding the segment outputs is, to put it mildly, a strange way to go about
continued on page 99

CABLE TV CONVERTERS DESCRAMBLERS

BUY DIRECT & SAVE



**40 CHANNEL
CONVERTER**
\$38 Regular \$69

Advanced Solid State design and circuitry allows you to receive mid & super band channels. Restores programming to Video Recorders.



**36 CHANNEL
REMOTE CONTROL
CABLE CONVERTER**
\$88.00

**LINDSEY JET 1 WIRELESS
THE ULTIMATE CABLE T.V.
CONVERTER**



**36 CHANNEL
INFRARED
REMOTE CONTROL
COMPLETELY
PROGRAMMABLE**
\$169.00

Send \$1 for Complete Catalog
VISA • MASTERCARD • COD

DIRECT VIDEO SALES

P.O. BOX 1329
JEFFERSONVILLE, INDIANA 47130
CALL TOLL FREE
1-800-626-5533

CIRCLE 76 ON FREE INFORMATION CARD

ENGINEERS CHOOSE PANAVISE!

Being professionals, they demand the very best.

**CONVENIENT
PORTABLE
VERSATILE
ACCURATE**

Model 381 Vacuum Base Panavise

PANAVISE, America's largest manufacturer of work positioners has a full line of interchangeable bases and heads to fit all your laboratory and production line needs.



Our catalog explains it all.
Send for one today.

For more information, contact your dealer or PANAVISE

PANAVISE PRODUCTS, INC. 2850 E. 29th St., Long Beach, Ca. 90806 (213) 595-7621



Prices subject to change without notification.

Suggested Retail Price \$37.95

CIRCLE 21 ON FREE INFORMATION CARD

POCKET SCANNER CLOSE OUT

Thanks to a European Distributor's overstock, you can get a great deal on a pocket scanner.

It's a six channel, three band unit that is actually the smallest scanner available on the market. You'll hear your choice of police, fire and emergency calls and get extra features like channel lock-outs, manual control, two antennas plus an AC

\$79.95

Includes TWO FREE frequency crystals. Additional crystals \$4.95 ea., other accessories available.

charger/adaptor. Coverage includes UHF bands, VHF high bands and mid-band.

We've taken what is already a good value and made it a steal! From the original price — the equivalent of \$190 — we've lowered the price a full \$110. Plus you get two frequency crystals of your choice at absolutely no charge. And, you'll have our 25 day no-hassle refund privilege so you can try it out before making your decision. Don't Delay. Supplies are limited. Call Today. 24 hrs. a day 7-days a week.

Order product 1050. Visa/Master Charge or COD customers may call toll free. Or send check for \$79.95 plus \$2.00 shipping and handling. 90 day warranty.

MTN 800-528-6050. Ext. 1035

P.O. Box 215 In AZ 800-352-0458 Ext. 1035
Yankton, S.D. 57078

CIRCLE 20 ON FREE INFORMATION CARD

Be an FCC LICENSED ELECTRONIC TECHNICIAN!



Earn up to \$600 a week and more!

Learn at home in spare time. No previous experience needed!

No costly School. No commuting to class. The Original Home-Study course that prepares you for the FCC Radiotelephone license exam in your spare time! Passing the exam is your "ticket" to thousands of exciting opportunities in Communications, Broadcasting, Mobile two-way systems, Microwave stations, Radar installations, Aerospace and more.

NO NEED TO QUIT YOUR JOB OR GO TO SCHOOL

You learn how to pass the FCC License exam at home at your own pace with this easy-to-understand, proven course. Within a few short weeks you could be on your way to being one of the highest paid workers in the electronics field. It's that easy! U.S. Federal law requires you to have an FCC License if you want to operate and maintain virtually any communications system — you don't need a College degree to qualify, but you DO need an FCC License. With this Home-Study course, you'll be ready to pass the FCC Government licensing exam in a remarkably short time. Send for FREE facts now. No obligation. No salesman will call. **MAIL COUPON TODAY!**

COMMAND PRODUCTIONS

FCC LICENSE TRAINING, Dept. E
P.O. Box 2223, San Francisco, CA 94126

Rush FREE facts on how I can prepare for my FCC License at home in my spare time.

NAME _____
ADDRESS _____
CITY _____ STATE _____ ZIP _____

CIRCLE 30 ON FREE INFORMATION CARD

MARCH 1983

85

SERVICE CLINIC

Troubleshooting thermal problems

JACK DARR, SERVICE EDITOR

A LOT OF THE PROBLEMS WE RUN INTO are temperature-related. Transistors are inherently temperature-sensitive. And, if you think things are bad now, you should have seen some of the early sets that used germaniums! Their normal leakage is much greater than silicon transistors, and the hotter they get, the worse the leakage gets. Leakage increases almost linearly with temperature, until it "stops the works." In a curve tracer, the "fingers" of the curve start out fairly straight, and then curl as the temperature is raised, until the pattern looks like the one shown in Fig. 1. That's why you find such huge heat-sinks in early models.

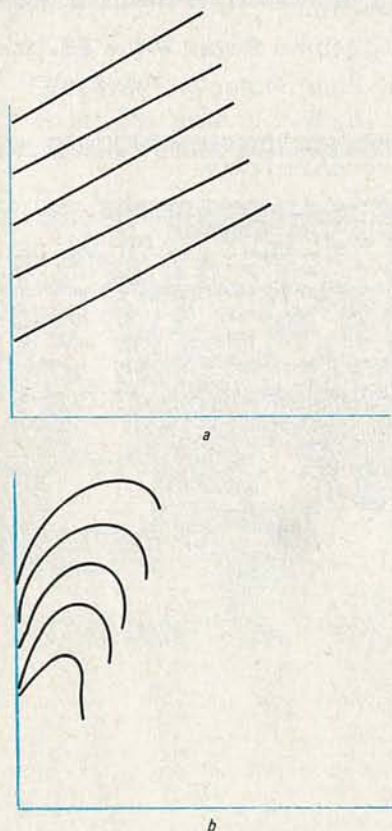

FIG. 1

Silicon transistors also can have that type of problem, especially if they aren't derated enough. (See Service Clinic in the October 1982 *Radio-Electronics* for more on that.) Even IC's will do it. In one case (a small import black-and-white TV

set) the sound would distort badly after it was on for about an hour. After much experimenting, and hard thinking, we found that the IC that handled the sound was the cause. Cooling the IC down brought the sound back. Adding a heat-sink cured the problem.

The key symptom in thermal problems is what we'll call the "time-constant"—the length of time the set runs before the problem appears. If that length of time is always about the same, the cause is very likely to be thermal. There's a sub-symptom here that can help. Short time constants (for anywhere up to 5-10 minutes) point to a problem that's apt to be in a power-handling circuit—some part that normally carried a good deal of current.

Some potential problem sources are resistors that overheat and change value, transistors that develop more and more leakage as they warm up, and (watch this one!) small, low-voltage electrolytic capacitors that have some leakage to begin and which gets worse as the set runs and they warm up. (I have a built-in suspicion of all low-voltage electrolytics anyhow, especially in the cheaper sets.)

If the time constant is quite long—anywhere from a full hour up to several hours—the trouble is apt to be in some part or circuit that normally does not develop enough power to get hot "by itself." The heat that causes the trouble is either conducted through the chassis or PC board to the part, or radiated from a nearby part that gets quite hot.

In the first case (power-handling parts) wait till the problem occurs and then carefully feel various parts to see which one is too hot. (Carefully! Some of them can get really hot.) Faulty voltage regulators are a common cause of those problems.

If the problem seems to be thermal, there are two things you do to find the cause: either heat or cool the suspected circuit or component to see if you can make the problem show up or go away. Cooling is the easier way. Just spray coolant on suspected parts to see what happens. The best type of spray coolant is the one with a long thin nozzle that lets you hit only one part at a time. Metal nozzles are thinner but plastic is safer!

Application of heat is a bit more difficult, but not impossible. A heat-gun like the Wahl *Thermal Spot* is ideal. It has a nozzle so that you get the heat right

where you want it. If you don't have one, sneak out your wife's hair-drier, and rig up a plastic nozzle to give a smaller stream of hot air.

I've run across a bunch of sets with real oddball problems over the years. One of my pet oddballs is a tube from a set that would work perfectly for a minute then go out. It was the AGC tube. When I tried it in a tube-tester, it would come up to normal for exactly 60 seconds, then drop to zero! It would do this over and over. I've still got the tube on my bench!

One my favorite solid-state oddballs was a transistor, used as the 3rd video IF. When I tried it in a curve tracer, I would see a perfect pattern at room temperature. If I held the tip of a soldering iron near the case for a few seconds, pow—it would drop to zero. Let the transistor come back to room temperature and up it would come up normal again. If I sprayed coolant on it, out it would go. When it warmed up, it would come back! The thing would work perfectly over a range of temperature that couldn't be more than about 5 or 6 degrees! You can imagine what it did in the set. On a cold morning it wouldn't work till the room heated up!

All thermal problems aren't transistors either. Bad solder joints can either open up or close with temperature. Here again, the spray coolant and heat gun can save you an awful lot of time in pinning down the cause of the problem. The oddball in this department was a solder joint with a nice sharp spike of solder sticking up out of it. When the set heated up enough, this spike would penetrate the plastic insulation of a wire too close to it. (That one took a while to find, too.)

Hot IC's can cause some problems such as the sound problem mentioned previously. In another set, the color would drop out. The 3.58-MHz oscillator was a simple op-amp type IC. When it got hot, it went out. That was pinned down by spraying coolant on it. Replacing the IC turned out to show the same symptoms! The fix was attaching a good sized, very thin aluminum heat-sink to the case of the IC. That kept the temperature down to the point where it still worked. The heat sinks can usually be cemented to the top of the case, or if there's room, held by a clamp to the chassis.

At first, they told us that solid-state sets ran cool. That is true—they run cooler than tube-type sets, but from much field

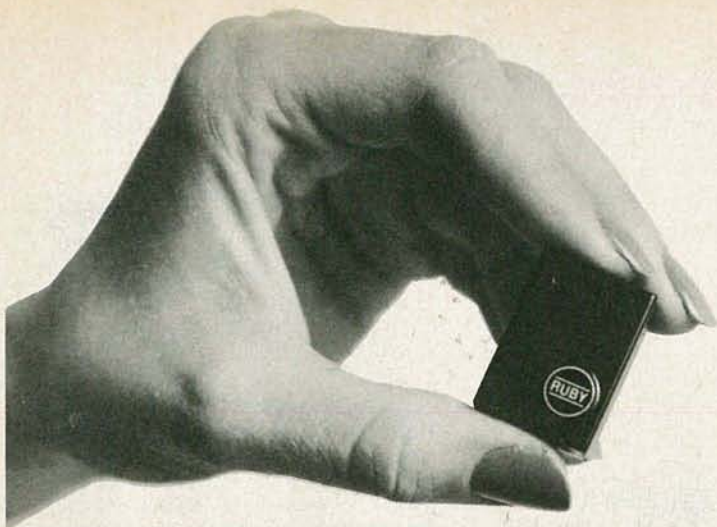

Bionic "Ears"

Tiny, powerful electronic sensors give you superhearing — through walls, up to 1/2 mile away.

The Dyna-Mike Transmitter

It's smaller than a quarter. But DYNA-MIKE will transmit every sound in the room to an FM radio tuned to the proper unused frequency, up to half a mile away.

If you're at a neighbor's home a block from your own, you can hear your baby's cry, or you can tell the instant your spouse comes home. If two of you are driving tandem in two cars, one or both of you can communicate with the other even if other cars drive between you.

DYNA-MIKE has as many uses as your imagination can think of. For a business conference, let the tiny microphone sit unobtrusively on the table or concealed on a shelf, and you'll be able to record every word. For businesses, put an FM receiver in a warehouse or remote office and "broadcast" instructions or orders to be filled.

Public speakers never had a better friend than the DYNA-MIKE. No wires or setup — just turn on one or more radios and your speech will come through with perfect fidelity. Put one on the front porch. If you hear a suspicious sound, turn on the radio and you'll hear the doorbell or even a muttered conversation.

Choose Your Model

New Horizons is introducing three models of the DYNA-MIKE supersensitive broadcast microphone. Model AR-7 is the world's smallest microphone. It's a miracle of electronic miniature power, with a range of 750 feet and a battery life of 90 hours. Introductory price is \$129.95 (two for \$119.95 each).

Model 9-DX is a long-range microphone, broadcasting an unbelievable half-mile distance. This miniaturized wonder is \$149.95 (two for only \$139.95 each). Normal battery life is 25 hours, or you can have the special Power-Pak, which operates 200 hours, for \$19.95.

The AR-7 and 9-DX are sensitive. They'll pick up sounds from 40 feet away. But for super-sensitivity, nothing beats the A-5.

The A-5 will pick up a whisper from more than 60 feet away and broadcast it to a receiver 750 feet distant. The A-5 comes with a special 200-hour long-life battery and is introductory-priced at \$99.95 (two for only \$89.95 each).

The Telephone Voice Changer

It's right out of James Bond! Push a button and the VOICE CHANGER gives your voice completely different characteristics. The person on the other end of the phone won't know it's you.

The VOICE CHANGER is more than an "electronic handkerchief" — it doesn't cause your voice to sound filtered. It literally changes tone and timber.

Choose from two separate, distinct Changer Channels. If you're alone in a business office, it'll sound like an employee answering. If you live alone, you can get rid of pesky calls by pushing Channel 1 or Channel 2 and saying, "Sorry, that person isn't in."

How It Works

The VOICE CHANGER is powered by two ordinary penlight batteries. One set of lead-in wires connects to your telephone base; the other clips to the wires leading to the handset.

Pushing the button labeled "Ordinary" puts your normal voice through the line. Pushing "Channel 1" changes timber and texture. Pushing "Channel 2" creates different characteristics from Channel 1. Thus you have three voice options — your own, plus two changed voices.

MAKE NO MISTAKE! THE VOICE CHANGER DOESN'T MUFFLE YOUR VOICE OR MAKE IT UNINTELLIGIBLE. It literally changes the quality of sound — space-age electronics at work.

Use the VOICE CHANGER to reach that doctor, lawyer, or business executive whose secretary knows your voice and who always is "out" when you call. Use it to screen your own incoming calls. Use it for just plain fun. Any time you like, during a conversation, push the "Ordinary" button and your regular voice returns to the wire.

The VOICE CHANGER is yours for \$99.95 — two for \$89.95 each (plus \$2.50 shipping per total order). When you consider the many uses of this brilliant electronic instrument, it's a real bargain. Of course it has the standard New Horizons guarantee.

The Super Ear

You'll hear it all.

Effortlessly, you can hear not just a baby's cries, but quiet breathing — through a concrete wall a foot thick. Put the earphone in your ear and place the SUPER-EAR on the wall. That's all there is to it.

SUPER-EAR hears everything — and, even more astounding, hears it clearly. It's as though the wall weren't there. If you're coming home late at night and think intruders are in your residence, let SUPER-EAR find out for you. Want to know if the meeting is over in the room with the closed door? SUPER-EAR will tell you in a second.

SUPER-EAR is undetectable from the other side of the wall. The quality of sound has amazing fidelity — good enough to record, and SUPER-EAR has its own built-in recorder jack.

Because SUPER-EAR is the ultimate listening device, you can use it to pinpoint hidden squeaks in your car or the source of mysterious engine noises. Construction experts use it to check for flaws or cracks in buildings.

It Works Anywhere!

Ever put your ear to a railroad track to try to hear the train? Try it with SUPER-EAR. You'll hear that train many miles away. Use it as a powerful stethoscope on yourself, a friend, or a pet. You can even hear a bird's breathing.

The only source for SUPER-EAR is New Horizons. Choose from two models — Model SB-5, with ultrasensitive microphone, \$139.95 (two for only \$129.95 each); or Model SB-1, with suction-type microphone, \$99.95 (two for only \$89.95 each).

The Private Transmitter/Receiver

The NCZ-10 broadcasts on a special radio band. No one without special equipment can hear your transmitted messages.

The reception is unbelievably clear and bright — commercial broadcast quality.

Your receiver clicks into any of three separate channels. In the suburbs the range is up to 2000 feet, and in the city 850 feet.

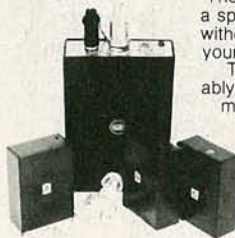

With your special receiver is an inconspicuous high fidelity earphone. You can put three transmitters in three locations and then switch back and forth, monitoring all three. Someone with an FM or police band receiver can tune his dial all day, but he won't pick up these signals.

With two receivers, you can have a complete two-way system without the inconvenience and annoyance of the semi-public CB channels. The NCZ-10 channels are private.

This professional-quality electronic miracle is easy to use and completely dependable. Monitor your baby's room. Leave a transmitter in an inconspicuous place in your office or your home, and you'll hear anything going on in that room.

One NCZ-10 receiver with one transmitter is \$279.95; with two transmitters (two separate bands), it's \$379.95; with three transmitters (three separate bands), it's \$479.95.

For a complete private communications system, order two receivers, each with a transmitter (we'll send them with different bands). Special high-performance batteries enable you to operate the receiver for 40 hours continuously, the transmitter for 35 hours.

We Absolutely Guarantee!

Use any electronic instrument acquired from us for up to 30 days. If you decide for any reason you don't want to keep it, return it for a 100% refund.

ORDER TOLL-FREE

For fast delivery on credit card orders, call toll-free 24 hours a day, seven days a week:

800-824-7888

Ask for Operator no. 551
(in California, call 800-852-7777)

Or send check or money order. Please add \$2.50 per total order for shipping. Order any or all these state-of-the-art electronic instruments:

- Dyna-Mike AR-7, \$129.95 (two for \$119.95 each)
- Dyna-Mike 9-DX, \$149.95 (two for \$139.95 each)
- 9-DX rechargeable power-pak, \$19.95
- Dyna-Mike A-5, \$99.95 (two for \$89.95 each)
- Super-Ear Model SB-5 microphone, \$139.95 (two for \$129.95 each)
- Super-Ear Model SB-1 microphone, \$99.95 (two for \$89.95 each)
- Voice Changer, \$99.95 (two for \$89.95 each)
- NCZ-10 transmitter and receiver, \$279.95 (two transmitters, one receiver, \$379.95) (three transmitters, one receiver \$479.95)

experience we've found that they get as many thermal problems, or even more. So, when you run into a set that shows symptoms of thermal problems, get out the spray coolant and the heat-gun and go after it. Use the methods outlined. They work, and can save you a lot of time and perspiration!

R-E

SERVICE QUESTIONS

WIDTH TOO WIDE

I have a problem with a CTC-68 RCA chassis. There is too much width, especially on the left side. The width control works, but not enough.—H.S., New York, NY

I suggested that he check the two 1.5 μ F capacitors from the horizontal yoke to ground. He wrote back and said that their values were right on the nose. However, experimenting, he found that using larger capacitors cleared up the problem. He settled for 5.7 μ F, and says that everything's fine.

RAIN MAKES SNOW

I have a satellite-TV receiving system that normally gives good reception. However, when it rains, it looks like I'm in a fringe area without a booster! I didn't think that rain was supposed to have any effect. All the components are good quality, or so I thought.—J.H. Pine Ridge, KY

Rain shouldn't usually have any effect. Try this: Sprinkle each component, especially the coax fittings, one at a time while watching the picture to see whether and when snow shows up. You could have a bad socket or plug, etc.

(Feedback: When I "rained" on the LNA, there came the snow! The coax fitting wasn't waterproof. The unit was still under warranty, so I exchanged it. Thanks!)

SMART SUBBING

I had a GE YA-E that kept blowing its horizontal amplifier, Q702. I found that two capacitors were shorted and leaking electrolyte, respectively. One, the .0075- μ F, 1600-volt capacitor was replaced. The other, a .01- μ F, 2400-volt device, was hard to find. The best that my local supply house could come up with was a .01- μ F disc rated at 3 KV. I didn't like to replace a tubular electrolytic with a disc, but I gambled on a Sprague "Safety Capacitor" type PP16S11S. That came up just right. The heat sink and Q702 stopped running hot, and everything's working fine. I must admit that I learned that trick from a "Service Clinic" back in 1979.

Thanks to Eric Urscher of Huntington, WV. Good work, Eric!

R-E

Radio-Electronics

mini-ADS

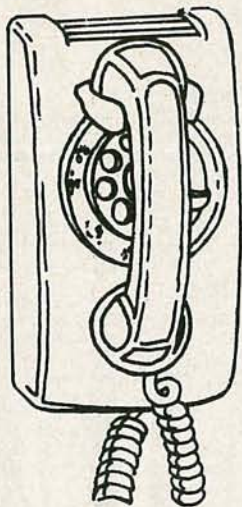

CALL NOW AND RESERVE YOUR SPACE

- 6 x rate \$550 per each insertion.
- Reaches 220,500 readers.
- Fast reader service cycle.
- Short lead time for the placement of ads.
- We typeset and layout the ad at no additional charge.

Call 212-777-6400 to reserve space. Ask for Arline Fishman. Limited number of pages available. Mail materials to: mini-ADS, RADIO-ELECTRONICS, 200 Park Ave. South, New York, NY 10003.

MONITORING TIMES A Bimonthly Newspaper

MONITORING TIMES is a bimonthly newspaper devoted to the interests of the radio hobbyist. It features articles on the latest in radio technology, including satellite TV, video, and computer graphics. The magazine is published by Grove Enterprises, Inc., and is available to subscribers for a nominal fee. The magazine is published twice a year, in January and July. It is a must-read for anyone interested in the latest in radio technology.

How can I intercept smugglers? Secret satellites? Rescue Missions? Signals from space? What is the truth about antennas? Tuners? Preampifiers? How can I choose the best receiver? Antenna? Uncover listening excitement you never thought possible! For your Free copy of MONITORING TIMES—CALL NOW! Toll-free 1-800/438-8155 (Cont. US except NC). Others dial 1-704/837-2216 or write Grove Enterprises, Dept. G, 140 Dog Branch Road, Brass-town, NC 28902.

CIRCLE 32 ON FREE INFORMATION CARD



APPLIANCE REPAIR HANDBOOKS—13 volumes by service experts; easy-to-understand diagrams, illustrations. For major appliances (air conditioners, refrigerators, washers, dryers, ranges, microwaves, etc.), elec. housewares, personal-care appliances. Basics of solid state, setting up shop, test instruments. \$3.65 to \$4.90 each. Free brochure. Appliance Service, P.O. Box 789, Lombard, IL 60148. 1-(312) 932-9550.

CIRCLE 39 ON FREE INFORMATION CARD

AMATEUR MICROWAVE RECEIVER



ONLY \$89.95 complete with the following

- * 75 to 300-ohm balun
- * balun for rabbit ears
- * 20" fiberglass parabolic dish
- * low noise probe/down converter
- * 60 ft. factory made coax
- * 3 ft. coax
- * power supply
- * mounting hardware and instructions.

All for only \$89.95 plus \$5.00 shipping & handling Visa, MasterCard or C.O.D. cash or certified check. NATIONWIDE G.H.Z., 6825 N. 16th St., Phoenix, AZ 85016 (602) 274-1199.

CIRCLE 33 ON FREE INFORMATION CARD



THE MEAN LITTLE KIT

New compact kit of electronic tools. Includes 7 screwdrivers, adjustable wrench, 2 pair pliers, wire stripper, knife, alignment tool, stainless rule, hex-key set, scissors, 2-flexible files, burnisher, soldering iron, solder aid, solder and desoldering braid. Highest quality padded zipper case. Send check or charge Bank-Americard, Mastercharge, or American Express. The *JTK-6* sells for **\$95.00**—Jensen Tools Inc., 7815 S. 46th Street Phoenix, Arizona 85040, (602) 968-6231.

CIRCLE 34 ON FREE INFORMATION CARD

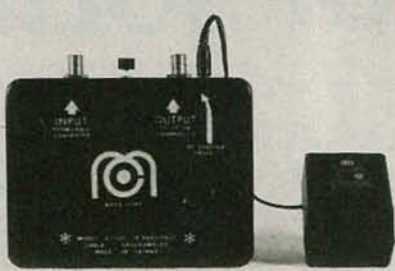

New Product - Computerized Addressable Cable T.V. Descrambler In/out Channel 3. Restores picture to normal Sync. Passes undistorted Audio signal. Kits **\$59.95** Wired and tested **\$119.95**. Check, money orders, C.o.d. only. Add 5% Shipping under \$100.00. *Quantity discounts.* Send \$2.00 for Complete catalog on Converters and unscramblers.

Mean Electronics

P.O. Box 347

Boston, Mass. 02188

CIRCLE 40 ON FREE INFORMATION CARD



MEASURES CAPACITORS AND DETECTS LEAKAGE

ANDERS CM-100A is a rugged battery powered portable instrument capable of measuring capacitors from 10pF to 500µF. The instrument can detect capacitor leakage of 1 na or .005 CV whichever is greater. Send check or money order for \$89.95 plus \$3.50 shipping and handling to: **Anders Precision Instrument Co.**, 4 Bridge St. Plaza, P.O. Box 75, Willimantic, CT 06226 or call (203) 423-7940.

CIRCLE 91 ON FREE INFORMATION CARD



TeleMatic's Update Kit (Model 10J107) modernizes older test jigs for servicing the increasingly wider range of today's TVs which require a test jig equipped with a selection of yoke matching values. The 10J107 allows quick selection of 9 horizontal and 5 vertical impedance values. Adapts most 19" test jigs. Sold through distributors only. For more information phone 212-271-5200, or write to: **TeleMatic, Division of U.X.L. Corp.**, 108-02 Otis Avenue, Corona, NY 11368.

CIRCLE 35 ON FREE INFORMATION CARD

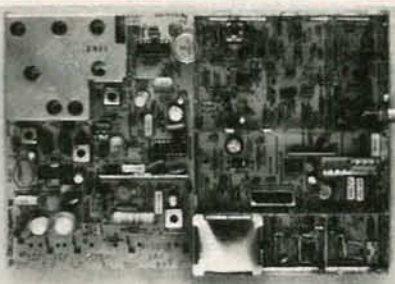

TELEVISION MODULE includes VHF, UHF, and CABLE-TV TUNERS, IF AMPLIFIER, VIDEO DETECTOR, SOUND DETECTOR and AMPLIFIER, and SYNC PROCESSOR: **\$85.00**. TELEVISION SIGNAL PROCESSING MANUAL explores standard and non-standard television: **\$15.95**. Add 5% handling and shipping. Catalog \$2.00. VISA and MC accepted. ORDER DESK (415) 439-7470. **ABEX, P.O. BOX 26601-RZ, SAN FRANCISCO, CA 94126.**

CIRCLE 38 ON FREE INFORMATION CARD

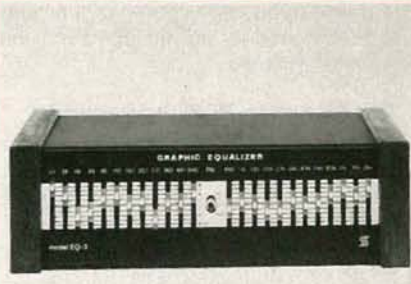

Still the best GRAPHIC EQUALIZER kit

- *See **Radio-Electronics** 5/78 cover story
- *12 bands/channel - *.02% distortion -
- *92dB S/N ratio - *Solid walnut ends -
- *Kit only \$100 postpaid via UPS

Free catalog full of audio kits

Symmetric Sound Systems (707) 546-3895

856G Lynn Rose Ct., Santa Rosa, CA 95404

CIRCLE 74 ON FREE INFORMATION CARD

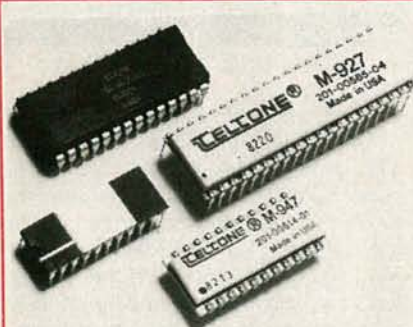

Turn telephones into control devices

Telphone offers 10 DTMF Receivers. The largest selection in the industry. With them you can turn the phone system into a control network. They outperform other receivers in noisy environments and operate over a wide dynamic range. For PABX's, radio-to-phone, computer, and peripheral interfaces specify Telphone DTMF Receivers. Call: 800/227-3800 X 1130. (In CA 800/792-0990 X 1130).

CIRCLE 84 ON FREE INFORMATION CARD

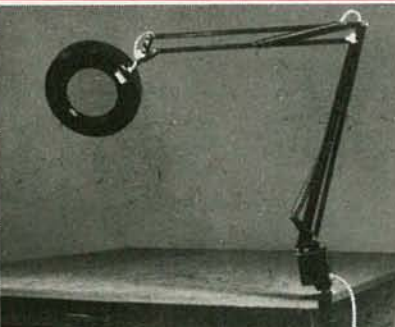

MAGNIFIER LAMP FOR LESS

All metal construction, UL approved 5", 3x magnifier, 22 watt fluorescent circline lamp. 45" arm reach, heavy duty clamp mount. **Only \$59.95** plus shipping. (California residents add sales tax.) To order call (800) 423-5336. In California, (800) 382-3663 or send **\$59.95** plus **\$5.00** shipping to **ORA ELECTRONICS, 18215 Parthenia St., Northridge, CA 91325 (213) 701-5848.**

CIRCLE 36 ON FREE INFORMATION CARD



SOLDERING STATION FOR LESS

Front display of tip temperature, adjustable temperature 200°F to 900°F. UL listed, low current leakage, high insulation. Complete as shown. 7 tips available, also takes standard tips. **ORDER MODEL XY-168. \$79.95** plus shipping. To order call toll free: (800) 423-5336. In California (800) 382-3663. Or send **\$79.95** (California residents add sales tax) plus **\$5.00**, shipping to **ORA ELECTRONICS DEPT. RE, 18215 Parthenia St., Northridge, CA 91325 (213) 701-5848.**

CIRCLE 93 ON FREE INFORMATION CARD

STATE OF SOLID STATE

Compressors, expanders, and companders

ROBERT F. SCOTT, SEMICONDUCTOR EDITOR

SINCE THE EARLY DAYS OF HIGH-FIDELITY audio, engineers have worked to improve the realism and signal-to-noise ratio of both recorded and broadcast music. Recording engineers, however, often limit or compress the dynamic range, and broadcasters limit or compress the signal amplitude, of that music. That is done to prevent overloading a tape or overcutting a record, and to prevent overmodulation. However, those same efforts cause the full dynamic range of the original music to be lost to you—if your playback system does not include a *dynamic volume expander*.

The Signetics NE570 compander

You can build a professional-quality expander, compressor, or compander (a combination compressor and expander circuit) for your hi-fi system by using circuits designed around the Signetics NE570 IC compander. The pin-out of the IC is shown in Fig. 1. As a compressor, the device provides a 2:1 compression ratio—for example, a 100-dB dynamic range of +20 dB to -80 dB is com-

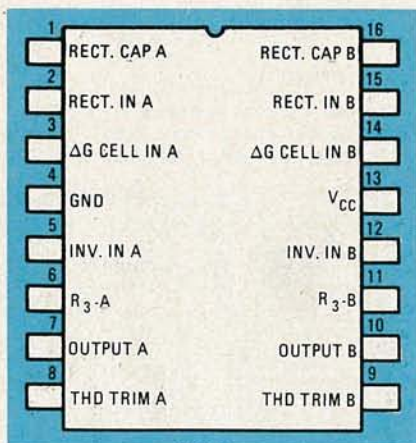

FIG. 1

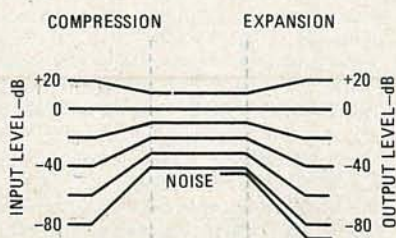

FIG. 2

pressed into a 50-dB (+10 to -40 dB) range as shown in Fig. 2. As an expander, it has a 1:2 expansion ratio, taking the +10 to -40 dB compressed signal and restoring its original full dynamic range.

A compander can be used for noise reduction. In that application, the signal is compressed before noise can be introduced, and expanded afterwards. Figure 2 shows how that method of companding (compressing and then expanding) can improve the signal-to-noise ratio by about 45 dB.

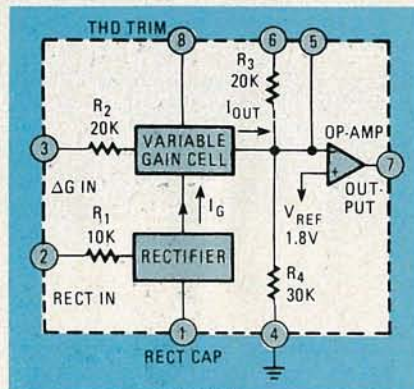

FIG. 3

A block diagram of one half of the NE570 is shown in Fig. 3. Each half of the IC consists of a full-wave rectifier, a variable-gain cell (ΔG), an op-amp, and a biasing system. The full-wave rectifier and an external capacitor (tied to the RECT CAP terminal) detect the average value of the input signal. The rectifier output current (I_G) controls the gain of the variable-gain cell. Therefore, the gain of that section of the circuit is proportional to the average value of the input-signal voltage. The ΔG output current, I_{OUT} , is fed to the inverting input of an on-chip op-amp that is biased at V_{REF} . That reference voltage is 1.8 volts and is provided by a very stable internal low-noise source. (That internal precision voltage-source also biases the THD TRIM circuit used for temperature compensation.)

The speed with which the circuit gain can follow changes in the amplitude of the input signal depends on the value of the external capacitor (the one attached to the RECT CAP terminal). A small capacitor will provide fast attack and fast decay times, but may not provide enough low-frequency filtering. In that case, residual

low-frequency signal components will appear on I_G and will modulate the signal passing through the variable-gain stage. That results in third-harmonic distortion, so there must be a compromise between fast response and distortion.

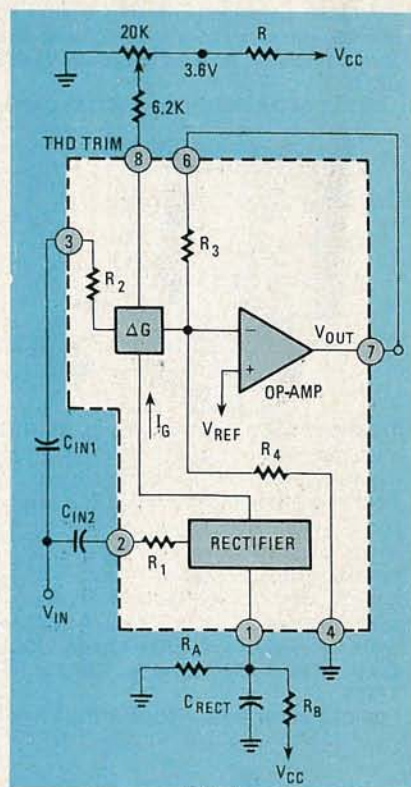

FIG. 4

The expander's output is determined by the DC gain provided by the op-amp. The output is related to the internal reference voltage and also to biasing resistors R_3 and R_4 as expressed by the equation: $V_{DC OUT} = (1 + R_3/R_4) V_{REF}$. When V_{CC} (the supply voltage) is higher than 6 volts, R_4 should be shunted with an external resistor to bias the output up to $1/2 V_{CC}$.

Resistor R_3 is brought out from the op-amp summing node and is used when you want expander or compressor gain to be set solely by on-chip components. You can adjust that gain to your needs by placing external resistors in series with R_3 . You can also connect an external resistor across R_4 to change the bias to any value desired.

The basic expander

Figure 4 shows the circuit of a basic expander. Input signal V_{IN} is applied to the rectifier and ΔG stage inputs in parallel. The expander can handle a signal input up to 3 volts peak. Rectifier input current can be as high as 300 μA , while the input to the ΔG stage should be limited to 140 μA . If the compandor will see input signals greater than +2.8-volts

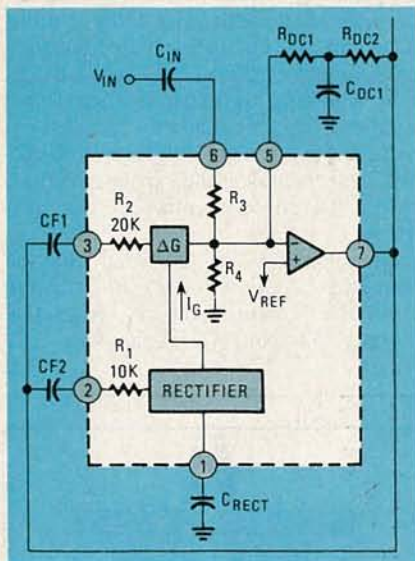

FIG. 5

peak, use suitable resistors in series with R_1 and R_2 to limit currents to the specified values.

Voltage offsets in the ΔG stage can cause distortion; primarily even harmonics. The THD TRIM pin permits a compensating external voltage to be applied to neutralize the effect of the offset voltages. A voltage divider composed of a 20K pot and series resistor R is connected between V_{CC} and ground as shown in Fig. 4. A 6.2K resistor is connected to the THD TRIM pin. The value of resistor R is selected to develop 3.6 volts at the high end of the pot.

In Fig. 4 coupling capacitors are shown in series with both the rectifier and ΔG stage inputs. However, R_1 and R_2 can be tied together and connected to the signal input through a single coupling capacitor. In that case, though, tracking at low input-signal levels will be degraded.

The comparator transfer-tracking tends to be a linear 2:1 ratio down to a very low input-signal level. Then, tracking may deviate in either direction from the normal 2:1. Either resistor R_A or R_B (but not both) may be needed to adjust transfer linearity. To correct low-level tracking error, select a suitable value for R_A ranging from around 1 megohm to 100K or for R_B between 250K and 5 megohms.

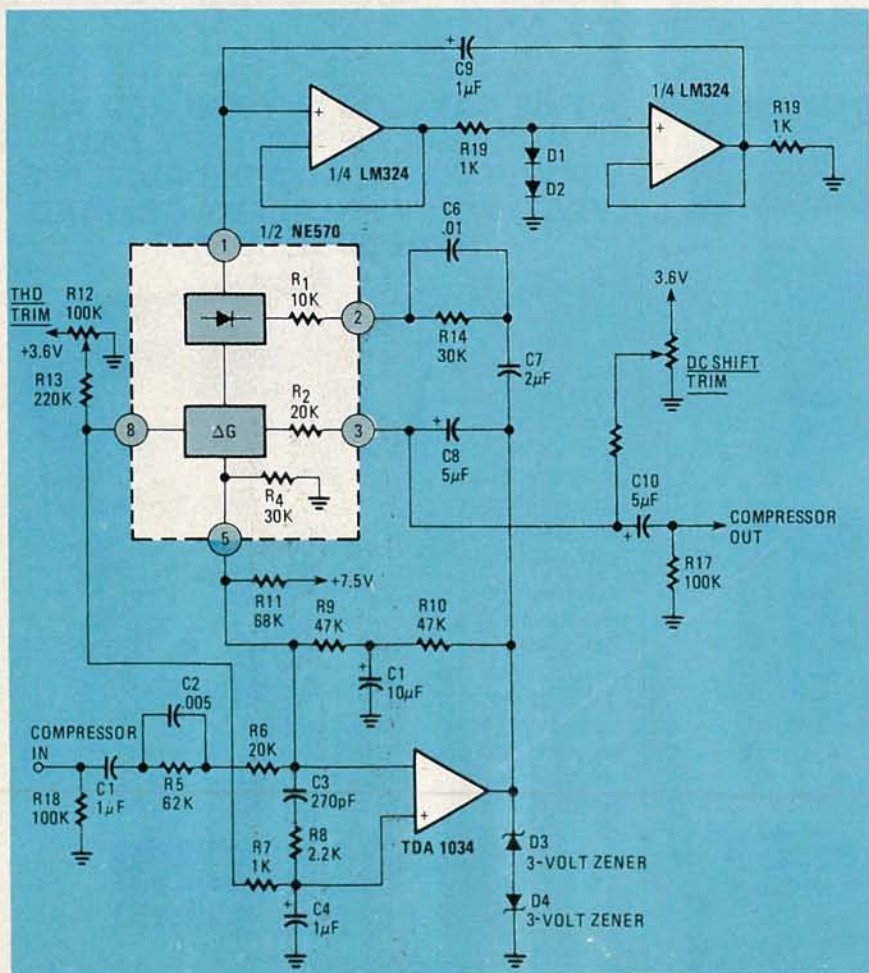

FIG. 6

SEE YOUR DEALER TODAY

FROM

Firestik®
ANTENNAS
ACCESSORIES

HERE'S A TIP
THAT'S PERFECT!

AM/FM AUTO RADIO
AND CB

'Firestik® II
GOLDEN SERIES

BARE-HANDS TUNABLE
"NO TOOLS NEEDED"
HIGH PERFORMANCE ANTENNAS

ALSO ANTENNAS FOR
CORDLESS TELEPHONES
MONITOR SCANNERS

Dealer & Distributor Inquiries Invited
SEND FOR FREE CATALOG

Firestik® Antenna Company
2614 East Adams/Phoenix, AZ 85034

Name _____
Street _____
City _____
State _____ Zip _____

Serving the CB and
Communications Market Since 1962.

5-YEAR REPLACEMENT WARRANTY

CIRCLE 27 ON FREE INFORMATION CARD

2 NEW
OPTO DESIGN KITS!

Now you can have 36 different options for easy LED design right at your finger tips!

Opto Designer I Opto Designer II

180 T-1 and T-1½
Red, Green, Yellow, Orange
and Red-Orange LED Lamps
\$19.95

180 Round, Square,
Triangular, Rectangular
and Cylindrical LED Lamps
\$24.95

Send for **FREE LED BROCHURE:**
• 3 mm (T-1) 5mm (T-1½) • Round • Square
• Cylindrical • Triangular • Rectangular • High
Intensity • Custom • Arrays • Two-color Round,
Rectangular • Level meter panel displays

**FREE 100 CB-50 T-1½ mounting
Clips** if you order within 7 days

ETRONIX 14803 NE 40th Street, Dept. RE033
Redmond, WA 98052

YES, I would like to take advantage of your offer.

- Send me — Opto Designer I @ \$19.95 plus
\$3.00 shipping and handling.
- Send me — Opto Designer II @ \$24.95 plus
\$3.00 shipping and handling.

Name _____
Address _____
Company _____
City _____ St. _____ Zip _____
Signature _____
Please charge my Mastercard Visa
No. _____ Exp. _____

CALL TOLL FREE 1-800-426-1044

CIRCLE 31 ON FREE INFORMATION CARD

The basic compressor

Figure 5 shows that the dynamic compressor is essentially an expander inserted in the feedback loop of an op-amp. The inputs of the ΔG stage and the rectifier are tied to the op-amp output. The variable-gain stage is set to provide AC feedback only; DC feedback is provided by an external low-pass network composed of R_{DC1} , R_{DC2} , and C_{DC1} . The sum of the values of the two feedback resistors determines the bias at the op-amp's output. The output voltage $V_{DC OUT}$ can be written:

$$V_{DC OUT} = 1 + \frac{R_{DC1} + R_{DC2}}{R_4} V_{REF}$$

$$= \left(1 + \frac{R_{DC TOT}}{30K}\right) 1.8V$$

When internal bias resistors R_3 and R_4 are used alone, the expander output will be:

$$V_{DC OUT} = 1 + \frac{R_3}{R_4} V_{REF}$$

$$= \left(1 + \frac{20K}{30K}\right) 1.8V = 3.0V$$

You can shunt a suitable resistor across R_4 to raise the output bias to the desired level; and you can connect a resistor in series with R_3 to increase op-amp output gain.

For the widest possible dynamic range, the compressor's output-level should be as high as possible. Therefore, the input

to the rectifier should be as high as possible without exceeding the $+300 \mu A$ peak-current limit. If the average input-signal level is low, a higher output can be obtained by using a shunt resistor to reduce the effective value of R_3 or by using an external series resistor to increase the effective value of R_2 . Note well that a reduction in the effective value of R_3 reduces the circuit's input impedance.

A high-fidelity compressor

Figure 6 shows a circuit for a hi-fi dynamic compressor that would make an ideal accessory for your tape-recording setup. It features high gain and wide bandwidth. Its external rectifier-capacitor (C_9) is not grounded. Instead, it is connected to the output of an op-amp network (IC1-a and IC1-b) to shorten the compressor attack-time at low signal-levels. (The attack time of the basic circuits in Figs. 4 and 5 is relatively long.) That external op-amp is used to provide improved high-frequency gain.

Diode D_3 and D_4 clamp the compressor output to a 7-volt peak-to-peak swing. That is necessary at times when the compressor is operating near maximum gain—as with a small signal input—and is suddenly hit with a high-level signal. Normally, the output would swing from V_{CC} to ground and would overload the circuit the compressor was feeding—a tape recorder for example.

The attack time and the time it takes for the compressor to recover from an overload depend on the value of C_9 . A value of about $1 \mu F$ is a good compromise.

Breathing

Even some of the best broadcast-quality compressors have been said to have a problem with *breathing*. That term refers to slow cyclic variations in background level that can be heard as the compressor changes gain. Breathing is minimized in this circuit by high-frequency pre-emphasis networks C_2 - R_5 and C_8 - R_{14} . Naturally, the expander should have a de-emphasis network to complement the compressor's pre-emphasis network. We'll take a look at the expander circuit, before we go on to other things, next month.

This material was abstracted from the Signetics *Comandor Product Guide* from the Analog Division, Signetics Corp., PO Box 409, Sunnyvale, CA 94086. R-E



HIGH BLOOD PRESSURE.
Treat it...and live.

The National High Blood Pressure Education Program,
U.S. Department of Health, Education, and Welfare.

AMATEUR MICROWAVE TV ANTENNA THE BEST FOR LESS!

M-21 SYSTEM FEATURES

Very High Gain System.
36" Parabolic Antenna
Microwave Downconverter
enclosed in aluminum
die-cast case
Antennas only \$40.00.
\$135.00 Single/\$115.00 4 Lot

TITAN II SYSTEM FEATURES

High Gain System.
22" Parabolic Antenna
Microwave Downconverter
enclosed in probe
\$70.00 Single/\$60.00 5 Lot

M-21 & T-2 Systems
come complete with:
Power Supply & Coax
Amateur Microwave Systems
not available to Michigan Residents.



COMPLETE SATELLITE RECEIVING SYSTEMS
from \$1695.00 Dealer inquiries invited.

PETE'S ELECTRONIC SERVICE & SUPPLY
33117 Gratiot • Mt. Clemens, MI 48043
(313) 791-5551
MASTERCARD • VISA • C.O.D. Accepted

CIRCLE 71 ON FREE INFORMATION CARD

THIS CATALOG IS YOUR KEY TO INCREASED EFFICIENCY AND PRODUCTIVITY. AND BECAUSE IT'S FREE, YOU'VE ALREADY STARTED TO REDUCE COSTS!

This is our current catalog... The Wire Handlers. It's filled with wire handling tools designed and engineered to make your life easier. The tools are unique... unique in design, and unique in the way they perform.

You may know about our Wire Strippers...but we also offer the finest power electric desoldering tools, termination kits, wire and cable cutters, slitters, crimpers, and low cost voltage testers, available. Ask for your copy of The Wire Handlers today! Just send your business card.



 **PALADIN CORPORATION**

Suite 106, 31332 Via Colinas, Westlake Village, CA 91362
Call (213) 991-4970.

CIRCLE 23 ON FREE INFORMATION CARD

JAPANESE SEMICONDUCTORS

SANYO
STK-435

\$4¹⁰



SANYO
STK-437

\$6⁵⁰



ZENER DIODE KIT
ZDK-23
Most popular zener diodes in kit of 23
Plastic Cabinet

\$11⁹⁵



SANYO



2SC1308K
\$1⁹⁹

TOSHIBA



2SC1172B
\$1⁹⁹

| | | | | | | | | | | |
|-------------|------------|--------------|-------------|-------------|------------|--------------|---------------|---------------|---------------|--------------------|
| TRANSISTORS | A808 3.18 | B697 3.23 | C789 1.20 | C1212A 58 | C1959 30 | D470A 2.51 | HA1138 1.36 | STK0029 3.88 | TA7222AP 1.87 | UPC1185H 3.11 |
| 2SA329 32 | A840 1.44 | 2SC352A 2.73 | C799 1.50 | C1213 18 | C1973 81 | D471 25 | HA1151 1.62 | STK0050 5.87 | TA7227PK 4.04 | UPC1186H 1.56 |
| A473 56 | A908 10.47 | C371 32 | C829 14 | C1215 28 | C2028 58 | D525 90 | HA1156W 1.26 | STK0080 10.60 | TA7310P 1.02 | UPC2002 1.43 |
| A483 3.07 | A909 10.51 | C372 16 | C830H 2.21 | C1226A 40 | C2029 1.53 | D526 81 | HA1196 1.36 | STK013 7.70 | TC4081P 5.08 | UPC14305 1.74 |
| A489 1.54 | 2S822 25 | C380A 14 | C838 36 | C1239 1.50 | C2074 97 | D555 4.51 | HA1197 1.28 | STK015 3.20 | TC5080P 5.42 | UPD8857 6.50 |
| A495 16 | B173 32 | C382 40 | C840 1.62 | C839 20 | C2166 97 | D588A 1.10 | HA1199 1.43 | STK032 7.65 | TC5081P 2.19 | UPD858 6.50 |
| A496 45 | B202 1.04 | C383 46 | C867A 2.80 | C1306 97 | 25D247 80 | D588A 1.71 | HA1201 76 | STK040 7.42 | TC5082P 3.19 | UPD861C 5.87 |
| A509 36 | B220 1.00 | C387A 34 | C895 5.09 | C1307 1.72 | D72 65 | D600 45 | HA1202 94 | STK043 8.80 | UHC001 4.07 | DIODES |
| A545 41 | B257 32 | C388A 52 | C900 20 | C1316 3.40 | D92 1.86 | D613 60 | HA1306W 2.08 | STK076 7.75 | UHC003 4.07 | GH3F 89 |
| A606 1.99 | B303 32 | C394 18 | C941 25 | C1318 18 | D157 2.51 | D623 94 | HA1319 2.75 | STK080 7.85 | UHC004 4.07 | SD200 15 |
| A607 1.28 | B324 36 | C458 14 | C945 11 | C1330 53 | D180 1.89 | D633 80 | HA1339A 1.84 | STK433 4.50 | UHC005 4.07 | IN60 14/100 |
| A626 3.86 | B367 1.85 | C486 1.99 | C959 1.17 | C1345 16 | D187 2.03 | 25K19 45 | HA1342A 1.84 | STK435 4.10 | UPC157A 2.19 | IN4002 12/100 |
| A627 2.03 | B407 1.22 | C495 52 | C960 1.10 | C1346 43 | D201 2.49 | 25K35A 34 | HA1361 2.08 | STK437 6.50 | UPC554C 2.15 | IN4003 12/100 |
| A634 6.4 | B426 1.22 | C496 45 | C1012 1.36 | C1364 25 | D226A 1.43 | 25K45 76 | HA1366W 1.89 | STK438 6.80 | UPC555H 4.5 | IN4004 12/100 |
| A651 36 | B448 1.72 | C497 1.56 | C1025 90 | C1383 27 | D234 82 | IC | HA1366W 1.89 | STK443 6.80 | UPC571C 2.44 | IN4005 15/100 |
| A662 50 | B474 1.12 | C509 32 | C1034 5.60 | C1384 29 | D235 82 | AN214Q 1.50 | HA1377 2.93 | STK502 7.50 | UPC575C 1.10 | IN4006 16/100 |
| A684 32 | B507 60 | C517 4.40 | C1047 1.8 | C1403A 3.21 | D278A 2.97 | AN239 5.43 | HA1398 4.22 | STK503 7.50 | UPC576H 3.18 | IN4007 20/100 |
| A699A 64 | B509 2.15 | C537 16 | C1050 1.71 | C1413A 4.97 | D313 45 | AN247 2.99 | LA1365 1.26 | TA7055P 1.99 | UPC577H 72 | SILICONE |
| A705 58 | B511 64 | C563 63 | C1061 5.6 | C1419 5.6 | D315 1.02 | AN274 2.25 | LA3350 1.10 | TA7060P 70 | UPC592H 52 | RECTIFIER |
| A706 1.26 | B528 66 | C627 1.28 | C1096 40 | C1448 1.20 | D350 3.99 | AN313 2.79 | LA4032P 1.66 | TA7061AP 90 | UPC1001H 2.89 | 2.5 Amp-1000 Volts |
| A719 20 | B529 66 | C642A 3.86 | C1114 3.45 | C1567A 56 | D353 2.82 | AN315 2.90 | LA4400 1.80 | TA7062 56 | UPC1006C 2.84 | SL 100 10/100 |
| A722 20 | B536 90 | C696 1.36 | C1115 4.06 | C1664A 2.00 | D357 61 | AN362 1.41 | LA4430 1.36 | TA7074P 2.05 | UPC1016C 2.44 | |
| A738 43 | B537 90 | C708 1.51 | C1116A 4.13 | C1167A 1.4 | D358 66 | AN374 99 | M51513L 1.69 | TA7075P 2.05 | UPC1020H 2.89 | |
| A740 2.35 | B541 2.77 | C710 16 | C1124 99 | C1678 1.05 | D381 76 | AN375 1.35 | M51515BL 3.05 | TA7076P 3.39 | UPC1025H 4.06 | |
| A743A 6.64 | B555 3.09 | C732 14 | C1127 1.90 | C1726 81 | D386A 79 | AN7145 2.46 | MB3705 1.54 | TA7120P 58 | UPC1029C 88 | |
| A747 7.02 | B556 5.35 | C733 14 | C1161 1.95 | C1760 82 | D424 3.03 | AN7150 2.33 | MB3712 1.51 | TA7130P 97 | UPC1033H 72 | |
| A747A 7.50 | B557 2.93 | C735 28 | C1166 50 | C1815 11 | D425 3.03 | BAS11A 1.44 | MB3730 3.18 | TA7201P 1.03 | UPC1154H 2.43 | |
| A748 9.2 | B561 1.8 | C756A 1.40 | C1169 5.69 | C1816 2.26 | D426 2.89 | BAS12 1.33 | MB3756 1.98 | TA7203P 2.30 | UPC1155H 1.69 | |
| A752 14 | B565 1.24 | C781 1.89 | C1172B 1.99 | C1819 5.6 | D438 34 | BAS32 1.62 | MBB719 4.78 | TA7204P 1.35 | UPC1156H 1.89 | |
| A762 4.15 | B617A 1.36 | C784 28 | C1173 52 | C1904 36 | D467 16 | BA1310 1.56 | PLL01A 3.66 | TA7205AP 1.21 | UPC1181H 1.28 | |
| A771 2.08 | B656A 3.84 | C785 28 | C1209 28 | C1951 1.44 | D468 16 | HA1337W 1.12 | PLL02A 6.34 | TA7214P 3.40 | UPC1182H 1.28 | |

OMNITRON

ELECTRONICS
770 Amsterdam Ave., New York, NY 10025

▶ Also ask for Free 100 Page Catalog ◀

Send Purchase Order, Check or Money Order
or Call Toll Free 800-223-0826

in NY STATE (212) 865-5580
All ORDERS SHIPPED UPS/COD F.O.B., N.Y.C.

MASTER CARD • VISA

CIRCLE 68 ON FREE INFORMATION CARD

2300 MHz VARIABLE DOWN CONVERTER

ANTENNA KIT

\$16⁹⁵

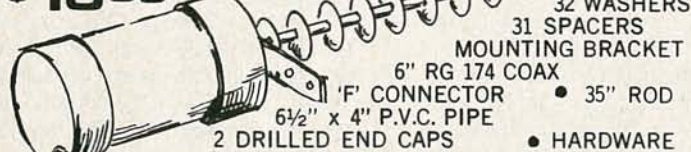

32 WASHERS
31 SPACERS
MOUNTING BRACKET
6" RG 174 COAX
'F' CONNECTOR
6 1/2" x 4" P.V.C. PIPE
2 DRILLED END CAPS
35" ROD
HARDWARE

POWER SUPPLY KIT

\$16⁹⁵



POWER TRANSFORMER
COURSE TUNE POT.
FINE TUNE POT.
3 'F' CONNECTORS
RESISTORS & CAPS
LED WITH HOLDER
TERMINAL STRIP

P.C. BOARD
RF CHOKE
KNOB
WIRE
2 SWITCHES
4 DIODES
LM 317 REG.

WOOD GRAIN CABINET WITH SILK
SCREENED front and back \$10.95 Extra

BUILT POWER SUPPLY.....\$34.95

Complete
Down Converter
System
INCLUDES
ANTENNA KIT
POWER SUPPLY KIT
CONVERTER KIT
SPECIAL \$49.95

QUANTITY DISCOUNTS
Any Price in Adv.
10 pcs. 12% off
25 pcs. 18% off
50 pcs. 25% off
100 pcs. 30% off
1000 pcs. 35% off

No Mixing for
Quantity Discount

PARTS

Converter P.C. Board
Plated through holes
for stability.....\$4.95
Power Supply
P.C. Board2.95
MRF 9012.00
NEO21354.95
2835 Diodes95
.001 Chip
Caps. 10/3.95
Choke Set of 4.....1.95
LM 317 Regulator 1.25
'F' Connectors
Chassis50
Wall Transformer
12 VAC 700 MA....4.95
'U' Bolt95
BALUN
75 to 300 ohm.....1.95
BALUN
for rabbit ears....2.95
*RG 59/U COAX
WITH CONNECTORS
FACTORY MADE
100 Ft.\$17.50
50 Ft. 9.50
25 Ft. 5.75
3 Ft. 2.50

CONVERTER KIT

\$16⁹⁵



P.C. BOARD PRE-DRILLED
SOLDER PLATED WITH
PLATED THROUGH HOLES
FOR A MORE STABLE PIC-
TURE.

NEW!!
2137 HOT TRANS...
3 MRF 901 TRANSISTOR
2 HP 2835 Diodes
6 .001 Chip Caps.
9 Resistors
4 Prewound chokes
1 Electrolytic Cap.
1 Pre Made Probe

★ WIRED P.C. BOARD TEST-
ED, READY TO CONNECT TO
CAN WITH PROBE & CABLE
CONNECTOR ATTACHED.
\$24.95

We will tune conver-
ter board for \$12.50
trouble shoot
add7.50
trouble shoot
power supply..\$12.50
plus any parts needed.

We will accept telephone orders for Visa & Mastercard
No C.O.D. Orders

To Order Call 800-428-3500 317-291-7262
Complete Kit Weighs 10 pounds. Please add Sufficient Postage
6254 La Pas Trail
Indianapolis, Indiana 46268

ELECTRONIC RAINBOW

CIRCLE 87 ON FREE INFORMATION CARD

COMPUTER CORNER

Choosing a printer

LES SPINDLE*

OF ALL THE PERIPHERALS THAT YOU WILL select as you assemble a complete computer system, a printer may at first seem to be the least necessary. You can still manipulate data and perform almost all the functions you want to by accessing data from the CRT screen. But sooner or later—especially in a business environment—you will want printed records of your computer transactions.

You may want to print invoices, statements, or mailing labels. You may want to send out form letters—or simply handle regular correspondence more conveniently. Or, you may simply need to share the computer's output with a number of people who need to have access to the information. How do you go about selecting the printer that is best for your needs?

Printer prices can range from about \$200 up to \$4000 or more. You'll be surprised to learn that an adequate printer will, in many cases, actually cost more than the computer itself. As in all computer-product purchases, you will need to analyze your specific requirements to find the printer that will provide the most cost-effective solution for you.

Printers used with microcomputers fall into two categories: dot-matrix and impact. Dot-matrix printers press small "hammers" against the paper through a ribbon, making patterns of dots that form the characters. Impact printers, which produce solid "letter-quality" type, usually fall into two major categories: ball-type (similar to the IBM *Selectric*) and daisy-wheel.

Dot-matrix printers

Dot-matrix printers are fine for routine office paperwork, file reports, or informal documents. They are not generally considered good enough for generating professional-looking correspondence, however, or for documents that need to be photocopied. If your office generates a lot of correspondence, you may well want an impact printer (see below). Many users, though, are drawn to dot-matrix printers because they offer very fast speed at a reasonable cost. Many print 132 columns (characters-per-line) at 120–180 characters-per-second, although some recent models offer even higher speeds. A

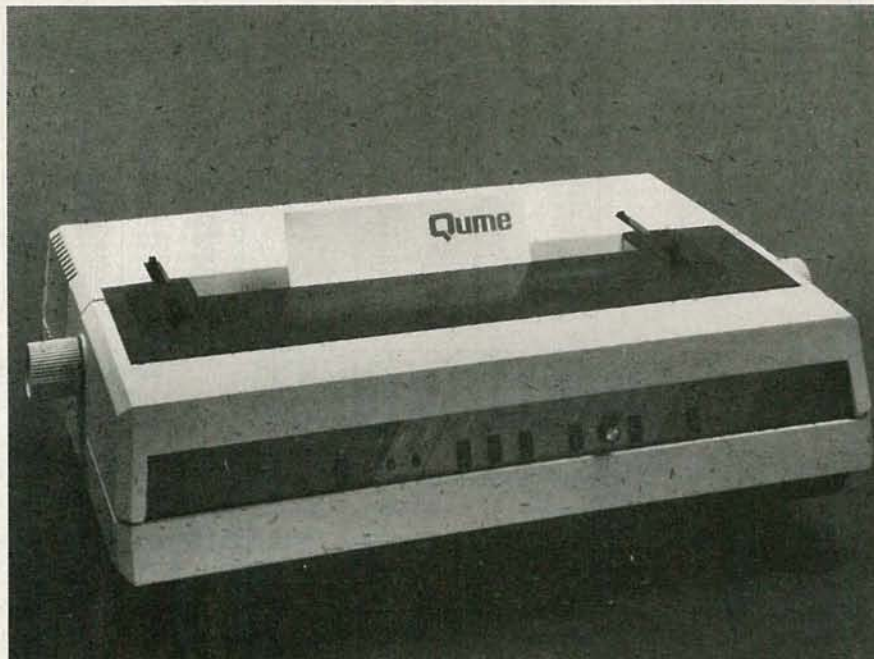

FIG. 1

typical dot-matrix printer might cost \$500–1000.

What features should you look for in a dot-matrix printer? The first criterion, of course, is print quality. Although dot-matrix-formed characters, almost without exception, are inferior to those produced by impact printers, some dot-matrix printers produce better-quality output than others.

One very important factor to consider is whether the characters have *descenders*. Descenders are the portions of lowercase letters like "j," "g," and "y" that are printed "below the line." If there are no descenders, some characters will look "scrunched-up," and it may be difficult to tell the difference between, say, a "g" and an "s."

You will also want to check the unit's method of feeding paper. Some units accept single sheets, like letterhead, readily, while others can't. Many printers can use only continuous-form paper with sprocket holes.

Impact printers

Impact printers vary widely in type and quality. It is important to understand all of the variables involved in order to make the appropriate choice.

Daisy-wheel printers use a print element shaped like a daisy. Each "petal" contains one character. The daisy-shaped wheel is rotated by a shaft, and, when the appropriate character is in position, its "petal" is struck by a hammer and an impression is made, through the ribbon, on the paper.

Most daisy-wheel printers operate at only 40–60 characters-per-second—considerably slower than most dot-matrix units. They are also somewhat noisy—as are all other impact printers—but in many cases specially-designed enclosures will solve that problem. (That is not to say that dot-matrix printers are silent—sometimes the lower-volume noise they produce can be more irritating than that made by impact printers.) You may want to consider the cost of a noise-reduction enclosure when you are doing your comparison shopping. Daisy-wheel printers range in price from about \$900 (for a 10-characters-per-second device) to over \$4000.

Several manufacturers offer a thimble-shaped print element instead of a daisy wheel; both systems work on the same principles. Ranging in price from \$2000 to \$4000, thimble printers, such as the one shown in Fig. 1, are praised by many

*Managing Editor, *Interface Age* magazine

FOR ONLY \$129.95 Learn Computing From The Ground Up

Build a Computer kit that grows with you, and can expand to 64k RAM, Microsoft BASIC, Text Editor/Assembler, Word Processor, Floppy Disks and more.

EXPLORER/85

Here's the low cost way to learn the fundamentals of computing. All important basics you'll need more and more as you advance in computer skills. For just \$129.95 you get the advanced design Explorer/85 motherboard with all the features you need to learn how to write and use programs. And it can grow into a system that is a match for any personal computer on the market. Look at these features: 8085 Central Processing Unit, the microprocessor heart of the Explorer/85 (join the millions who will buy and use the 8000/8085 this year alone!); Four 8-bit parallel bidirectional ports from which you can input or output programs as well as control exterior switches, lights, etc.; a cassette interface that lets you slow and reload programs you've learned to write; deluxe 2,000 byte operating system/monitor makes it easy to learn computing in several important ways; It allows simpler, faster writing and entering of programs; It permits access by you to all parts of the system so you can check on the status of any point in the program; It allows tracing each program step by step, with registers for displaying all the contents of the CPU (registers, flags, etc.) and it does much more!

You get all this in the starting level (Level A) of the Explorer/85 for only \$129.95. Incredible! To use, just plug in your TV/C, power supply and terminal or keyboard/display — if you don't have them see our special offers below.

Level A computer kit (Terminal Version) \$129.95 plus \$3 P&I*
Level A kit (Hex Keypad/Display Version) \$129.95 plus \$3 P&I*

LEVEL B — This "building block" converts the motherboard into a two-slot S100 bus (industry standard) computer. Now you can plug in any of the hundreds of S100 cards available.

Level B kit \$49.95 plus \$2 P&I*
S100 bus connectors (two required) \$4.85 each, postpaid.

LEVEL C — Add still more computing power; this "building block" mounts directly on the motherboard and expands the S100 bus to six slots.

Level C kit \$39.95 plus \$2 P&I*
S100 bus connectors (five required) \$4.85 each, postpaid.

LEVEL D — When you reach the point in learning that requires more memory, we offer two choices: either add 4k of a memory directly on the motherboard, or add 16k to 64k of memory by means of a single S100 card, our famous JAWS.

Level D kit (CHECK ONE) 4k on-board \$49.95 plus \$2 P&I* 16k S100 JAWS \$149.95 plus \$2 P&I* 32k S100 JAWS \$199.95 plus \$2 P&I* 48k S100 JAWS \$249.95 plus \$2 P&I* 64k S100 JAWS \$299.95 plus \$2 P&I*

LEVEL E — An important "building block" it activates the 8k ROM/EPROM space on the motherboard. Now just plug in our 8k Microsoft BASIC or your own custom programs.

Level E kit \$5.95 plus \$2 P&I*
8k ROM version of Microsoft BASIC (requires Level B & Level E and 4k RAM, just plug in your Level E socket \$2) \$99.95 plus \$2 P&I*
We suggest either the 4k Level D RAM expansion or a 16k S100 JAWS \$199.95 plus \$2 P&I*
Disk version of Microsoft BASIC (requires Level B & 32k of RAM, floppy disk controller, 8" floppy disk drive) \$325 postpaid.

TEXT EDITOR/ASSEMBLER — The editor/assembler is a software tool (a program) designed to simplify the task of writing programs. As your programs become longer and more complex, the assembler can save you many hours of programming time. This software includes an editor program that enters the programs you write, makes changes, and saves the programs on cassettes. The assembler performs the clerical task of translating symbolic code into the computer readable object code. The editor/assembler program is available either in cassette or a ROM version.

Editor/Assembler (Cassette version, requires Level B & 8k (min) of RAM — we suggest 16k JAWS — see above) \$59.95 plus \$2 P&I*
Editor/Assembler (ROM version, supplied on an S100 card, requires Level B and 4k RAM (min) — we suggest either Level D or 16k JAWS) \$99.95 plus \$2 P&I*

FLOPPY DISK — A remarkable "building block" Add our 8" floppy disk when you need faster operation, more convenient program storage, perhaps a business application, and access to the literally thousands of programs and program languages available today. You simply plug them into your Explorer/85 disk system — it accepts all IBM formatted CP/M programs.

8" Floppy Disk Drive \$499.95 plus \$12 P&I*
Floppy Controller Card \$199.95 plus \$2 P&I*
Disk Drive Cabinet & Power Supply \$69.95 plus \$3 P&I*
Drive Cables (set up for two drives) \$25.00 plus \$1.50 P&I*

CP/M 2.2 Disk Operating System, includes Text Editor/Assembler, dynamic debugger, and other features that give your Explorer/85 access to thousands of existing CP/M based programs \$150.00 postpaid.

NEED A POWER SUPPLY? Consider our AP-1. It can supply all the power you need for a fully expanded Explorer/85 (note: disk drives have their own power supply). Plus the AP-1 fits neatly into the attractive Explorer steel cabinet (see below).

AP-1 Power Supply kit (8V, 4 1/2 amp) in deluxe steel cabinet \$39.95 plus \$2 P&I*

NEED A TERMINAL? We offer you choices, the least expensive one is our Hex Keypad/Display kit that displays the information on a calculator-type screen. The other choice is our ASCII Keyboard/Computer Terminal kit that can be used with either



1. Plug in Netronics's Hex Keypad/Display
2. Add Level B to convert to S100
3. Add 4k RAM
4. Plug in Level E here, in cassette, Microsoft BASIC, or Keypad/Display
5. Add two S100 boards
6. Add your own custom CP/M software (postpaid, if needed)
7. Connect terminal

a CRT monitor or a TV set (if you have an RF modulator)
Hex Keypad/Display kit \$69.95 plus \$2 P&I*

FASTERM-64 TERMINAL KIT — Featuring a 56 key ASCII Keyboard, 128 character set upper and lower case, 75 ohm output, 8 baud rates, 150 to 19,200 (switch select) RS232-C or 20 MA (output 32 or 64 character by 16 line format), complete with Deluxe Steel Cabinet and Power Supply \$199.95 plus \$3 P&I*

RF Modulator kit (allows you to use your TV set as a monitor) \$8.95 postpaid

12" Video Monitor (10MHz bandwidth) \$139.95 plus \$5 P&I*

Deluxe Steel Cabinet for the Explorer/85 \$49.95 plus \$1 P&I*

Fan for cabinet \$15.00 plus \$1.50 P&I*



ORDER A SPECIAL-PRICE EXPLORER/85 PAK — THERE'S ONE FOR EVERY NEED.

Beginner Pak (Save \$26.00) — You get Level A (Terminal Version) with Monitor Source Listing (\$25 value), AP-1, 3-amp power supply, Intel 8085 Users Manual (Reg. \$199.95) SPECIAL \$169.95 plus \$4 P&I*

Experimenter Pak (Save \$53.40) — You get Level A (Hex Keypad/Display Version) with Hex Keypad/Display, Intel 8085 User Manual, Level A Hex Monitor Source Listing, and AP-1, 3-amp power supply (Reg. \$279.95) SPECIAL \$219.95 plus \$6 P&I*

Special Microsoft BASIC Pak (Save \$103.00) — You get Levels A (Terminal Version), B (D 4k RAM), E, 8k Microsoft in ROM, Intel 8085 User Manual, Level A Monitor Source Listing, and AP-1, 3-amp power supply (Reg. \$430.70) SPECIAL \$329.95 plus \$7 P&I*

Add a Rom Version Text Editor/Assembler (Requires Levels B and D or S100 Memory) \$99.95 plus \$2 P&I*

Starter B Disk System — Includes Level A, B floppy disk controller, one CDC B disk drive, two drive cables, two S100 connectors, just add your own power supplies, cabinets and hardware (Reg. \$1805.00) SPECIAL \$999.95 plus \$13 P&I* 32k Starter System \$1045.95 plus \$13 P&I* 64k Starter System \$1145.95 plus \$13 P&I*

Add to any of above Explorer steel cabinet, AP-1 five amp power supply, Level C with two S100 connectors, disk drive cabinet and power supply, two sub-D connectors for connecting your printer and terminal (Reg. \$249.95) SPECIAL \$199.95 plus \$13 P&I*
Complete 64k System (Wired & tested) \$1650.00 plus \$26 P&I*

Special Complete Business Software Pak (Save \$625.00) — Includes CP/M 2.2 Microsoft BASIC, General Ledger, Accounts Receivable, Accounts Payable, Payroll Package (Reg. \$1325) SPECIAL \$699.95 postpaid.

*P&I stands for "postage & insurance." For Canadian orders, double this amount.

Continental Credit Card Buyers Outside Connecticut:

TO ORDER
Call Toll Free:
800-243-7428

To Order From Connecticut, or For Technical Assistance, Call (203) 354-9375

CP/M is a reg. trademark of Digital Research

★ (Clip and mail entire ad) ★

SEND ME THE ITEMS CHECKED ABOVE

Total Enclosed (Conn. Residents add sales tax) \$
Paid by:

Personal Check Cashier's Check/Money Order

VISA MASTER CARD (Bank No. _____)

Acct. No. _____ Exp. Date _____

Signature _____

Print Name _____

Address _____

City _____

State _____ Zip _____

ANNOUNCING TWO NEW TERMINALS

Smart • Fast • Graphics • Matching Modem and \$295 Printer

Netronics announces a state of the art breakthrough in terminals, now at prices you can afford, you can go on-line with data bank and computer phone-line services. It's all yours: "electronic newspapers," educational services, Dow Jones stock reports, games, reports, personal computing with any level language, program exchanges, electronic bulletin boards... and more every day!!!



Netronics offers two new terminals, both feature a full 56 key/128 character rewriter-style keyboard, baud rates to 19.2 kilobaud, a rugged steel cabinet and power supply. The simplest one, FASTERM-64, is a 16 line by 64 or 32 character per line unit, with a serial printer port for making hard copy of all incoming data, and optional provisions for block and special character graphics. The "smart" version, SMARTERM-80, features either 24 line by 80 characters per line or 16 by 40 characters per line. It offers on-screen editing with page-at-a-time printing, 12,000 pixel graphics, line graphics, absolute cursor addressing, underlining, reverse video, one-half intensity and much more... simply plug them into your computer or our phone modem and be on-line instantly. Use your TV set (RF modulator required) or our deluxe green-phosphor monitor pictured above. For hard copy just add our matched printer.

Price breakthrough!!! Own the FASTERM-64, a complete terminal kit, ready to plug in for just \$199.95 or order the SMARTERM-80 kit for just \$299.95, (both available wired and tested.) Be on-line with the million-dollar computers and data services today... we even supply the necessary subscription forms.

More good news. All the components in our terminals are available separately (see FASTERM-64, so you buy only what you need!!!)

FASTERM-64... DISPLAY FORMAT: 64 or 32 characters/line by 16 lines... 96 displayable ASCII characters (upper & lower case)... 8 baud rates: 150, 300, 600, 1200, 2400, 4800, 9600, 19, 200 (switch sel)... LINE OUTPUT: RS232C or 20 ma current loop... VIDEO OUTPUT: 1V P/P (EIA RS-170)... CURSOR MODES: home & clear screen, erase to end of line, erase cursor line, cursor up & down, auto carriage return/line feed at end of line & auto scrolling... REVERSE VIDEO... BLINKING CURSOR... PARITY: off, even or odd... STOP BITS: 1, 1.5, 2... DATA BITS PER CHARACTER: 5, 6, 7 or 8... CHARACTER OUTPUT: 5 by 7 dot matrix in a 7 by 12 cell... PRINTER OUTPUT: prints all incoming data... 1K ON BOARD RAM... 2K ON BOARD ROM... CRYSTAL CONTROLLED... COMPLETE WITH POWER SUPPLY... OPTIONAL GRAPHICS MODE: includes 34 Greek & math characters plus 30 special graphics characters... ASCII ENCODED KEYBOARD: 56 key/128 characters... SMARTERM-80... DISPLAY FORMAT: 80 characters by 24 lines or 40 characters by 16 lines... 128 displayable ASCII characters (upper & lower case) 8 baud rates: 110, 300, 600, 1200, 2400, 4800, 9600, 19, 200... LINE OUTPUT: RS232C or 20 ma current loop... VIDEO OUTPUT: 1V pp (EIA RS-170)... EDITING FEATURES: insert/delete line, insert/delete character, forward/back tab... LINE OR PAGE TRANSMIT... PAGE PRINT FUNCTION... CURSOR POSITIONING: up, down, right, left, plus absolute cursor positioning with read-back... VISUAL ATTRIBUTES: underline, blink, reverse video, half intensity, & blank... GRAPHICS: 12,000 pixel resolution block plus line graphics... ON-SCREEN PARITY INDICATOR... PARITY: off, even or odd... STOP BITS: 110 baud 2, all others 1... CHAR. OUTPUT: 7 by 11 character in a 9 by 12 block... PRINTER OUTPUT... 60 OR 50 Hz VERTICAL REFRESH... BLINKING BLOCK CURSOR... CRYSTAL CONTROLLED... 2K ON BOARD RAM... ASCII ENCODED KEYBOARD: 56 key/128 character... 4K ON BOARD ROM... COMPLETE WITH POWER SUPPLY.

TELEPHONE MODEM 103 O/A... FULL DUPLEX, FCC APPROVED... DATA RATE: 300 baud... INTERFACE: RS232C and TTY... CONTROLS: talk/data switch (no need to connect and disconnect phone), originate/answer switch on rear panel... NO POWER SUPPLY REQUIRED.

ASCII KEYBOARD ASCII-3... 56 KEY/128 CHARACTER ASCII ENCODED... UPPER & LOWER CASE... FULLY DEVELOPED... 2 KEY ROLL-OVER... POS OR NEG LOGIC WITH POS STROBE... REQUIRES +5 & +12V DC (SUPPLIED FROM VIDEO BOARDS)... PRINTER COMET I... SERIAL I/O TO 9600 BAUD... 80 CHARACTER COLUMN (132 COMPRESSED)... 10" TRACTOR FEED... UPPER/LOWER CASE... INDUSTRY STANDARD RIBBONS... 4 CHARACTER SETS... 9 BY 7 DOT MATRIX... BI-DIRECTIONAL PRINTING



Continental U.S.A. Credit Card Buyers Outside Connecticut
CALL TOLL FREE 800-243-7428

To Order From Connecticut Or For Tech. Assist. Call (203) 354-9375

NETRONICS R&D LTD. Dept.
333 Litchfield Road, New Milford, CT 06776

Please send the items checked below:

COMPLETE FASTERM-64 TERMINAL (includes FASTVID-64 video board ASCII-3 keyboard, steel cabinet and power supply)... kit \$199.95 plus \$3 P&I... wired & tested \$249.95 plus \$3 P&I... graphics option add \$19.95 to each of above

COMPLETE SMARTERM-80 TERMINAL (includes SMARTVID-80 video board, ASCII-3 keyboard, steel cabinet and power supply)... kit \$299.95 plus \$3 P&I... wired and tested \$369.95 plus \$3 P&I

FASTVID-64 VIDEO BOARD (requires +5 & -12V DC)... kit \$99.95 plus \$3 P&I... graphics option add \$19.95... wired & tested \$129.95 plus \$3 P&I... graphics option add \$19.95

SMARTVID-80 VIDEO BOARD (requires +5 & +/-12V DC)... kit \$199.95 plus \$3 P&I... wired & tested \$249.95 plus \$3 P&I

DELUXE STEEL TERMINAL CABINET... \$19.95 plus \$3 P&I

ASCII-3 KEYBOARD (requires +5 & -12VDC)... kit \$69.95 plus \$3 P&I... wired and tested \$89.95 plus \$3 P&I

POWER SUPPLY (powers ASCII-3 keyboard & video boards)... kit only \$19.95 plus \$2 P&I

ZENITH VIDEO MONITOR (high resolution green phosphor)... wired & tested \$149.95 plus \$6 P&I

TELEPHONE MODEM MODEL 103 O/A... wired & tested \$189.95 plus \$3 P&I

DOT MATRIX PRINTER Comet I... wired & tested \$299.95 plus \$10 P&I

RF MODULATOR MOD RF-1... kit only \$8.95 plus \$1 P&I

3FT-25 LEAD MODEM/TERMINAL OR PRINTER/TERMINAL CONNECTOR CABLE... \$14.95 ea plus \$2 P&I

For Canadian orders, double the postage. Conn. res. add sales tax.

Total Enclosed \$
 Personal Check Cashier's Check/Money Order

VISA MasterCard (Bank No. _____)

Acct. No. _____ Exp. Date _____

Signature _____

Print Name _____

Address _____

City _____ State _____ Zip _____

NETRONICS Research & Development Ltd.
333 Litchfield Road, New Milford, CT 06776

users as offering superior speed and more reliable performance than other correspondence-quality printers.

Another type of printer has a ball-type print element, like that used by the IBM *Selectric*. They are slower than most other impact printers (about 15 characters-per-second), but normally range from \$1500 to \$2000 in price. For do-it-yourselfers who want to invest their time in some weekend labor, rather than spending a large amount of cash, a computer interface for the IBM *Selectric* is available from Escon Products (Pleasant Hill, CA). That kit enables you to modify your existing typewriter so that it will print output from your computer. It will

work with most computers. Prices range from \$500 to \$800—plus labor cost, if you can't do the work yourself.

Among the pluses for the impact printers are the fact that they produce solid characters (as opposed to dot patterns) and, because the print elements can be removed and replaced with others, they allow you to use a variety of type styles.

Interfacing

One important point to keep in mind when you purchase your printer is the interface between it and your computer. The appropriate cables and software are required to achieve effective communication between the two. There are two types

of interfaces: *parallel* and *serial*. Parallel interfaces generally allow greater speed, but require that the printer be very close to the computer. Serial interfaces need simpler cables, and allow the printer to be separated from the computer by 50 feet or more.

Parallel interfaces are commonly used with dot-matrix printers. Bear in mind that not all parallel interfaces are the same and, as you shop for a printer, be sure to inquire whether a specific unit will work with your (specific) computer. That can avoid an enormous amount of frustration, and wasted time and effort, on your part.

Serial interfaces are more standardized than parallel ones, and allow a variety of printers to be used with a variety of computers. The common RS-232C serial-communications standard is used not only for printers, but also for telephone and Teletype communications.

If your computer is equipped for communications capability, it almost certainly has a serial interface. In some cases, additional software may be required to take advantage of all the capabilities of your printer. Make sure that it's available for your computer.

As is the case for all computer purchases, an important criterion is after-sale support and service. Consult with other users to be certain that you are making your purchase from a reputable manufacturer or vendor.

More than any other computer peripheral, a printer will require maintenance after a certain period of usage, due to its mechanical complexity. You'll want to be sure that you will be able to get prompt and reliable service and repair when it is necessary—and know that it won't cost an arm and a leg. If lost time is going to hurt you, see whether a service contract is available.

There are many decisions to make in finding the printer with the features and cost-effectiveness that are best for your applications. Sample a number of different offerings before narrowing your choices down, and try to talk to others who are using the printers you are considering. The time you spend in making your choice will be well worth it in the end.

R-E

Radio-Electronics

SPECIAL REPRINT
BUILD THIS ROBOT FOR UNDER \$400



BUILD THIS ROBOT FOR UNDER \$400

AVAILABLE—COMPLETE for the FIRST TIME!

BUILD YOUR OWN ROBOT!

Send today for your 52-page (8½ × 11") booklet containing complete reprints of all eleven articles in the Build Your Own Robot series by Jim Gupton.

This all-inclusive reprint gives you all the data you need to build your own Robot.

■ TELLS EVERYTHING YOU NEED TO KNOW to build the Unicorn-1 Robot without the need for an engineering degree or special equipment. The robot is fully mobile with manipulator arms to grasp, lift and carry.

■ MANIPULATOR ARMS and end-effectors (hands) are what enable the robot to perform useful tasks. Details of construction techniques and considerations are fully explored.

■ MOBILITY BASE is not a lunar space station. It is the drive system that permits the robot to move from here to there. Full construction details along with a discussion of power sources is included.

■ THE BODY—FRAME AND ROTATION MECHANISM. This is the part that makes Unicorn-1 look like a robot. Wood and Formica are the materials for the body. Motors and gears are what make it function.

■ COMMUNICATIONS. How you can tell your robot what to do. Preprogramming techniques...radio control...computer control are all detailed.

■ SENSORS. How to add sensors so your robot doesn't bump into things.

Radio-Electronics

Robot Reprints
200 Park Ave. South
New York, N.Y. 10003

I want to order _____ reprints @ \$12.00 plus \$1.00 postage and handling for U.S., Canada and Mexico.
Add 99¢ sales tax for New York State residents only.
U.S. Funds only.

I want to order _____ reprints @ \$12.00 plus \$3.00 Air Postage and handling for all other countries.
U.S. Funds only.

Allow 6-8 weeks for delivery.

We do not bill, check must be enclosed.

Please print

383

(Name)

(Street address)

(City)

(State)

(Zip)



"Cloudy again! That makes it twenty-six straight days!"

SATELLITE TELEVISION RECEIVER

KITS



*Rainbow makes
a top-of-the-line
Receiver affordable*

The Electronic Rainbow Receiver consists of a receiver with an external down-converter that mounts at the antenna, feeds the voltage to the LNA through the coax cable. The 4GHz signal is down converted to 70 MHz and is fed through the RG59/U coax to the receiver.

Rainbow Kits are supplied with simple step by step instructions. All the circuits that you need expensive test equipment to do are pre wired and tested. All printed circuit boards have the outline of each part printed on them.

RECEIVER FEATURES

Built in RF modulator • Detent Tuning-3.7 to 4.2 GHz • Variable Audio-5.5 to 7.5 MHz • Invert Video • Channel Scan • Voltage monitoring • Meter output • Remote Tuning

SPECIFICATIONS:

Single Conversion Image Rejection Downconverter • Threshold 8 db CNR • IF Bandwidth 24MHz • Output IV Audio and Video • IF Frequency 70MHz • Video Bandwidth 4.5MHz • Size 3 1/2" H x 8 1/2" D x 11 1/4" W

Complete Satellite TV Receiver

KIT #1 — Contains:

- Mainboard • Tuning Board • Down-converter Board • Modulator Board
- All parts needed to complete receiver
- Down Converter built in case.
- Cabinet, attractive black brushed anodized metal with silk screened front and back for a professional look
- 70 MHZ Filter is pre-wired and tested.
- Complete instruction Manual.

\$395.00

KIT #2 — Board Kit Contains:

- Main Board • Tuning Board • Down-converter board • Modulator Board
- Parts List, assembly and alignment manual
- 4GHz local oscillator and 70MHz filter is pre-wired and tested.

\$129.00

Instruction manual. Contains printed circuit board layouts, parts placement, and alignment instructions.

\$25.00

*Ask about
guaranteed
to play*

We will accept telephone orders for Visa & Mastercard
No C.O.D. Orders

To Order Call 800-428-3500 317-291-7262
Complete Kit Weighs 10 pounds. Please add Sufficient Postage
6254 La Pas Trail
Indianapolis, Indiana 46268

ELECTRONIC RAINBOW

CIRCLE 88 ON FREE INFORMATION CARD

Keep Magazines, Catalogs, Manuals, Journals

NEAT & ORGANIZED
End Clutter In Home, Office, Workshop With
SHELF FILES



Eliminate the mess of loose magazines, catalogs and newspapers. Find what you want when you want it by using these handy shelf or desk top files. Attractive brown front panel. Adhesive ID labels included.

6 POPULAR SIZES AVAILABLE

From digest size to newspaper size! Popular letter and magazine size (9" x 11 1/2", 3 3/4" box width) - 8 for \$13.95. 25 for \$31.95 prepaid. Sturdy, heavy-duty fiberboard will last for years! Charge it! Call or mail coupon today.



Professional Aids Co., Suite 133
1678 S. Wolf Road, Wheeling, IL 60090 • 312/459-6828

Please rush postpaid Fiberboard Desk and Shelf Files as checked below:

| How Many | Qty. | Size | Price | Total Price |
|----------|-------------|---------|-------|-------------|
| 8 | Letter Size | \$13.95 | | |
| 25 | Letter Size | \$31.95 | | |

Illinois Residents add 6% Sales Tax, please. Other sizes from digest to newspaper available.

Charge it to VISA MasterCard TOTAL:

Card No. _____ Exp. Date _____

Name _____

Address _____

City, State, Zip _____

Check for Free Catalog. I enclose \$_____ full payment. Ship postpaid.

YOUR OWN Personal Switcher

save 20%

POWER SUPPLY

For Lab or Original Equipment

FEATURES: Efficient 30kHz switching frequency • Four Models satisfy most applications • Years of trouble-free service • Each side AC line fuse protected • Tele-Tale LED "Pwr-On" Panel Indicator • Three separate voltage outputs • Metal enclosure provides physical and EMI protection • For experimental use or permanent power source • Soft start feature protects critical circuits • Parallel operation acceptable for higher current needs • Push-in terminals, accept wire or test lead • Light-weight, easy to use • AC line cord permanently attached • Most reliable power source for a variety of uses and applications • 48 hour burn-in assures MTBF of 3 1/2 years, reasonably priced at \$1.90/watt • Full one year guarantee • 2-tone anodized case • Custom volt/current outputs on special order • Input surge protection • Automatic short circuit protection • restoration • UL recognized components • Handy Service Aid

SPECIFICATIONS: Input: 90-132VAC, 47-440Hz • Dual AC Input Fuses • Line Regulation: ±0.1% Max. for 10% input change • Load Regulation: ±0.2% Max. on #1 Output • Ripple Noise: Typ. 1% PP Max. • Over Voltage Protection • Reverse Polarity Protection • Compact, only 7 1/2" x 4" x 2 1/4" • Fast load transient response • 5 volt adj. ±10% • DC Output: 42 Watts continuous • 70% Efficiency

SCHOOLS - LABS - QUANTITY PRICING ON REQUEST

Lcom inc 1545 Osgood St. Unit 11K, No. Andover, MA 01845

Name (Please print) _____
Address _____
City _____ State _____ Zip _____

ORDER INFORMATION
Order First Unit—\$99.50
Second Unit—\$79.60

| Qty. | Model | Output #1 | Output #2 | Output #3 | Total |
|------|-------|-----------|-----------|-----------|-------|
| | PS-1 | 5V-6A | +12V-0.5A | -12V-0.5A | |
| | PS-2 | 5V-6A | +15V-0.4A | -15V-0.4A | |
| | PS-3 | 5V-6A | +12V-0.5A | -5V-1A | |
| | PS-4 | 5V-3A | +24V-0.6A | -24V-0.6A | |

OFFER EXPIRES March 31, 1983
Sub. Total _____
Mass. res add 5% Tax _____
Shipping & Handling 3.50
TOTAL _____

Charge to MasterCard Visa American Express Check/Money Order

Card # _____ Exp. Date _____

Signature _____

PHONE ORDERS: CALL (617)682-6936 FOR PROMPT SERVICE

CIRCLE 75 ON FREE INFORMATION CARD

CIRCLE 23 ON FREE INFORMATION CARD

MARCH 1983

COMMUNICATIONS CORNER

Computerized communications

HERB FRIEDMAN, COMMUNICATIONS EDITOR

NO MATTER HOW MUCH OR HOW FAST I read, it becomes more and more difficult to keep up with computerized communications. Just as I am learning about the latest developments, others come into use that open up new horizons for day-to-day communications. The adventures of one young fellow I know illustrates just how deeply we (meaning the government) have come to depend on computerized communications.

This fellow and some friends went down to Virginia for some scuba diving at Virginia Beach. As you might expect to happen to a car full of laughing teenagers, they were pulled over by a police cruiser. No hassling or anything, just a "routine check." My young friend reached into his wallet for his driver's license and registration and they weren't there. Somehow, he left them back in New York.

Instantly, he has visions of making big rocks into small ones. The cop asks a few questions, such as name, address, insurer, owner of car, previous traffic violations and so forth. He goes to his cruiser, and in a few minutes is back with my friend's life story: name; address, car identification, violations, etc. Everything was transmitted down the New York Motor Vehicular Bureau computer to the Virginia police cruiser. Since everything that my friend said checked out, he was waved off with a warning to keep his license and registration with him in the future.

Now just consider for a moment that it wasn't some well-intentioned teenager out for a weekend of exploring the sea, but rather someone who had robbed a bank, or beat up on some old lady. Today, a call on the radio will bring forth in a matter of minutes the life history of both the driver and the car in question. That's a lot better than having to rely on luck.

A lot of folks will think this is nothing more than another example of how Big Brother is watching. I don't want to get

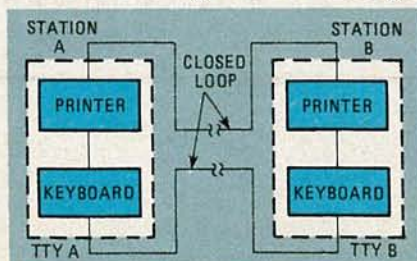

FIG. 1

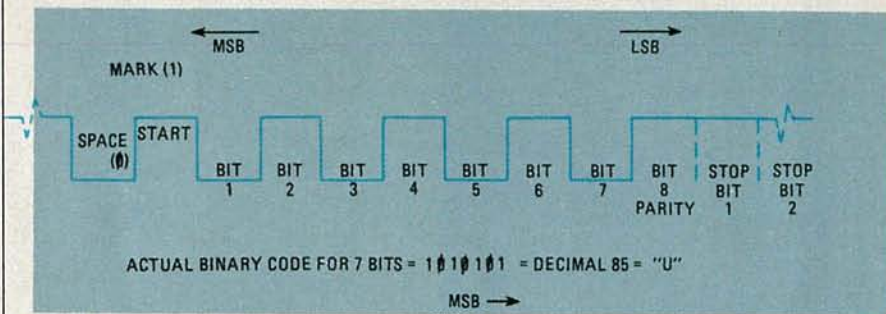

FIG. 2

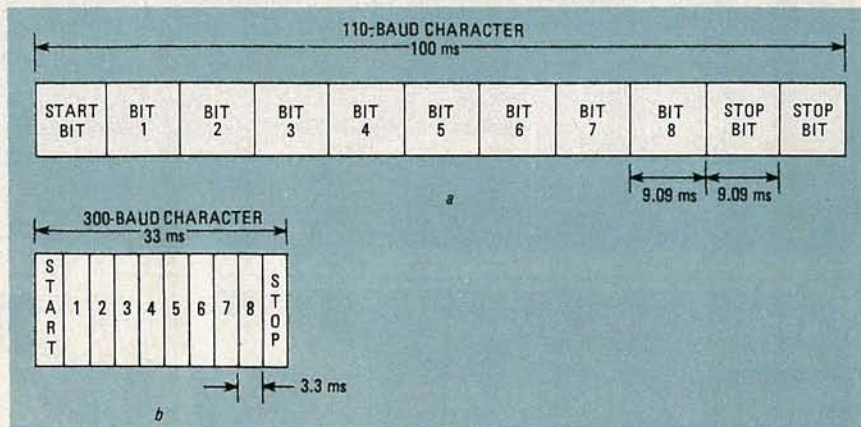

FIG. 3

involved in that discussion. All I'm trying to illustrate is one way in which the computer has dramatically altered one aspect of police radio communications.

The magic of ASCII

As a general rule, computerized communications—data and control—signals are transmitted using ASCII code (ASCII is an acronym derived from the American Standard for Communications Information Interchange). It provides for 128 characters that represent the alphabet, numerals, punctuation, special symbols, and 32 control codes. Control codes provide, among other things, the printer's carriage return and linefeed, signals that turn peripherals on and off, and can cause characters not to be printed.

The ASCII code accommodates the original teletypewriter design, which was entirely mechanical, and was in fact originally intended for use as computer input/output using a terminal such as the model 33 teletypewriter, a mechanical workhorse still being used for computer I/O—though it's fast being phased out because it is slow.

Early teletype circuits used the serial communications loop shown in Fig. 1. The keyboard at each end of the loop is in series with its associated printer, which is also in series with the equipment at the other end. What was typed on a keyboard appeared at its associated printer as well as at the receiving end. Each time a key was pressed, a mechanically-produced series of pulses (a pulse train) was transmitted through the loop. The pulse train consisted of a start pulse to let the printers know a character was to follow, then the pulses that represented the character itself, and finally a pulse(s) to let the printer know the character was complete, cause the character to print, and force a reset of the printer so that it was available for the next character.

In the normal series-TTY connection, current flows through the communications loop during the standby condition and is called the *mark*, representing a "1" or a "high." The pulses are caused by interrupting the current flow; they are called the *spaces*, representing a "0" or a "low."

The ASCII code presently used (it is

almost universal for communications, with the exception of the IBM EBCDIC code, which is less and less frequently used) provides for a total of 10 or 11 bits of information. Those bits include a start bit, seven bits which represent the character, one bit for *parity* (which is a check that can be used to test the reliability of the transmission), and one or two stop bits. A complete 11-bit character representing the letter "U" (decimal code 85) is shown in Fig. 2. For common mechanical teletypewriters, the information is transmitted at 110 bps (bits-per-second), which incidentally works out to a 110-baud rate. Two stop bits are used because 110 baud is intended for mechanical TTY devices that aren't all that precise; the two stop bits insure that the mechanical printer does indeed reset for the next character. Note that the stop bit(s) is a mark, so essentially a mark at least two bits in length signals a reset. The stop bits ensure a minimum mark two-bits in length. The total transmission length for a character at 110 baud is 100 milliseconds, so each bit is 9.09 milliseconds. Maximum data rate is 10 characters-per-second, while is about 100 real-words per minute.

At 300 baud and higher, (the rate used by electronic-controlled TTY's and printers) only one stop bit is necessary because we are dealing with electronic precision; we don't have to allow for mechanical tolerances. A typical 300-baud ASCII character is shown in Fig. 3. Note the total transmission length is 33 ms, with each bit requiring 3.3 ms. This works out to a maximum data rate of 30 characters-per-second, or 300 real-words per minute. A comparison between 110 and 300 baud ASCII characters is shown in Fig. 3.

For computers and computer-associated communications equipment, the ASCII code is handled by what is called an RS-232 interface, a device that translates the ASCII characters to a particular voltage standard. We will cover the RS-232 interface in more detail in a future column. **R-E**

DRAWING BOARD

continued from page 84

things, it's clear our circuit is far from being complete. What we need is an output bus as well as the input bus used by the keyboard encoder. Another shortcoming is that we don't have any easy way to clear an entry other than entering zeros. We can enter numbers from a keyboard and have them show up in a display and even though we can expand to ten digits, more circuitry is needed before the encoder can be put to any practical use.

Next month we'll add all the bells and whistles to our encoder. We'll add a Tri-state data bus, an audio indication of keyboard entry, and the ability to clear the display from the keyboard. **R-E**

TWO COMPACT DVM's

continued from page 64

bend at the final 1/16-inch of one end. With the display supported in a small bench vise, I dropped each wire into the appropriate hole in the display board, where it hung suspended while I soldered it into place. I only installed wires where they were required. When all the wires were in, I straightened them sufficiently to work them into the holes in the construction board. I soldered just one wire at first, to simplify adjusting the height of the display over the board, and then did the rest.

Testing and calibration

You should assemble the two 741 circuits, and then calibrate them before continuing. Connect a known DC-voltage to the +V_{IN} input and measure the output of IC1 at pin 6. It should be exactly one-third of the input. Trim either R1 or R2 if it is not. Then, connect a negative voltage to the other input and adjust R7 so you read one-third that value at IC2's output.

You should set R19 to about 3500 ohms before wiring it into the circuit; if you do that the display will show very nearly the correct voltage when you first turn the system on. After that, it's a simple matter to trim R19 for the final calibration. **R-E**

VIC20 PERSONAL COMPUTER

TOP 10 ARCADE GAMES

VIC-20 TAPE PROGRAM SALE!!

| Rank | Name | List | Sale |
|------|--|---------|---------|
| 1. | Super Paratrooper (Fantastic) | \$24.95 | \$19.95 |
| 2. | Exterminator-Plus (Better than Centipede) | \$24.95 | \$19.95 |
| 3. | Cricket (Better than Frogger) | \$24.95 | \$19.95 |
| 4. | Snackman (Better than Pacman) | \$19.95 | \$15.95 |
| 5. | Galactic Crossfire (you in the middle) | \$19.95 | \$16.95 |
| 6. | Anti Matter Splatter (Nuclear Disaster) | \$24.95 | \$19.95 |
| 7. | Bug Blast (Creepy) | \$19.95 | \$16.95 |
| 8. | Bombs Away (Great) | \$18.95 | \$15.95 |
| 9. | 3-D Maze-Escape | \$16.95 | \$14.95 |
| 10. | Krazy Kong | \$16.95 | \$14.95 |

BUY ANY FOUR — DEDUCT 10% MORE

VIC-20 PROGRAMMING AIDS!!

| | Sale |
|--|---------|
| ● Introduction to basic programming (manual and tapes) | \$22.95 |
| ● Advanced basic programming (manual and tapes) | 22.95 |
| ● Programmers reference manual (288 pages — you must have this!) | 15.95 |
| ● Programmers easy reference card (tables-lists-drawings) | 3.95 |
| ● VIC-20 Revealed (267 pages of VIC secrets) | 11.95 |
| ● 6502 Machine Language Assembler | 24.95 |
| ● 16K Programming cartridge (gives 400% more programming power — get \$24.95 16K adventure game free!) | 89.00 |

- 10 DAY FREE TRIAL • WE HAVE THE LOWEST PRICES
- ONE DAY DELIVERY EXPRESS MAIL • FREE CATALOGS
- WE LOVE OUR CUSTOMERS!

PROTECTO ENTERPRISES (FACTORY-DIRECT)

BOX 550, BARRINGTON, ILLINOIS 60010
Phone 312/382-5244 to order

CIRCLE 90 ON FREE INFORMATION CARD

MARCH 1983

IC TESTER

continued from page 55

ly to having their outputs tied to ground or 5 volts. Also, if a multi-section IC is being checked out, only the section(s) you will be using in the circuit it's intended for need be tested.

Of course, if inserting an IC causes the OVERLOAD LED to light brilliantly, the device may be shorted. Check a good part to be sure before discarding the questionable one. Checking counters or long shift registers can be tedious, so the pulse source may be replaced by the Programmata I pulse generator (see the October 1980 issue of **Radio-Electronics**). Make up a cable with a miniature phone plug on one end to go between the pulse generator and the IC tester. Instead of using the tester's internal pulse-generator, insert that plug into the LO input for the IC's CLOCK pin, and use the Programmata I to clock the IC rapidly. You can then watch the outputs of the last stages change state on the LED's. That's great for devices like the 4020 binary divider.

Adding external circuits

So far, we have concentrated on checking fairly simple IC's. But others—like one-shots and timers, which require additional circuitry to function—can also be checked. The trick is to obtain additional phone plugs, and connect the external circuitry to them. Then plug in that network whenever an IC requiring it is being tested.

For example, suppose you want to check a one-shot. Most one-shots require an external resistor-capacitor network to set the length of the output pulse. A five-second pulse is a good place to start; you can determine the values needed from the IC's data sheet. Solder the parts to the center terminals of two phone plugs (and possibly the outside terminal in the case of the resistor), and insert the plugs into the jacks corresponding to the appropriate IC pins. Trigger the one-shot using the internal pulse-generator; the outputs should immediately change state, and stay the way for about five seconds. If they don't, the part is bad.

There's one type of IC that can cause problems, and that's the device with open-collector outputs. Examples include the 7401 NAND gate. The outputs of those devices won't go high unless an external pull-up resistor is used. The solution is to solder a 1000-ohm resistor across the terminals of a phone plug, and insert it in the HI jack corresponding to the output pin of the section of the IC you're testing (Note that the open-collector outputs are indicated on the data sheet for the part).

You're sure to find other uses for your IC tester; try it as a logic analyzer. **R-E**

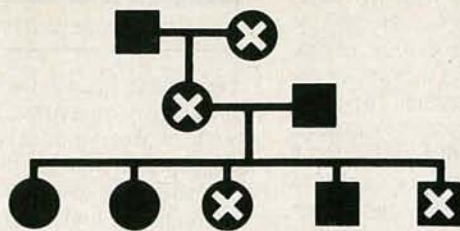

Huntington's Disease Kills on and on and on and on

H NATIONAL HUNTINGTON'S DISEASE ASSOCIATION
Suite 501, 1441 Broadway, New York, N.Y. 10018
212-966-4320

79-8



A PRACTICAL DIGITAL ELECTRONICS KIT FOR LESS THAN \$40 ! Suitable for Beginners

ALSO AVAILABLE

Learn the wonders of digital electronics and see how quickly you are designing your own circuits. The kit contains:

Seven LS TTL integrated circuits, breadboard, LED's, and all the DIL switches, resistors, capacitors and other components to build interesting digital circuits; plus a very clear and thoroughly tested instruction manual (also available separately). All this comes in a pocket size plastic wallet for only **\$39.95**. This course is for true beginners:

- Needs no soldering iron.
- Asks plenty of questions, but never leaves you stuck for an answer.
- Teaches you about fault-finding improvisation and sub-system checking.
- The only extra you need is a 4.5 volt battery or a stabilized 5 volt supply.

Using the same breadboard you may construct literally millions of different circuits.

This course teaches Boolean logic, gating, R-S and J-K flipflops, shift registers, ripple counters and half adders.

Look out for our supplementary kits which will demonstrate advanced arithmetic circuits, opto-electronics, 7-segment displays etc.

NO RISK GUARANTEE

There's absolutely no risk to you. If you're not completely satisfied with your Courses, simply return them in good condition to CLI within 30 days. We'll send you a full refund.

AIR MAIL

The prices shown include surface mail postage anywhere in the World. For Air-Mail shipment please write for additional cost, specifying Courses you will order.

CAMBRIDGE LEARNING Inc.

1 Judith Drive
North Reading,
MA 01864

(617) 664-3657

- Order free by phone
- Mastercard / VISA
- No shipping charges.
- Money-back guarantee
- Tax deductible

Order one of our written Courses to complement your SUPERKIT.

BRAND NEW

DIGITAL COMPUTER DESIGN - a totally revised and updated Course using the programmed learning system. This Book is not intended for beginners but is ideally suited to scientists, engineers and hobbyists who want to know more about digital electronics. **\$17.95**

Digital Computer Logic & Electronics - an introduction to digital electronics designed specifically for the raw beginner. No mathematical knowledge is assumed other than simple arithmetic and no electronic knowledge is expected at all. If you're just starting with Digital Electronics, this is the Course for you **\$13.95**

PHONE ORDERS - FREE

To order by phone, call (617) 664-3657 with your credit card information. It won't cost you a dime, because we'll deduct the cost of the call from the price of the Courses you order.

TO ORDER BY MAIL

You may use the order form below if you wish, but you don't need to. Just send your check or money order (payable to Cambridge Learning Inc.) to the address below. Make sure you enclose your address and specify which Courses you are ordering. Payment must be in US Dollars drawn on major US Bank.

Mass. Residents add 5% sales tax. We pay all surface shipping costs.

Company Purchase Orders also accepted.

TO: Cambridge Learning Inc., 1 Judith Drive, North Reading MA 01864

Please send me

_____ SUPERKITS \$39.95 \$ _____
_____ sets of Digital Computer Design \$17.95 \$ _____
_____ sets of Digital Computer Logic & Electronics \$13.95 \$ _____

Enclosed is check/money order for total \$ _____
(payable to Cambridge Learning Inc.) Mass. Residents add 5% Sales Tax

NAME
ADDRESS
CITY / STATE / ZIP

CIRCLE 19 ON FREE INFORMATION CARD

The world of electronics gee-wizardry

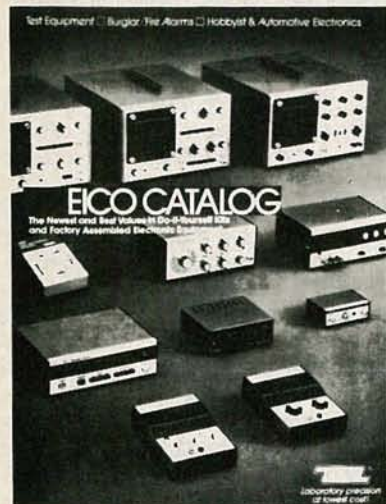

-YOURS FREE.

32-pages of test instruments—from the latest digital multimeters to the famous EICO scopes. Security systems. Automotive and hobbyist products. Kits and assembled. EICO quality. EICO value. For FREE catalog, check reader service card or send 50¢ for first class mail.

EICO® 108 New South Road
Hicksville, N.Y. 11801

CIRCLE 28 ON FREE INFORMATION CARD

Put Professional Knowledge and a COLLEGE DEGREE in your Electronics Career through HOME STUDY



Earn Your DEGREE

No commuting to class. Study at your own pace, while continuing your present job. Learn from easy-to-understand lessons, with help from your home-study instructors whenever you need it.

In the Grantham electronics program, you first earn your A.S.E.T. degree, and then your B.S.E.T. These degrees are accredited by the Accrediting Commission of the National Home Study Council.

Our free bulletin gives full details of the home-study program, the degrees awarded, and the requirements for each degree. Write for *Bulletin R-83*.

Grantham College of Engineering
2500 So. LaCienega Blvd.
Los Angeles, California 90034

Remove Vocals

Remove the lead vocal and substitute your own voice with most stereo recordings using our new, low cost VOCAL ZAPPER™. Great for practice, professional demos or just for fun.

WITH THE
VOCAL ZAPPER™



CHARGE TO VISA OR MC TOLL-FREE
1-800-654-8657 9AM to 5PM CST MON-FRI

DIRECT INQUIRIES TO:

PAIA Electronics, Inc.

1020 W. Wilshire, Oklahoma City, OK 73116 (405)843-9626

- Rush my Vocal Zapper Kit, \$24.95 plus \$3 postage & handling enclosed.
 Send assembled Vocal Zapper, \$39.95 plus \$3 postage enclosed. Send Free Catalog

name _____
address _____
city _____ state _____ zip _____
PAIA Electronics, dept. 3R 1020 W. Wilshire, Okla. City, OK 73116

CIRCLE 26 ON FREE INFORMATION CARD

Radio-Electronics REPRINT BOOKSTORE

- | | |
|--|--|
| <input type="checkbox"/> Build Your Own Satellite TV Receiver..... \$7.00 | <input type="checkbox"/> Radio-Electronics back issues (1981)..... \$3.50 |
| <input type="checkbox"/> 8-Ball Satellite TV Antenna..... \$5.00 | (March, December 1981 not available) |
| <input type="checkbox"/> Build Your Own Robot..... \$12.00 | Write in issues desired _____ |
| <input type="checkbox"/> TV Descrambler (January, February 1981)..... \$3.00 | <input type="checkbox"/> Radio-Electronics back issues (1978-79)..... \$4.00 |
| <input type="checkbox"/> Video Entertainment (January 1982)..... \$2.00 | (October, November 1978 not available) |
| <input type="checkbox"/> Your Own Computer (October 1981)..... \$3.00 | Write in issues desired _____ |
| <input type="checkbox"/> Radio-Electronics back issues (1982)..... \$3.00 | <input type="checkbox"/> Special Projects (Winter 1980)..... \$4.00 |
| Write in issues desired _____ | <input type="checkbox"/> Special Projects (Spring 1981)..... \$4.00 |
| <input type="checkbox"/> Radio-Electronics back issues (1980)..... \$4.00 | <input type="checkbox"/> Special Projects #4 (Summer 1982)..... \$4.00 |
| (March, May 1980 not available) | <input type="checkbox"/> Special Projects #5 (Winter 1983)..... \$3.00 |
| Write in issues desired _____ | <input type="checkbox"/> Radio-Electronics Annual 1983..... \$2.50 |
| <input type="checkbox"/> Radio-Electronics back issues (1980)..... \$4.00 | <input type="checkbox"/> How to Make PC Boards..... \$2.00 |
| (March, May 1980 not available) | <input type="checkbox"/> All About Kits..... \$2.00 |
| Write in issues desired _____ | |

To order any of the items indicated above, check off the ones you want. Complete the order form below. Include your payment, check or money order (DO NOT SEND CASH), and mail to Radio-Electronics, Reprint Department, 200 Park Ave. South, New York, NY 10003. Please allow 4-6 weeks for delivery.

If you need a copy of an article that is in an issue we indicate is unavailable you can order it directly from us. We charge 50¢ per page. Indicate the issue (month & year), pages and article desired. Include payment in full, plus shipping and handling charge.

ARTICLE _____
MONTH _____ YEAR _____
PAGES _____
TOTAL PAGES _____ @ 50¢ each TOTAL PRICE _____

MAIL TO: **Radio-Electronics** 3/83
Reprint Department, 200 Park Ave. South, New York, NY 10003 All payments must be in U.S. funds

Total price of order \$ _____
Sales Tax (New York State Residents only) \$ _____
Shipping & Handling (U.S. & Canada only) (Includes FIRST CLASS POSTAGE) \$1.00 per item \$ _____
All other (\$2.00 per item, sea mail) \$ _____
(\$4.00 per item, air mail) \$ _____
Total Enclosed \$ _____
Name _____
Address _____
City _____ State _____ Zip _____

YOUR EXCITING NEW HOBBY!

- Enjoy fantastic savings by assembling your own organ or piano.
- It's easy. No technical knowledge required.
- Just follow our clear, pictured instructions.
- Choose from many models from portables to consoles.
- Ask about our interest-free installment plan.

WERSI

ORGAN & PIANO KITS

For Free Information Pack M40

Call Toll Free
800-233-3865
In PA 717-299-4327



or send coupon below

WERSI Dept M40 P.O. Box 5318
Lancaster, PA 17601

- Free Info. Pack: Organ Piano
 Catalog & Demo Record (enclose \$6)

Name _____
Address _____
City _____ State _____ Zip _____
Phone (_____) _____

Rep inquiries invited

CIRCLE 29 ON FREE INFORMATION CARD

MARCH 1983

101

SAVE!

MONEY • TIME • FREIGHT

QUALITY STEREO EQUIPMENT AT LOWEST PRICES.

YOUR REQUEST FOR QUOTATION RETURNED SAME DAY.

FACTORY SEALED CARTONS—GUARANTEED AND INSURED.

SAVE ON NAME BRANDS LIKE:

| | |
|----------|--------|
| PIONEER | JVC |
| KENWOOD | TEAC |
| MARANTZ | SANSUI |
| TECHNICS | SONY |

AND MORE THAN 50 OTHERS BUY THE MODERN WAY BY MAIL—FROM

illinois audio

BANK CARDS ACCEPTED

12 East Delaware

Chicago, Illinois 60611

312-664-0020

800-621-8042

CIRCLE 67 ON FREE INFORMATION CARD

SHORTWAVE RECEIVERS

continued from page 52

you like to listen to, you can line up all the pre-sets and go from one to the next as the evening progresses.

Antennas

All portables are equipped with telescoping whip antennas for shortwave (also used for FM if the radio has that band). While the whips are adequate for strong stations like the BBC, Radio Moscow, Radio Nederland, Radio Australia, and many others, you will be able to hear more stations and overcome more adverse propagation conditions with the help of an external antenna when you're at home. And all portables, including the shirt-pocket radios, have provisions for attaching an external antenna.

Basically, an antenna's function is to intercept as much extremely low power radio energy (signals) as possible. Therefore, antennas that are high, long, and located as far away from trees or buildings will be most effective.

Outdoor wire antennas meet those requirements and are easy to install. Wire length for a receiving antenna is not critical, but the longer it is the better. Several

commercially made antennas have tuned "traps" to help peak the wire's performance on the shortwave frequencies. Even if apartment, condominium, or aesthetic rules won't allow an outdoor antenna, you have the option of running wires in the attic, along exterior-wall baseboards, etc.

There is another type of indoor antenna that doesn't need any long lengths of wire, and can be almost as effective as an outdoor aerial: the active antenna. That type of antenna consists of either a telescoping whip or dipole antenna fed to the receiver through a tunable amplifier. The amplifier boosts the signal intercepted by the shortened antenna. The MFJ-1020 active antenna (from MFJ Enterprises) with its short 21-inch whip far outperforms a receiver's built-in whip. Stations barely audible on the built-in antenna can be heard comfortably with the help of that active antenna. As with many active antenna amplifier sections, there are connectors to use the amplifier with external wire antennas for superb performance if you later add an outdoor wire.

A recent addition to MFJ's line is the MFJ-1024 outdoor active antenna. A 4½ foot telescoping whip and its small RF amplifier can be mounted inconspicuously outdoors, and connected to the control unit located next to the receiver via 50 feet of coaxial cable (which is supplied).

Gilfer Shortwave, a mail-order shortwave specialist, offers two active antennas made by Datong, one each for indoors and outdoors. Both are dipoles (i.e., two short antenna elements emanating from a central preamplifier box) and can be mounted horizontally, which often reduces atmospheric and local electrical noise in the receiver, while also being less conspicuous.

Unlike local radio stations, which are limited in their range, international shortwave programs can join you on your travels, literally anywhere in the world. Often the sound of a familiar commentator or program will help you feel more "at home" even if you're far from home. And the latest generation of portable shortwave receivers let you take it all with you. R-E

A 10 HOUR TAPE RECORDER

Modified Panasonic Slimline high quality AC-DC Recorder provides 5 continuous hrs. of recording & play back of top quality sound on each side of cassette for a total of 10 hrs. Built-in features include:

- Digital counter, etc. TDK DC-180 Cassette included.



PHONE RECORDING ADAPTER

Records calls automatically. All Solid state connects to your telephone jack and tape recorder. Starts recording when phone is lifted. Stops when you hang up. **\$24.50*** FCC APPROVED



VOX VOICE ACTIVATED CONTROL SWITCH

Solid state. Self contained. Adjustable sensitivity. Voices or other sounds automatically activate and control recorder. Uses either recorder or remote mike. **\$24.95***



*Add for ship. & hdg. Phone Call Adapter & VOX \$1.50 ea—Recorder \$4.00. Cal. Res. add tax. Mail order. VISA, M/C, cod's ok. Qty. disc. avail. Money back guar. Free data. Dir. inq. inv. **AMC SALES, Dept. A, 9335 Lubec St., Box 928, Downey, CA (213) 90241 Phone 869-8519**

RADIO-ELECTRONICS

CIRCLE 25 ON FREE INFORMATION CARD



DON'T BLAME THE SOFTWARE!

Power Line Spikes and Hash often cause memory loss or erratic operation. Often floppies, printer & processor interact!

OUR patented ISOLATORS eliminate equipment interaction AND curb damaging Power Line Spikes, Surges and Hash.

Filtered 3-prong sockets and integral Spike Suppression. 125 VAC, 15 Amp, 1875 W Total - 1 KW per socket.

- ISO-1 ISOLATOR. 3 Filtered Sockets; 1000 Amp 8/20 usec Spike Suppressor \$76.95
- ISO-4 ISOLATOR. 6 Filtered Sockets; 1000 Amp 8/20 usec Spike Suppressor \$128.95
- ISO-3 SUPER-ISOLATOR. 3 DUAL filtered Sockets; 2000 Amp 8/20 usec Spike Suppressor \$115.95
- ISO-7 SUPER-ISOLATOR. 5 DUAL filtered Sockets; 2000 Amp 8/20 usec Spike Suppressor \$186.95

Master-Charge, Visa, American Express
TOLL FREE ORDER DESK 1-800-225-4876
(except AK, HI, MA, PR & Canada)

Electronic Specialists, Inc.

171 South Main Street, Natick, MA 01760

Technical & Non-800: 1-617-655-1532

CIRCLE 24 ON FREE INFORMATION CARD



"He should have known better than to tangle with a solid-state computer."

EQUIPMENT REPORTS

continued from page 39

tion remains in a slow setting, which is good for listening to sideband transmission, but which doesn't promote top CW reception. It needs a switchable fast/slow AGC action. However, that really would be noticed more by the CW fanatic, rather than the casual listener.

The *R-1000* is one of the few rigs on the market with as much as 60 dB of signal attenuation. It is switchable in 20-dB steps. In the 60-dB position, the built-in attenuator virtually eliminates front-end overload.

While there is no provision for 12 VDC mobile operation, the *R-1000* still comes equipped with a noise blanker to take care of pulse-type noise. It does eliminate ignition noise from nearby cars, which can be a problem if you live near a major road.

No modern receiver would be complete without a few other bells and whistles and this one is no exception. It features an easily-settable digital clock which is accurate to about 15 seconds per month. There is also a timer which can serve as a wake-up alarm or can serve to fire up the radio for taping various broadcasts while you are away from home.

The *R-1000* also features more than enough audio output potential with a minimum of 1.5 watts available at 10 percent distortion. The built-in speaker provides excellent fidelity; however, there is also a jack for an external 8-ohm speaker. The internal speaker is muted when an external one is used. A head-phone jack is also included.

Power consumption is a nominal 20 watts, making this a cool-running unit.

The *R-1000* is a superheterodyne receiver with a few image problems. It uses a standard frequency-down-conversion to achieve the final 455 kHz intermediate frequency. The down conversion begins with a first IF of 48.055 which is heterodyned with other frequencies to produce the 200 kHz to 30 MHz range of this receiver.

Overall, I was quite pleased with the simplicity of operation and the straightforward but sophisticated design of the *R-1000*. About the only drawbacks are the necessity for the extra medium-wave antenna input and the slow AGC action. A good feature is its ability to operate on a variety of voltages from 100 to 240 VAC. Thus it should be able to be used almost anywhere in the world you care to take it.

The Kenwood *R-1000* would be a worthy addition to anyone's radio shack, whether that person is a shortwave listener or an amateur radio buff. It is available from Trio-Kenwood Communications, Inc. at 1111 West Walnut St., Compton, CA 90220 and its price is \$499. **R-E**

NEW BOOKS

For more details use the free information card inside the back cover

THE MASTER HANDBOOK OF ACOUSTICS, by F. Alton Everest. TAB Books, Inc., Blue Ridge Summit, PA 17214. 352 pp. including appendix, references, and index; 5 × 8½ inches; softcover; \$12.95.

Acoustics, the science of sound, has two natures: physical and psychophysical. Sound as a disturbance in the air is physical; sound as perceived by the ear is psychophysical. The old conundrum, "If a tree falls in the forest with no ear to hear it, is sound produced?", distinguishes between sound as a stimulus and sound as a sensation.

This book deals with both the physical and psychophysical aspects of sound because the two are interrelated so inextricably. Whether the end product is a recording, a radio or television program, or a live performance, the human ear-brain mechanism is involved intimately. In the electronics medium, room acoustics is involved twice: once in the pickup and recording in the studio, and again in reproduction in the home or classroom. Human ears listen and evaluate at both ends of the process.

All the basis of sound are covered: frequency, wavelength, simple sinusoid and complex waves, harmonics, phases, octaves, the sound spectrum, and white and pink noise. There is much detail on hearing—including discussions on ear sensitivity, ear anatomy, audibility, loudness versus frequency, loudness versus intensity, and loudness versus bandwidth. Hearing impulses, binaural localization, pitch versus frequency, timbre versus spectrum, the nonlinearity of the ear, Haas sense, the ear as a measuring instrument, hearing-loss with age, occupational and recreational deafness—all are outlined clearly.

The book is fully illustrated with diagrams, schematics, and actual photos of acoustical test equipment, thus serving as a complete sourcebook and comprehensive manual on acoustics that will appeal to any audio buff.

CIRCLE 121 ON FREE INFORMATION CARD

COMPUTERS AND THE RADIO AMATEUR, by Phil Anderson. Prentice-Hall, Inc., Englewood Cliffs, NJ 07632. 208 pp. including index; 7 × 9½ inches; hardcover; \$18.95.

This book is designed for radio amateurs who have had little or no exposure to computers. It explains in detail how they work, how to program them, and how to attach them to other equipment.

Chapters one and two explore present and future uses for computers in amateur radio, and the history and background of the computer. Chapter three explores how computers work. An analogy is made to how people solve mathematical problems, the point being that once a procedure for solving a problem is programmed, the computer will then follow, step by step, as laid out. The building blocks

of the computer are examined and the reader is shown how they work together to follow a program that has been stored in memory.

Chapters four and five deal with programming procedures, first the fundamentals of BASIC, then assembly-language programming. The 6502 microprocessor is used as an example, and several straightforward programs are presented. Further chapters deal with logic circuits, interfacing amateur equipment, the computer as an electronic keyer, the computer as a random-code generator, the computer as a code reader, the computer as a contest secretary, and the computer as a programmable calculator.

CIRCLE 122 ON FREE INFORMATION CARD

PRACTICAL BASIC PROGRAMS: IBM PERSONAL COMPUTER EDITION, edited by Lon Poole; Osborne/McGraw-Hill, 630 Bancroft Way, Berkeley, CA 94710; 170 pages; 8¾ × 10¾ inches; softcover; \$15.99.

Considering all the small computers people have bought in recent years, one would think that it is easy to find practical computer programs, particularly since fewer users consider their computers as just a diversion. However, practical programs are *not* readily available, and most packages on the market today are specialized and expensive. In this book users will find 40 useful programs that cost less than 50¢ each; they are fully documented and each program has been tested and debugged, and is ready to run.

The programs run from income averaging to musical transposition, and include present value of a tax deduction, checkbook reconciliation, home budgeting, transportation algorithm, data-forecasting divergence, temperature conversion, and numeric base conversion. Each program is presented with a description, sample run, practical problems, and BASIC source listings. Using the documentation, anyone can run a program and easily make modifications to it.

CIRCLE 123 ON FREE INFORMATION CARD

SHORTWAVE FREQUENCY DIRECTORY, 1.6 - 30 MHz, Worldwide Edition, edited by Robert B. Grove; Grove Enterprises, Inc., Brasstown, NC 28902; 218pp., 8½ × 11 inches, spiral bound; \$12.95 plus \$1.50 UPS or \$1.00 bookrate USPS.

There are thousands of worldwide listings in this book, many never published before. The listings include US Air Force, US Navy, US Coast Guard, US Army, foreign military, Department of Energy, Federal Emergency Management Administration, US State Department and Embassies, Federal Communications Commission, Department of Interior, spy numbers schedules, drug-smuggling networks, mysterious beacons, pirate and clandestine broadcasters, and innumerable others. **R-E**

CIRCLE 124 ON FREE INFORMATION CARD

Electronics Paperback Books

Quality Paperbacks at Affordable Prices

BUY 12 PAY FOR 10—TAKE 2 FREE!



- 30 SOLDERLESS BREADBOARD PROJECTS BOOK-1.** \$5.75. Whenever possible, the same parts are used in several projects. Even a first-time builder can complete these circuits.
- HOW TO GET YOUR ELECTRONIC PROJECTS WORKING.** \$5.00. Helps you troubleshoot and repair home-built projects of every description.
- MINI-MATRIX BOARD PROJECTS.** \$5.00. A variety of projects that can all be built upon a mini-matrix board that has 10 strips and is 24 holes long.
- MODERN OP-AMP PROJECTS.** \$5.00. Wide range of specialized op-amp circuits including hi-noise, hi-distortion, ultra-hi input impedance, etc.
- MULTI-CIRCUIT BOARD PROJECTS.** \$5.00. 21 fairly simple projects that can all be built on a single printed-circuit board. All are powered by a 9V battery.
- IC PROJECTS FOR BEGINNERS.** \$5.00. Inexpensive digital and linear IC's are used to assemble this selection of circuits intended for the beginner.



- ART OF PROGRAMMING THE 1K ZX81.** \$6.25. Topics include full screen, scrolling, PEEK & POKE, plus actual working programs.
- THE 6809 COMPANION.** \$5.00. Written for the average assembly language programmer. A discussion of 6809 features & reference work for the 6809 programmer.
- PRACTICAL COMPUTER EXPERIMENTS.** \$4.50. Fills in background to microprocessor by constructing typical computer circuits using discrete logic components.
- ART OF PROGRAMMING THE 1K ZX81.** \$5.00. How to use the features of the ZX81 in programs that fit the 1K machine and are still fun to use.
- INTRODUCTION TO BASIC PROGRAMMING TECHNIQUES.** \$5.00. Based on author's own experience in learning BASIC and helping others to learn to program.
- A MICROPROCESSOR PRIMER.** \$4.50. Painless approach to computing for the beginner. Step-by-step explains computer operations and assembly.

- FIRST BOOK OF HI-FI SPEAKER ENCLOSURES.** \$4.50.
- SOLID STATE NOVELTY CIRCUITS.** \$3.50.
- 28 TESTED TRANSISTOR PROJECTS.** \$4.25.
- SOLID-STATE SHORTWAVE RECEIVERS FOR BEGINNERS.** \$4.50.
- 50 PROJECTS USING IC CA 3130.** \$4.50.
- 50 CMOS IC PROJECTS.** \$4.50.
- HOW TO BUILD ADVANCED SHORTWAVE RECEIVERS.** \$5.00.
- BEGINNERS GUIDE TO BUILDING ELECTRONIC PROJECTS.** \$5.00.
- ESSENTIAL THEORY FOR THE ELECTRONICS HOBBYIST.** \$5.00.
- FIRST BOOK OF TRANSISTOR EQUIVALENTS & SUBSTITUTES.** \$3.75.
- PRACTICAL COMPUTER EXPERIMENTS.** \$4.50.
- ENGINEERS & MACHINISTS REFERENCE TABLES.** \$3.50.
- SECOND BOOK OF TRANSISTOR EQUIVALENTS & SUBSTITUTES.** \$4.50.
- 52 PROJECTS USING IC 741.** \$4.00.
- BEGINNERS GUIDE TO μPROCESSORS & COMPUTING.** \$4.50.
- V MOS PROJECTS.** \$5.00.
- HOW TO USE OP-AMPS.** \$5.75.
- AUDIO PROJECTS.** \$5.00.
- MODEL RAILWAY PROJECTS.** \$5.00.
- CB PROJECTS.** \$5.00.
- HOW TO GET YOUR ELECTRONIC PROJECTS WORKING.** \$5.00.
- MULTI-CIRCUIT BOARD PROJECTS.** \$5.00.
- ELECTRONICS SIMPLIFIED CRYSTAL SET CONSTRUCTION.** \$4.50.
- ELECTRONIC HOUSEHOLD PROJECTS.** \$4.50.



- POWER SUPPLY PROJECTS.** \$4.50. Contains designs and construction details for almost any power supply the experimenter is likely to need.
- REMOTE CONTROL PROJECTS.** \$5.00. Radio-control infra-red, visible light, & ultrasonic systems are all included, along with methods of applying them.
- ELECTRONIC TEST EQUIPMENT CONSTRUCTION.** \$4.50. Construction details of a wide range of test equipment the experimenter can build at home.
- ELECTRONIC PROJECTS USING SOLAR CELLS.** \$5.00. Simple circuits that have numerous applications around the home.
- ELECTRONIC TIMER PROJECTS.** \$5.00. Timing circuits for almost any application the experimenter might need. A most valuable reference.
- COUNTER DRIVER & NUMERICAL DISPLAY PROJECTS.** \$4.50. Features applications & projects using various types of numerical-display devices.



- PRACTICAL ELECTRONICS CALCULATIONS AND FORMULAE.** \$7.50. A basic reference work that bridges the gap between complicated technical theory & cut and tried methods.
- INTERNATIONAL DIODE EQUIVALENTS GUIDE.** \$5.75. Helps you find substitutes for the many different types of semiconductor diodes in use today.
- INTERNATIONAL TRANSISTOR EQUIVALENTS GUIDE.** \$7.50. Products of more than 100 manufacturers are listed & cross-referenced with possible replacements.
- HOW TO MAKE WALKIE TALKIES.** \$5.00. Describes equipment for low-power handheld operation. 112 pages of must reading for the dedicated experimenter.
- ELECTRONIC CALCULATOR USERS HANDBOOK.** \$3.95. Presents formulae data, methods of calculation, conversion factors & more from the view of the calculator user.
- LINEAR IC EQUIVALENTS AND PIN CONNECTIONS.** \$8.25. Shows equivalents & pin connections of a popular user-oriented selection of linear IC's.



- ELECTRONIC SYNTHESIZER PROJECTS.** \$4.50.
- 50 CIRCUITS USING GERMANIUM, SILICON & ZENER DIODES.** \$3.75.
- 50 PROJECTS USING RELAYS, SCR'S & TRIACS.** \$5.00.
- 50 (FET) FIELD-EFFECT TRANSISTOR PROJECTS.** \$4.50.
- 50 SIMPLE LED CIRCUITS.** \$4.25.
- 50 CIRCUITS USING 7400 SERIES IC'S.** \$4.50.
- 50 SIMPLE LED CIRCUITS BOOK 2.** \$3.95.
- PROJECTS USING 555 IC'S.** \$5.00.
- PROJECTS USING LM3900 IC'S.** \$4.75.
- RADIO CONTROL FOR BEGINNERS.** \$4.50.
- ELECTRONIC GAMES.** \$4.50.
- SINGLE IC PROJECTS.** \$4.25.
- RADIO CIRCUITS USING IC'S.** \$4.50.
- ELECTRONIC PROJECTS FOR BEGINNERS.** \$5.00.
- ELECTRONIC MUSIC & CREATIVE TAPE RECORDING.** \$5.00.
- ELECTRONIC SECURITY DEVICES.** \$5.00.
- HOW TO BUILD YOUR OWN SOLID-STATE OSCILLOSCOPE.** \$5.00.
- SECOND BOOK OF CMOS IC PROJECTS.** \$4.25.
- PRACTICAL CONSTRUCTION OF PRE-AMPS, TONE CONTROLS, FILTERS AND ATTENUATORS.** \$3.75.
- BEGINNERS GUIDE TO DIGITAL TECHNIQUES.** \$3.75.
- ELECTRONIC HOUSEHOLD PROJECTS.** \$4.50.
- ELECTRONIC MUSIC PROJECTS.** \$4.50.
- POPULAR ELECTRONIC PROJECTS.** \$3.75.
- PROJECTS IN OPTO-ELECTRONICS.** \$5.00.



- ANTENNA PROJECTS.** \$5.00. Covers practical antenna designs including active, loop & ferrite types that are easy & inexpensive to build.
- RADIO STATIONS GUIDE.** \$4.75. Comprehensive listing of transmitters around the world. Presents location, frequency, power.
- LONG DISTANCE TV RECEPTION (TV-DX) FOR THE ENTHUSIAST.** \$5.00. Practical & authoritative introduction to this unusual aspect of electronics.
- CB PROJECTS.** \$5.00. A number of useful and interesting designs for CB accessories. Speech processor, interference filter & more.
- CRYSTAL SET CONSTRUCTION.** \$4.50. Packed full of easy to duplicate designs for crystal radio receivers.
- AN INTRODUCTION TO RADIO DXING.** \$5.00. Listen, in your home, to broadcasts originating thousands of miles away. Tells how you can do it.

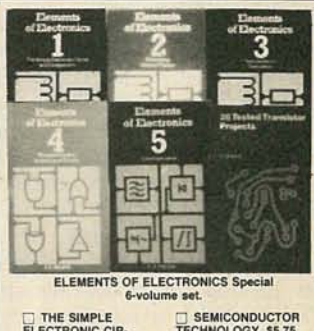

- ELEMENTS OF ELECTRONICS Special 6-volume set.**
- THE SIMPLE ELECTRONIC CIRCUIT & COMPONENTS.** \$5.75. All the fundamental theory needed to lead to a full understanding of the simple electronic circuit and its components.
 - ALTERNATING CURRENT THEORY.** \$5.75. Alternating current theory without which there can be no comprehension of speech, music, radio, or Television.
 - MICROPROCESSING SYSTEM & CIRCUITS.** \$7.50. A truly comprehensive guide to all of the elements of a microprocessing system.
 - SEMICONDUCTOR TECHNOLOGY.** \$5.75. Everything you always needed to know about solid-state devices in one volume.
 - COMMUNICATIONS.** \$7.50. Covers most modern communication systems. Line, microwave, submarine, satellite, digital multiplex, radio & telegraphy.
 - AUDIO.** \$9.00. Chapter after chapter investigates every important aspect of audio circuitry.
 - SPECIAL OFFER—Complete set of all six volumes—a bargain that saves you \$6.25—SPECIAL PRICE \$35.00 FOR THE COMPLETE SET.**

ELECTRONIC TECHNOLOGY TODAY INC.
P.O. Box 83, Massapequa Park, NY 11762

Number of books ordered

Total Price of Books\$.....

Sales Tax (NY State Residents)

Shipping (75c 1st two books, 30c ea additional)

TOTAL ENCLOSED\$.....

Name _____

Address _____

City _____ State _____ ZIP _____

Prices good until April 30, 1983

MARKET CENTER

PLANS & KITS

CABLE TV converters and equipment. Plans and parts. Build or buy. For information send \$2.00. **C & D ELECTRONICS**, PO Box 21, Jenison, MI 49428

TAILGATERS beware! Clever device ends this hassle. Quick, easy installation. Kit \$4.95, two for \$8.95. **TAILGUARD**, 8 Alpine Place, Franklin, MA 02038

DIGITAL UHF STV kit \$250.00. Deluxe sine wave kit \$153.00. Others. STVCO, Box 18039, Orlando, FL 32860

NEW! Repair any TV ... Easy. Anyone can do it. Write **RESEARCH**, Box 517E, Brea, CA 92621

MICROWAVE television "downconverters." Exclusive new five stage design. Easily assembled. Catalogue: \$2.00 (refundable). **NDS**, Box 12652-R, Dallas, TX 75225

FREE KIT Catalog
 FUNCTION GENERATOR KIT \$59.95
 Auto-Ranging Cap-meter kit \$79.95
Phone 415-447-3433
 Write or Phone for FREE CATALOG.
 Average 1 minute Saturday call is 21¢.
DAGE SCIENTIFIC INSTRUMENTS
 BOX 1054R LIVERMORE CA 94550

contains
TEST & EXPERIMENTER'S EQUIP.

SEE THE WEATHER AND SAVE \$1,000!



A leading manufacturer of commercial weather chart recorders has developed a facsimile Weather Chart Recorder Kit for use by hobbyists, amateurs, pilots, and educators.

All you need is a stable HF general-coverage receiver to tune in weather facsimile frequencies—your recorder will print out accurate weather charts. Major components in this easy-to-build kit are pre-assembled and tested. And the recorder is backed by a limited warranty against defects. Special kit price is \$995. Add \$5 for shipping and handling in the U.S. and Canada. (For Massachusetts delivery, add \$49.75 sales tax.) Master Card and Visa accepted. Call or write for more information.

ALDEN ELECTRONICS
 10 Washington Street, Westborough, MA 01581
 (617) 366-8851

SAVE steps, money. Use your telephones as an intercom. Plans \$5.00. **dB Enterprises**, Box 453R, Westwood, NJ 07675

CATALOG—transmitters, linears, MDS downconverters, scramblers, broadcasting, CB, hobby plans & kits. \$1.00. **PANAXIS**, Box 130-F3, Paradise, CA 95969

PROJECTION TV ... Convert your TV to project 7 foot picture. Results equal to \$2,500 projector ... Total cost less than \$20.00 ... Plans & lens \$17.50 ... Illustrated information free ... Credit card orders 24 hours. (215) 736-3979. **MACROCOM GG**, Washington Crossing, PA 18977

CLOCK-calendar kit for Apple II. \$49.95 postpaid. Other kits available. **SASE** for spec sheets. **MICROMATION ENGINEERING**, Box 9375, Fort Wayne, IN 46899

UHF conversion kits, gated, sinewave, addressable, and more. Micro antennas, cable equipment. We are the biggest in the area. Call or write for free information. (301) 882-9362. **SATELLITE ELECTRONICS**, P.O. Box 9534, Baltimore, MD 21237. Catalog \$2.00 refundable

IT'S easy to make your own video game cartridges, average cost is only \$10.00 per game. Complete, detailed plans \$9.95. **RANDOM ACCESS**, Box 41770R, Phoenix, AZ 85080

ELECTRONIC SURVEILLANCE: Incredible manual, "Homebrew Bugging" outlines wiretapping, bugging and many other ingenious, yet simple techniques used by professional operatives—\$15.00. We also have manuals on remote control, covert communications, weaponry, exotic alarm systems, and other related topics. Send \$3.00 for our book listings, Catalog B. **A.T.I.S.**, Box 4068, Dearborn, MI 48126

AMAZING Electronic Devices: VOXs, miniature transmitters, telephone transmitters, telephone wiretap defeats, telephone monitors, telephone recording equipment, and much more! Send \$3.00 for our electronic listings (Catalog E) \$3.00 **A.T.I.S.**, Box 4068, Dearborn, MI 48126

LIGHT display sequencer kits. Send stamp for flyer. **DESIGN SPECIALTY**, P.O. Box 1995, Huntington Beach, CA 92647

MINI-COM colourkit-it converts Franklin Ace Microcomputers to instant colour. No colour interference in documentation. Kit plugs under keyboard. Easy installation. **1013 MERIVALE ROAD**, Ottawa, Ontario K1Z 6A6, \$61.95

SINE wave decoder problems? Manual includes trouble shooting, alignment, antenna hook-up, improvements, theory. \$15.00. **SIGNAL**, Box 2512-R, Culver City, CA 90230

PRINTED Circuit Boards from your sketch or diagram. Free information. **BUDGET CIRCUITS**, 6201 Hilston, Dept. E, Austin, TX 78745

PROFESSIONAL electronic devices plans, kits P.O. circuitry, famous drop-in microphone cartridge debugging equipment, more items available. For information send \$2.00 **MOUNTAIN ELECTRONICS**, R2, Box 186A, Charlotte, TN 37036

SUBSCRIPTION TV KITS

UHF Gated Pulse Kit.....\$39.00
UHF Sinewave Kit.....\$37.00
Special Both Kits.....\$59.00
Informative Catalog.....\$ 2.00

Kits include all parts, manual and an etched & drilled PC board. Send for our "Informative Catalog" and find out what type you need.

J & W ELECTRONICS, INC.
 P. O. BOX 61-B
 CUMBERLAND, RI. 02864

To run your own classified ad, put one word on each of the lines below and send this form along with your check for \$1.90 per word (minimum 15 words) to:
Radio-Electronics, 200 Park Avenue South, N.Y., N.Y. 10003

ORDER FORM

PLEASE INDICATE in which category of classified advertising you wish your ad to appear. For special headings, there is a surcharge of \$15.00.

() Plans/Kits () Business Opportunities () For Sale
 () Education/Instruction () Wanted () Satellite Television

Special Category: \$15.00

PLEASE PRINT EACH WORD SEPARATELY, IN BLOCK LETTERS.)

| | | | | |
|----|----|----|----|----|
| 1 | 2 | 3 | 4 | 5 |
| 6 | 7 | 8 | 9 | 10 |
| 11 | 12 | 13 | 14 | 15 |
| 16 | 17 | 18 | 19 | 20 |
| 21 | 22 | 23 | 24 | 25 |
| 26 | 27 | 28 | 29 | 30 |
| 31 | 32 | 33 | 34 | 35 |

PLEASE INCLUDE FOR OUR FILES YOUR PERMANENT ADDRESS AND PHONE NUMBER.

CLASSIFIED COMMERCIAL RATE for firms or individuals offering commercial products or services). \$1.90 per word prepaid (no charge for zip code)...**MINIMUM 15 WORDS**. 5% discount for 6 issues, 10% for 12 issues within one year, if prepaid.

NON-COMMERCIAL RATE (for individuals who want to buy or sell a personal item) \$1.25 per word prepaid...no minimum.

ONLY FIRST WORD AND NAME set in bold caps. Additional bold face (not available as all caps) at 15¢ per word. All copy subject to publisher's approval. **ADVERTISEMENTS USING P.O. BOX ADDRESS WILL NOT BE ACCEPTED UNTIL ADVERTISER SUPPLIES PUBLISHER WITH PERMANENT ADDRESS AND PHONE NUMBER.** Copy to be in our hands on the 20th of the third month preceding the date of the issue (i.e., August issue closes May 20th). When normal closing date falls on Saturday, Sunday, or a holiday, issue closes on preceding working day.

BUSINESS OPPORTUNITIES

ATARI repair business. Start your own. Send \$5.00 for more information to: **IRATA REPAIRS**, 2562 East Glade, Mesa AZ, 85204

MECHANICALLY inclined individuals desiring ownership of Small Electronics Manufacturing Business—without investment. Write: **BUSINESSES**, 92-R, Brighton 11th, Brooklyn, NY 11235

DEALERS wanted: MATV/CATV, antennas, needles, films, free catalog, 212-897-0509. **D & WR**, 66-19 Booth, Flushing, NY 11374

E-Z learn security alarm systems. Employment-business terrific. Information \$1.00 (Redeemable) P.O. BOX 1456-R, Grand Rapids, MI 49501

START your own business. We send everything you need free! No strings! **AF ASSOCIATES**, 424 East St., So. Hadley, MA 01075

PROJECTION TV ... Make \$\$\$'s assembling projectors ... Easy ... Results comparable to \$2,500 projectors ... Your total cost less than \$17.00 ... **Plans, lens, & dealer's information \$15.50** ... Illustrated information **free** ... **MACROCOMGGX**, Washington Crossing, PA 18977. Credit card orders 24 hours. (215) 736-2880

ASSEMBLE profitable devices at home. We ship parts to be assembled. Exceptional opportunities without investment. Write: **ENTERPRISES**, 1133-R Linwood Place, Utica, NY 13501

MAKE your computer pay its own way. Sample newsletter \$1. **COMPU-PROFIT**, Dept. RE2, Fairfax Station, VA 22039-0332

HIGHLY PROFITABLE ONE-MAN ELECTRONIC FACTORY
Investment unnecessary, knowledge not required, sales handled by professionals. Ideal home business. Write today for facts!
Postcard will do, Barta-RE-X, Box 248, Walnut Creek, CA 94597.

LONG-PLAY RECORDERS

RECORD up to 15 hours on a single standard cassette tape! Our modified, name-brand recorders offer the longest recording times, best long-play fidelity, and most features! Models as small as 1 1/2 pounds. Compare before you buy! Free brochures: **EXTENDO-TAPE SYSTEMS**, Box 16000LC, Temple Terrace, FL 33687

WIRELESS MICROPHONES

SURVEILLANCE-QUALITY professional wireless microphones that far outperform others. As small as 7/8"! Sold elsewhere for \$130.00. Our price only \$89.99! Also, wireless micro telephone transmitters and 15 hour recorders weighing less than 1 1/2 pounds. Free brochures. **EXTENDO-TAPE SYSTEMS**, Box 16000LC, Temple Terrace, FL 33687

* **QUALITY MICROWAVE TV SYSTEMS** *

* **Complete Systems From \$69⁹⁵** *
* **1.9 to 2.5 GHz Antennas** *
* **Galaxy Electronics** *
* **6007 N. 61st Ave.** *
* **Glendale, Az.** *
* **85301** *
* **(602) 247-1151** *
* **COD's Dealers Wanted** *
* **VISA** *
* **MasterCard** *



GOLD STAR
SILVER STAR **BRITE STAR**



STAR II

COMMUNICATIONS EQUIPMENT

VIDEOSCAN 1000 Slow Scan TV—HIGH RESOLUTION (amateur, phone line, surveillance, teleconferencing). **CODE STAR—DECODE** Morse, RTTY, ASCII. **LARGE LEDs** or connect computer/printer. **MORSE-A-KEYER—CW** keyboard. **TRI-VOLTAGE POWER SUPPLY**. Kits/Assembled. **FREE brochures. MICROCRAFT CORP.**, Box 513-RE, Thiensville, WI 53092. (414) 241-8144.

COMPUTERS

TI-99/4A owners. Send for free list of new and exciting software. **DYNA**, Box 124, Hicksville, NY 11801

CABLE TV FILTERS

SUPER powered notch filters. 70 db. Eliminate any unwanted signals. VHF channels 2-6, 14-22, A-1. Highest quality. Guaranteed. Retail or dealers. For literature write **CUSTOM COMMUNICATIONS**, P.O. Box 17621, Ft. Laud., FL 33318

HOME ASSEMBLERS WANTED

ELECTRONIC firm is looking for assemblers interested in working at home. Send \$3.00 application fee: **IRDC L'Joppa Hill Road**, Manchester, NH 03102

CONVERTERS

DELUXE sine wave UHF, parts \$175.00. Phase inversion VHF/Cable/UHF, parts \$300.00 Both have sound out of TV like normal with only antenna connection to TV or VCR. Gated pulse wave UHF (speaker box type), parts \$140.00. All have true A.G.C. Plans SASE. Quality discounts. 1-312/267-3455. **LSR ENGINEERING**, P.O. Box 6075, Chicago, IL 60680

VIC-20

"**MYSTERIOUS CASTLE**" adventure game. Designed by electrical engineer especially for VIC-20. Needs no extra memory! Cassette tape. \$23.95. Ask for free list of other games, programs. **SHANKLE PRODUCTS**, RT5, Box 373AG, Texarkana, TX 75501

TIMEX/SINCLAIR SOFTWARE

ZX-81 and **TS1000** software cheap! Catalog plus two special programs for \$1.00 and **SASE: FLORIDA CREATIONS**, RE2, Box 16422, Jacksonville, FL 32245

SINCLAIR/TIMEX COMPUTERS

YOUR Sinclair can drive a video monitor with our direct video kit, only \$9.95. 12" B & W video monitor \$98.45. **RANDOM ACCESS**, Box 41770R, Phoenix, AZ 85080

REEL TO REEL TAPES

TRUCKLOAD sale Ampex high quality open reel tape, 1800' or 2400' on 7" reels, used once. Case of 40, \$45.00. Cassettes available. **VALTECH ELECTRONICS**, Box 6-RE, Richboro, PA 18954

REVERBERATION FOR ORGANS

Solid state with controls for reverberation and room size.
EVERY ORGAN SHOULD OWN ONE. Send for free flyer—
DEVTRONIX ORGANS, INC.
6101 WAREHOUSE WAY
SACRAMENTO, CALIFORNIA 95826 Dept. B

THE BEST PLACE TO BUY, SELL or TRADE NEW and USED EQUIPMENT
NUTS & VOLTS MAGAZINE
BOX .1111-E • PLACENTIA, CA 92670
(714) 632-7721
Join Thousands of Readers Nationwide Every Month
ONE YEAR U.S. SUBSCRIPTIONS
\$7.00 - 3rd Class • \$12.50 - 1st Class
\$25.00 - Lifetime - 3rd Class

NUTS & VOLTS
HAM GEAR
COMPUTERS
SOFTWARE
SCANNERS • OPTICS
TEST EQUIPMENT
MICROWAVE
SATELLITE
AUDIO VISUAL
NEW PRODUCTS
COMPONENTS • KITS
ANTIQUE ELECT.
PUBLICATIONS
PLANS • SERVICES

SATELLITE TELEVISION

SATELLITE polar mount antenna break through, build best under \$160 metal or wood kits. **PROTOTYPE ENGINEERS**, Box 1812, Deming, NM 88030

LOOK what \$1795.00 buys: Satellite system includes receiver with modulator, 10' dish, 120° LNA, 100' cable with connectors. One year factory warranty. **SUNDOWN SATELLITE SYSTEMS**, Box C1, R.R. #1, Riverdale, NE 68870. After 4 P.M. CST call 308-893-2526

MICROWAVE antenna systems \$49.95, factory direct 24 hour shipping, **CODS**, guaranteed. **NEVADA SATELLITE CORPORATION** (702) 367-0333

SATELLITE TV low noise amplifier or downconverter. Easy to build. Save hundreds! Beautiful instruction manuals include everything you need to know. \$10.00 each. Computerized antenna pointing information **FREE** on request with each order. Satisfaction guaranteed. **XANDI**, Box 25647, Dept. 21G, Tempe, AZ 85282

Satellite ORBIT Magazine

The Complete Monthly Satellite Program Guide

\$5.00 Sample Copies Available
Satellite ORBIT

P.O. Box 1700, Hailey, ID. 83333
In the U.S., call 1-800-792-5541. In Idaho or foreign countries, 1-208-788-4936.

SATELLITE TV WEEK

The most complete weekly listings. We cover more than just SATCOM 3. **Send \$1 for sample copy.**

Satellite TV Week

P.O. Box 308, Fortuna, California 95540

Call toll free: (800) 358-9997 • California (707) 725-2476

EDUCATION & INSTRUCTION

YOUR own radio station! AM, FM, cable, licensed, unlicensed. Low cost transmitter kits, free info. **BROADCASTING**, Box 130-F3, Paradise, CA 95969

ELECTRONICS computer books. International publishers. Lowest rates. Ask list. **BUSINESS PROMOTION**, Lajpat Rai Market, Delhi, India

ATTENTION ELECTRONIC TECHNICIANS
Highly Effective Home Study BSEE Degree Program for Experienced Electronic Technicians
Our New Advanced Placement Program grants Credit for previous Schooling & Professional Experience. Advance Rapidly! Our 36th Year!
FREE DESCRIPTIVE LITERATURE!
Cook's Institute of Electronics Engineering
DESK 15, P.O. BOX 20345, JACKSON, MS 39209

Be an ELECTRONICS TECHNICIAN! Get your 2-Year ASSOCIATE DEGREE Train at home in spare time.



Choose from exciting opportunities in the fast-growing space-age industries...Automation, Aerospace, Cable-TV, Missile Design, Electronic Circuitry, Computers, Telemetry and much more. No previous experience necessary. No need to quit your job. Your Associate Degree gives you everything you need to qualify for an Electronics Technician Position. Instructors are as close as your telephone. Use our 24-hour home-study hot line—we pay the bill. Send for free facts. No obligation. No salesman will call. **Mail coupon today!**

ICS Center for Degree Studies, Dept. PF013
SINCE 1991 ICS Electronics Center, Scranton, PA 18515
Rush free facts telling how I can train to be an Electronics Technician and get my 2-year Associate Degree at home in spare time.
NAME _____ AGE _____
ADDRESS _____
CITY/STATE/ZIP _____

FOR SALE

THE Intelligence Library. Restricted technical secrets—books on **electronic surveillance, lock-picking, demotions, investigation, etc.** Free brochures: **MENTOR**, Dept. Z, 135-53 No. Blvd., Flushing, NY 11354

RESISTORS 1/4W, 1/2W 5% carbon films 3¢ ea. **NO MINIMUMS.** Cabinet assortments, 1% metal films. Request details. Bulk pricing available. **JR INDUSTRIES** 5834-C Swancreek, Toledo, OH 43614

SAVE up to 50% on name brand test equipment. Free catalog and price list. **SALEN ELECTRONICS**, Box 82-G, Skokie, IL 60077

PCB 15¢ sq-in. Free drilling. Quantity discount. **INTERNATIONAL ENTERPRISE**, 6452 Hazel Circle, Simi Valley, CA 93063

ANIK noise filter eliminates unwanted audio noise from Canadian Satellite fully assembled and guaranteed. \$65.00 & \$2.00 shipping. **ARK ELECTRONICS**, PO Box 5689, Toledo, OH 43612

FREE catalog of surplus electronic parts and hardware. **UNIVERSAL SOUND**, RES, 2253 Ringling Blvd., Sarasota, FL 33577, (813) 953-5363

FREE speaker catalog! Woofers, mids, tweeters, hardware, crossovers, grille cloths, kits, information, much more. **Discount prices.** **UNIVERSAL SOUND**, Dept. RE 2253 Ringling Blvd., Sarasota, FL 33577 (813) 953-5363

TUBES. Large selection. Unused, in original cartons. SASE brings list. **FALA ELECTRONICS**, Box 041 34-2, Milwaukee, WI 53204

MICROWAVE antennas 2100 - 2600 MHz downconverter probe 18" parabolic dish 50' cable, power supply, 6 month warranty. **MDS ASSOCIATES**, 2116-2nd Avenue North, Minneapolis, MN 55405. **JUST \$109.95**

WIND POWER an investment in the future. The right decision is essential. Information \$2.00 **WINDESIGN**, Box 138, Boston, NY 14025

TV shop closed out. Retired. Inventory for sale. Low price. **P.O. BOX 425**, San Ysidro, CA 92073

VIC 20 color 2 games on one cassette "slots" and "horse race" send \$6 to **THOMAS PROD**, 600 E. Weddell #263, Sunnyvale, CA 94086

ELECTRONIC TV - FM antenna outstanding reception. Plugs in electric outlet \$4.95 + (\$1.00 p.h.). Project your TV to giant 7 foot screen. Lens & plans \$11.00 + (\$1.50 p.h.). **MOSES IMPORTS**, 680 East 81st, Brooklyn, NY 11236 (212) 763-4585

ZX81 and **TS1000** software—for information write to: **TINSAVE SOFTWARE**, 2820 Augusta Avenue, Ontario, CA 91761

Many Happy Returns



Take stock in America.



RELIABLE MICROWAVE TV ANTENNAS

2.1 to 2.6 GHz

Frequency Range

34db System Gain (or Greater)

Complete System (pictured) \$149.95

Down Converter Probe Style

(Assembled & Tested) \$ 64.95

Power Supply (12V to 16V DC+)

(Assembled & Tested) \$ 59.95

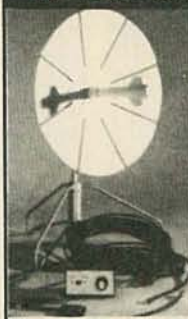

PETERSON ELECTRONICS

4558 Auburn Blvd.
Sacramento, CA 95841
(916) 486-9071

SPECIAL QUANTITY PRICING
Dealers Wanted - COD'S



1 YEAR WARRANTY
PARTS & LABOR

PAY-television manual covers cable, microwave and antennas, downconverters, descramblers. Send \$10.00 to **ST. JAMES & HARRIS**, 256 S. Robertson, Beverly Hills, CA 90211

CHRONOGRAPH circuits measure bullet velocities easily. Kits or assembled. SASE brings information. **ICD**, P.O. Box 10261 C.C. Fairbanks, AK 99701

SUBSCRIPTION TV manual, covers both sinewave and gated sync system, only \$12.95. Complete coverage including theory, circuits, waveforms, and trouble shooting units. Information \$2.00, refundable. **D & S ENTERPRISES**, Box 09292R, Cleveland, OH 44109

UNUSUAL UHF subscription TV kits. Also microwave downconverters. Catalog 50¢. **TROJAN**, 2920 Shelby, Indianapolis, IN 46203

METAL enclosure will hold S-100 M.F. power supply 2-8" or 2-5/4" drives with mounting hardware. Unpainted \$65.00. Painted \$75.00. **A.B.M.**, Box 144, Hessmer, LA 71341, 318-563-4428



WRITE FOR
McGEE'S
SPEAKER & ELECTRONICS CATALOG

1001 BARGAINS IN SPEAKERS

Tel.: 1 (816) 842 5092

1901 MCGEE STREET KANSAS CITY, MO. 64108

CABLE TV SECRETS—the outlaw publication the cable companies tried to ban. HBO, Movie Channel, Showtime, descramblers, converters, etc. Suppliers list included. Send \$7.95 to **CABLE FACTS**, Box 711-R, Pataskala, OH 43062

COLOR computer VIC-20 programs hardware RTTY code EPROM Programmer RS-232, **FRANK LYMAN**, Box 3091, Nashua, NH 03061

FAST, dependable mail-order! Prime semiconductors, parts, supplies. **Free 55 Page catalog.** **THE PARTSTORE**, Dept. 165, 999 44th St., Marion, IA 52302. (319) 373-1803

ADVENT TV Parts. All models, all parts. **ADVENTRONICS**, 499 Medford, Somerville, Mass. 02145. 617-623-5039



START MAKING MONEY IN COMPUTER REPAIR

Train at home in spare time. No previous experience needed. Experts show you what to do, how to do it! Even beginners can learn how to repair small computers. Everything explained in easy-to-understand language. You learn by doing with tools and materials included in your course. Easy home-study plan shows how you can get in on ground floor of this fast-growing business.

MAIL COUPON TODAY!
There's no obligation
and no salesman will call.

ICS SINCE 1981 **SCHOOL OF COMPUTER REPAIR**, Dept. DE023
Scranton, Pennsylvania 18515

Yes! I want to get into computer repair. Rush me free facts and color brochure.

Name _____ Age _____
Address _____
City/State/Zip _____

MORE GAIN

THAN A VARACTOR UHF TUNER



SATISFACTION

GUARANTEED

\$15.00

Freq. Range UHF470-

889MHz Channels 14-83

Output Channel 3.

Available on request: Ch 2 or 4.

Part No. B20

Modified High Gain Tuner. **\$15.00**

1. The first thing we do is change the standard diode found in every tuner to a Hot Carrier Diode.
2. The tuners output is then measured and compared to our computer derived chart from which we determine the correct value coil to add across the IF output for maximum Pre-Peaked gain.
3. The tuner is fed a standard 10db antenna input, and while monitoring the output on our Spectrum Analyzer, the tuner is tuned to the desired channel and its oscillator is offset for the desired output frequency as follows:

Ch. 2:58Mhz Ch. 3: 63Mhz Ch. 4: 68Mhz

We call this step peaking because the tuners output looks like a peak on our spectrum analyzer and the highest point of that peak is actually adjusted for the desired output.

4. Finally, we measure the tuners output one more time which is again compared to our computer derived performance chart to ascertain the correct value of the second coil which is added to the tuners internal connections.

This procedure was developed by GILCO and its computer derived performance charts that make our tuner better. That's because almost every tuner gets a different value coil before it's peaked and then a different value coil after it's peaked. The combinations are endless and the way we determine the values is our secret.

PRINTED CIRCUIT BOARDS

Part No. B21 Printed Circuit Board. **\$17.00**

1. This Printed Circuit Board uses only one jumper, others use 9.
2. The component layout is screen printed on the Component side of the pre-drilled P/C Board.
3. The solder side of the P/C Board is covered with High Temperature Solder Resist for ease of assembly.
4. This P/C board was designed to take advantage of the Gilco High Gain Tuner which means its circuitry is simpler and more efficient than those circuits that require inferior Varactor Tuners.

ELECTRONIC PARTS KITS

Part No. B22 Complete Parts Kit. **\$80.00**

All resistors (30). Potentiometers (1-5K, 3-10K), Panel Mount Potentiometer (10K), Electrolytic Capacitors (6), Ceramic and Mylar Disc Capacitors (35), Variable Capacitors (4), All Integrated Circuits (7), Voltage Regulator, Heat Sink, Diodes (4), IC Sockets (4-8 pin, 3-14 pin), Power Transformer (24V/1A), Coil Kit with No. 26 wire (4), Speaker (4"-3 Oz.), Standoffs, Coaxial cable, All misc. Hardware, etc. All parts are individually packaged and labeled.

All components including the wire, Hardware, Coaxial Cable and heat sinks are included in the parts kit. This means your assembly time from start to finish is only 4 hours.

Order all 3, B20, B21, B22. **110.00**

Order 5 each, B20, B21, B22. **95.00/set**

ACCESSORIES: AMPLIFIERS

| Part No. | Description | Kit Price |
|----------|--|--------------------|
| A02 | New 2 Stage Low Noise 28db gain RF Amplifier Specially designed for kit builders | Kit \$18.00 |
| A03 | New 1 Stage Low Noise 14db gain Amplifier | Kit \$10.50 |
| A04 | 75-300 OHM matching Transformer. | \$1.00 |
| F59 | Coaxial Connectors. | .30 |

Mail order only. Send check or money order to:
GILCO INTERNATIONAL, INC.
P. O. Box 8817, Coral Gables, FL 33124
Tel. (305) 823-5891 For COD orders add 10% shipping and handling or for orders over \$50, add 5%.
FL residents add 5% sales tax. Please write for more information

MARCH 1983

ACTIVE RECEIVING ANTENNA

Gives excellent reception, 50 KHz to 30 MHz.

New MFJ-1024 Active Receiving Antenna mounts outdoors away from electrical noise for maximum signal. Gives excellent reception of 50 KHz to 30 MHz signals. Equivalent to wire hundreds of feet long. Use any SWL, MW, BCB, VLF or Ham receiver. High dynamic range RF amplifier. 54 in. whip. 50 foot coax. 20 dB attenuator prevents receiver overload. Switch between two receivers. Select auxiliary or active antenna. Gain control. "ON" LED. Remote unit, 3x2x4 in. Control, 6x2x5 in. 12 VDC or 110 VAC with optional adapter, MFJ-1312, \$9.95.



\$129.95 (+\$4.00 shipping)

Order from MFJ and try it. If not delighted, return within 30 days for refund (less shipping). One year unconditional guarantee. Order today. Call TOLL FREE 800-647-1800. Charge VISA, MC. Or mail check, money order. Write for free catalog. Over 100 products.

CALL TOLL FREE 800-647-1800

Call 601-323-5869 in Miss., outside continental USA, tech/order/repair info. TELEX 53-4590.

MFJ ENTERPRISES, INCORPORATED

Box 494, Mississippi State, MS 39762

CIRCLE 79 ON FREE INFORMATION CARD

SCR

Free Buyers Guide
84 pages of the latest in components, tools and instruments — a must for DESIGNERS, instructors and maintenance engineers.

NEW ZENITH ZXM 121

High legibility 12" green phosphor monitor. 15 MHz bandwidth, 40 or 80 character selectable full compatibility. **\$99.95**

SPECIALS
25 PIN DB PLUG AMP P/N 205737-2
Any Quantity **\$1.97**

9 PIN DB PLUG RIGHT ANGLE FOR HOME COMPUTERS & GAMES!
AMP P/N 207456-2
Any Quantity **\$.85**

RESISTOR BUYOUT
MOST STANDARD VALUES
1/4 WATT 5% RESISTORS 1 OHM TO 10 MEG. OHM
2 K MIN. BUY 1 K MIN. PER VALUE
\$6.50 Per 1,000

UHF/VHF Conversion Kit — with Genuine Mitsumi Tuner **\$119.95**

CALL OUR HOT LINES
IN CALIF. (714) 527-2554
OUTSIDE CAL. (800) 854-8660
SCR ELECTRONICS CENTER
5303 Lincoln Ave., Cypress, CA 90630

CIRCLE 64 ON FREE INFORMATION CARD

C/MOS

| | | | | | | | |
|------|----|------|------|-------|------|-------|------|
| 4001 | 25 | 4038 | 35 | 4081 | 25 | 74C42 | 1.00 |
| 4002 | 25 | 4039 | 35 | 4082 | 25 | 74C43 | 1.00 |
| 4003 | 27 | 4034 | 1.75 | 4083 | 25 | 74C44 | 1.00 |
| 4008 | 27 | 4035 | 1.75 | 4084 | 25 | 74C45 | 1.00 |
| 4009 | 27 | 4040 | 65 | 4085 | 1.75 | 74C46 | 1.00 |
| 4010 | 25 | 4042 | 55 | 4086 | 25 | 74C47 | 1.00 |
| 4011 | 22 | 4043 | 65 | 4087 | 1.75 | 74C48 | 1.00 |
| 4012 | 22 | 4044 | 55 | 4088 | 1.75 | 74C49 | 1.00 |
| 4013 | 25 | 4046 | 65 | 4089 | 1.75 | 74C50 | 1.00 |
| 4014 | 27 | 4047 | 35 | 4090 | 1.75 | 74C51 | 1.00 |
| 4015 | 25 | 4049 | 35 | 4091 | 1.75 | 74C52 | 1.00 |
| 4016 | 25 | 4050 | 35 | 4092 | 1.25 | 74C53 | 1.00 |
| 4017 | 30 | 4051 | 80 | 4093 | 1.25 | 74C54 | 1.00 |
| 4018 | 25 | 4052 | 35 | 4094 | 1.25 | 74C55 | 1.00 |
| 4019 | 38 | 4053 | 75 | 74C00 | 25 | 74C12 | 1.00 |
| 4020 | 25 | 4054 | 65 | 74C01 | 25 | 74C13 | 1.00 |
| 4021 | 25 | 4056 | 35 | 74C02 | 27 | 74C14 | 1.00 |
| 4022 | 25 | 4057 | 35 | 74C03 | 27 | 74C15 | 1.00 |
| 4023 | 25 | 4058 | 35 | 74C04 | 27 | 74C16 | 1.00 |
| 4024 | 25 | 4059 | 35 | 74C05 | 27 | 74C17 | 1.00 |
| 4025 | 25 | 4060 | 35 | 74C06 | 27 | 74C18 | 1.00 |
| 4026 | 25 | 4061 | 35 | 74C07 | 27 | 74C19 | 1.00 |
| 4027 | 25 | 4062 | 35 | 74C08 | 27 | 74C20 | 1.00 |
| 4028 | 25 | 4063 | 35 | 74C09 | 27 | 74C21 | 1.00 |
| 4029 | 25 | 4064 | 35 | 74C10 | 27 | 74C22 | 1.00 |
| 4030 | 25 | 4065 | 35 | 74C11 | 25 | 74C23 | 1.25 |
| 4031 | 25 | 4066 | 35 | 74C12 | 25 | 74C24 | 1.25 |
| 4032 | 25 | 4067 | 35 | 74C13 | 25 | 74C25 | 1.25 |
| 4033 | 25 | 4068 | 35 | 74C14 | 25 | 74C26 | 1.25 |
| 4034 | 25 | 4069 | 35 | 74C15 | 25 | 74C27 | 1.25 |
| 4035 | 25 | 4070 | 35 | 74C16 | 25 | 74C28 | 1.25 |
| 4036 | 25 | 4071 | 35 | 74C17 | 25 | 74C29 | 1.25 |
| 4037 | 25 | 4072 | 35 | 74C18 | 25 | 74C30 | 1.25 |
| 4038 | 25 | 4073 | 35 | 74C19 | 25 | 74C31 | 1.25 |
| 4039 | 25 | 4074 | 35 | 74C20 | 25 | 74C32 | 1.25 |
| 4040 | 25 | 4075 | 35 | 74C21 | 25 | 74C33 | 1.25 |
| 4041 | 25 | 4076 | 35 | 74C22 | 25 | 74C34 | 1.25 |
| 4042 | 25 | 4077 | 35 | 74C23 | 25 | 74C35 | 1.25 |

TRANSISTOR SPECIALS

| | |
|---------------------|-------|
| 2N1307 PNP GE TO-18 | \$ 40 |
| 2N1308 PNP GE TO-18 | \$ 40 |
| 2N1309 PNP GE TO-18 | \$ 40 |
| 2N1310 PNP GE TO-18 | \$ 40 |
| 2N1311 PNP GE TO-18 | \$ 40 |
| 2N1312 PNP GE TO-18 | \$ 40 |
| 2N1313 PNP GE TO-18 | \$ 40 |
| 2N1314 PNP GE TO-18 | \$ 40 |
| 2N1315 PNP GE TO-18 | \$ 40 |
| 2N1316 PNP GE TO-18 | \$ 40 |
| 2N1317 PNP GE TO-18 | \$ 40 |
| 2N1318 PNP GE TO-18 | \$ 40 |
| 2N1319 PNP GE TO-18 | \$ 40 |
| 2N1320 PNP GE TO-18 | \$ 40 |
| 2N1321 PNP GE TO-18 | \$ 40 |
| 2N1322 PNP GE TO-18 | \$ 40 |
| 2N1323 PNP GE TO-18 | \$ 40 |
| 2N1324 PNP GE TO-18 | \$ 40 |
| 2N1325 PNP GE TO-18 | \$ 40 |
| 2N1326 PNP GE TO-18 | \$ 40 |
| 2N1327 PNP GE TO-18 | \$ 40 |
| 2N1328 PNP GE TO-18 | \$ 40 |
| 2N1329 PNP GE TO-18 | \$ 40 |
| 2N1330 PNP GE TO-18 | \$ 40 |
| 2N1331 PNP GE TO-18 | \$ 40 |
| 2N1332 PNP GE TO-18 | \$ 40 |
| 2N1333 PNP GE TO-18 | \$ 40 |
| 2N1334 PNP GE TO-18 | \$ 40 |
| 2N1335 PNP GE TO-18 | \$ 40 |
| 2N1336 PNP GE TO-18 | \$ 40 |
| 2N1337 PNP GE TO-18 | \$ 40 |
| 2N1338 PNP GE TO-18 | \$ 40 |
| 2N1339 PNP GE TO-18 | \$ 40 |
| 2N1340 PNP GE TO-18 | \$ 40 |
| 2N1341 PNP GE TO-18 | \$ 40 |
| 2N1342 PNP GE TO-18 | \$ 40 |
| 2N1343 PNP GE TO-18 | \$ 40 |
| 2N1344 PNP GE TO-18 | \$ 40 |
| 2N1345 PNP GE TO-18 | \$ 40 |
| 2N1346 PNP GE TO-18 | \$ 40 |
| 2N1347 PNP GE TO-18 | \$ 40 |
| 2N1348 PNP GE TO-18 | \$ 40 |
| 2N1349 PNP GE TO-18 | \$ 40 |
| 2N1350 PNP GE TO-18 | \$ 40 |
| 2N1351 PNP GE TO-18 | \$ 40 |
| 2N1352 PNP GE TO-18 | \$ 40 |
| 2N1353 PNP GE TO-18 | \$ 40 |
| 2N1354 PNP GE TO-18 | \$ 40 |
| 2N1355 PNP GE TO-18 | \$ 40 |
| 2N1356 PNP GE TO-18 | \$ 40 |
| 2N1357 PNP GE TO-18 | \$ 40 |
| 2N1358 PNP GE TO-18 | \$ 40 |
| 2N1359 PNP GE TO-18 | \$ 40 |
| 2N1360 PNP GE TO-18 | \$ 40 |
| 2N1361 PNP GE TO-18 | \$ 40 |
| 2N1362 PNP GE TO-18 | \$ 40 |
| 2N1363 PNP GE TO-18 | \$ 40 |
| 2N1364 PNP GE TO-18 | \$ 40 |
| 2N1365 PNP GE TO-18 | \$ 40 |
| 2N1366 PNP GE TO-18 | \$ 40 |
| 2N1367 PNP GE TO-18 | \$ 40 |
| 2N1368 PNP GE TO-18 | \$ 40 |
| 2N1369 PNP GE TO-18 | \$ 40 |
| 2N1370 PNP GE TO-18 | \$ 40 |
| 2N1371 PNP GE TO-18 | \$ 40 |
| 2N1372 PNP GE TO-18 | \$ 40 |
| 2N1373 PNP GE TO-18 | \$ 40 |
| 2N1374 PNP GE TO-18 | \$ 40 |
| 2N1375 PNP GE TO-18 | \$ 40 |
| 2N1376 PNP GE TO-18 | \$ 40 |
| 2N1377 PNP GE TO-18 | \$ 40 |
| 2N1378 PNP GE TO-18 | \$ 40 |
| 2N1379 PNP GE TO-18 | \$ 40 |
| 2N1380 PNP GE TO-18 | \$ 40 |
| 2N1381 PNP GE TO-18 | \$ 40 |
| 2N1382 PNP GE TO-18 | \$ 40 |
| 2N1383 PNP GE TO-18 | \$ 40 |
| 2N1384 PNP GE TO-18 | \$ 40 |
| 2N1385 PNP GE TO-18 | \$ 40 |
| 2N1386 PNP GE TO-18 | \$ 40 |
| 2N1387 PNP GE TO-18 | \$ 40 |
| 2N1388 PNP GE TO-18 | \$ 40 |
| 2N1389 PNP GE TO-18 | \$ 40 |
| 2N1390 PNP GE TO-18 | \$ 40 |
| 2N1391 PNP GE TO-18 | \$ 40 |
| 2N1392 PNP GE TO-18 | \$ 40 |
| 2N1393 PNP GE TO-18 | \$ 40 |
| 2N1394 PNP GE TO-18 | \$ 40 |
| 2N1395 PNP GE TO-18 | \$ 40 |
| 2N1396 PNP GE TO-18 | \$ 40 |
| 2N1397 PNP GE TO-18 | \$ 40 |
| 2N1398 PNP GE TO-18 | \$ 40 |
| 2N1399 PNP GE TO-18 | \$ 40 |
| 2N1400 PNP GE TO-18 | \$ 40 |
| 2N1401 PNP GE TO-18 | \$ 40 |
| 2N1402 PNP GE TO-18 | \$ 40 |
| 2N1403 PNP GE TO-18 | \$ 40 |
| 2N1404 PNP GE TO-18 | \$ 40 |
| 2N1405 PNP GE TO-18 | \$ 40 |
| 2N1406 PNP GE TO-18 | \$ 40 |
| 2N1407 PNP GE TO-18 | \$ 40 |
| 2N1408 PNP GE TO-18 | \$ 40 |
| 2N1409 PNP GE TO-18 | \$ 40 |
| 2N1410 PNP GE TO-18 | \$ 40 |
| 2N1411 PNP GE TO-18 | \$ 40 |
| 2N1412 PNP GE TO-18 | \$ 40 |
| 2N1413 PNP GE TO-18 | \$ 40 |
| 2N1414 PNP GE TO-18 | \$ 40 |
| 2N1415 PNP GE TO-18 | \$ 40 |
| 2N1416 PNP GE TO-18 | \$ 40 |
| 2N1417 PNP GE TO-18 | \$ 40 |
| 2N1418 PNP GE TO-18 | \$ 40 |
| 2N1419 PNP GE TO-18 | \$ 40 |
| 2N1420 PNP GE TO-18 | \$ 40 |
| 2N1421 PNP GE TO-18 | \$ 40 |
| 2N1422 PNP GE TO-18 | \$ 40 |
| 2N1423 PNP GE TO-18 | \$ 40 |
| 2N1424 PNP GE TO-18 | \$ 40 |
| 2N1425 PNP GE TO-18 | \$ 40 |
| 2N1426 PNP GE TO-18 | \$ 40 |
| 2N1427 PNP GE TO-18 | \$ 40 |
| 2N1428 PNP GE TO-18 | \$ 40 |
| 2N1429 PNP GE TO-18 | \$ 40 |
| 2N1430 PNP GE TO-18 | \$ 40 |
| 2N1431 PNP GE TO-18 | \$ 40 |
| 2N1432 PNP GE TO-18 | \$ 40 |
| 2N1433 PNP GE TO-18 | \$ 40 |
| 2N1434 PNP GE TO-18 | \$ 40 |
| 2N1435 PNP GE TO-18 | \$ 40 |
| 2N1436 PNP GE TO-18 | \$ 40 |
| 2N1437 PNP GE TO-18 | \$ 40 |
| 2N1438 PNP GE TO-18 | \$ 40 |
| 2N1439 PNP GE TO-18 | \$ 40 |
| 2N1440 PNP GE TO-18 | \$ 40 |
| 2N1441 PNP GE TO-18 | \$ 40 |
| 2N1442 PNP GE TO-18 | \$ 40 |
| 2N1443 PNP GE TO-18 | \$ 40 |
| 2N1444 PNP GE TO-18 | \$ 40 |
| 2N1445 PNP GE TO-18 | \$ 40 |
| 2N1446 PNP GE TO-18 | \$ 40 |
| 2N1447 PNP GE TO-18 | \$ 40 |
| 2N1448 PNP GE TO-18 | \$ 40 |
| 2N1449 PNP GE TO-18 | \$ 40 |
| 2N1450 PNP GE TO-18 | \$ 40 |

TTL IC SERIES

| | | | | | |
|------|----|------|------|-------|------|
| 7400 | 17 | 7472 | 30 | 74812 | 60 |
| 7401 | 17 | 7473 | 30 | 74813 | 60 |
| 7402 | 17 | 7474 | 32 | 74814 | 60 |
| 7403 | 17 | 7475 | 40 | 74815 | 60 |
| 7404 | 24 | 7476 | 35 | 74816 | 70 |
| 7405 | 24 | 7477 | 40 | 74817 | 60 |
| 7406 | 28 | 7478 | 50 | 74818 | 75 |
| 7407 | 28 | 7479 | 55 | 74819 | 65 |
| 7408 | 24 | 7480 | 35 | 74820 | 60 |
| 7409 | 18 | 7481 | 1.00 | 74821 | 75 |
| 7410 | 17 | 7482 | 35 | 74822 | 1.00 |
| 7411 | 22 | 7483 | 45 | 74823 | 85 |
| 7412 | 30 | 7484 | 45 | 74824 | 85 |
| 7413 | 35 | 7485 | 45 | 74825 | 85 |
| 7414 | 45 | 7486 | 45 | 74826 | 85 |
| 7415 | 25 | 7487 | 55 | 74827 | 85 |
| 7416 | 25 | 7488 | 60 | 74828 | 85 |
| 7417 | 25 | 7489 | 60 | 74829 | 85 |
| 7418 | 17 | 7490 | 1.00 | 74830 | 85 |
| 7419 | 25 | 7491 | 1.50 | 74831 | 1.00 |
| 7420 | 25 | 7492 | 1.50 | 74832 | 85 |
| 7421 | 25 | 7493 | 1.50 | 74833 | 85 |
| 7422 | 25 | 7494 | 1.50 | 74834 | 85 |
| 7423 | 25 | 7495 | 1.50 | 74835 | 85 |
| 7424 | 25 | 7496 | 1.50 | 74836 | 85 |
| 7425 | 25 | 7497 | 1.50 | 74837 | 85 |
| 7426 | 25 | 7498 | 1.50 | 74838 | 85 |
| 7427 | 25 | 7499 | 1.50 | 74839 | 85 |
| 7428 | 17 | 7500 | 1.00 | 74840 | 85 |
| 7429 | 17 | 7501 | 1.00 | 74841 | 85 |
| 7430 | 17 | 7502 | 1.00 | 74842 | 85 |
| 7431 | 17 | 7503 | 1.00 | 74843 | 85 |
| 7432 | 17 | 7504 | 1.00 | 74844 | 85 |
| 7433 | 17 | 7505 | 1.00 | 74845 | 85 |
| 7434 | 17 | 7506 | 1.00 | 74846 | 85 |
| 7435 | 17 | 7507 | 1.00 | 74847 | 85 |
| 7436 | 17 | 7508 | 1.00 | 74848 | 85 |
| 7437 | 17 | 7509 | 1.00 | 74849 | 85 |
| 7438 | 17 | 7510 | 1.00 | 74850 | 85 |
| 7439 | 17 | 7511 | 1.00 | 74851 | 85 |
| 7440 | 17 | 7512 | 1.00 | 74852 | 85 |
| 7441 | 17 | 7513 | 1.00 | 74853 | 85 |
| 7442 | 17 | 7514 | 1.00 | 74854 | 85 |
| 7443 | 17 | 7515 | 1.00 | 74855 | 85 |
| 7444 | 17 | 7516 | 1.00 | 74856 | 85 |
| 7445 | 17 | 7517 | 1.00 | 74857 | 85 |
| 7446 | 17 | 7518 | 1.00 | 74858 | 85 |
| 7447 | 17 | 7519 | 1.00 | 74859 | 85 |
| 7448 | 17 | 7520 | 1.00 | 74860 | 85 |
| 7449 | 17 | 7521 | 1.00 | 74861 | 85 |
| 7450 | 17 | 7522 | 1.00 | 74862 | 85 |

DOUBLE SIDED DIP RIBBON CABLE JUMPER ASSEMBLIES

16 PIN 4" LONG \$ 2.00
14 PIN 12" LONG \$ 2.50

RS 232 CABLE

10 Conductor, #22 color coded wire, gray PVC outer cover, 3/8" diameter, 40 per ft. — 100, \$30.00
Add 20% postage for orders under 100'.
Add 10% postage for orders over 100'.

SPECIALS

| | | | |
|---------|--------|-----------|---------|
| 6502 | \$6.00 | TMS9927NL | \$ 9.95 |
| 8080A | 2.75 | 6845 | 13.95 |
| 280A | 3.75 | 8275 | 16.95 |
| 68000L8 | 90.00 | | |

CRT Controllers

| | |
|---------|---------|
| 2732 | \$ 6.50 |
| MC8764C | 19.95 |

RAM's

| | |
|----------------|--------|
| 2114L-4 | \$1.35 |
| 4116-2 | 1.60 |
| MK4802-J3-2KX8 | 8.95 |
| 93L422BIPOLAR | 5.95 |
| 4164-2-64K | 6.25 |
| 2147 J3 | 4.95 |
| 4118-4 | 6.95 |

DISC Controllers

| | |
|------|--|
| 1771 | |
|------|--|

QUALITY
SERVICE
AVAILABILITY



ACTIVE, YOUR
NUMBER ONE
CHOICE

Active Electronic

Active Electronics

Your one stop source for the
widest variety of factory
fresh electronic components

FEATURING
THE 1982 I.C. MASTER
\$39.95
WHILE QUANTITIES LAST

Extensive Product Offering

Semiconductors, Integrated Circuits, Micro-
computer Boards, Microprocessor and
Support Circuits, Transistors, Diodes,
Capacitors, Resistors, Optoelectronics,
Potentiometers, Relays, Multimeters,
Switches, Knobs, Connectors, Sockets, P.C.
Boards, Enclosures, Data and Reference
Books, Soldering Aids, AND MUCH MORE

Superior Service

Greater choice. Easier, faster ordering and more
reliable deliveries. Active's all NEW comprehensive
Fall/Winter catalog is now available — FREE OF
CHARGE. Circle No. **3** on free information card or
write to: P.O. Box 8000, Westboro, MASS. 01581 U.S.A.

Call Toll Free 800-343-0874
MASS. customers call (617) 366-0500

CIRCLE 3 ON FREE INFORMATION CARD

More BLOCKBUSTER BARGAINS!!

Parallel, TTL Input I/O "Selectric"® TYPEWRITER / PRINTER

The manufacturer put 'em into storage to
depreciate 'em. Now they're **FINALLY
AVAILABLE!!** Removed from working
systems, these fantastic machines have
built-in driver and decoder circuitry and
take TTL level, 6-bit character, plus 4-bit
function input signals. Easily driven by
most any micro. Use as a typewriter (with
add'l 'repeat' circuitry) or as a KSR I/O
printer or both. Requires 115, 60Hz for type-
writer motor, 5 VDC for TTL and 24 VDC for solenoids. "Table Top" style case. Each
"Selectric" I/O machine is complete and in **operational condition!** Includes schematics,
data, case, platen and ribbon.



TESTED &
OPERATIONAL!

Type Element \$21.00ea. I/O Selectric **\$399.00ea.**
Add \$20 for Packaging and Handling - Pay Shipping on Delivery

SAVE!! Untested version of the above, otherwise whole & complete. May require some
service. **\$279.00ea.**

Used, Off-Lease PRINTER TERMINALS

GE "Terminet 1200"
Band Printer
Terminal

Featuring:

- 1200 Baud, RS-232 ASCII 96 (upper & lower case) FULLY FORMED characters at up to 120 chars./sec. 120 columns wide!
- Letter Quality Print at Dot Matrix Speed!
- 150, 300 & 1200 BAUD Serial Input Rate
- Built & Serviced NATIONWIDE by General Electric (GE)



WITH
DATA

Forms Tractor not included
(Available from General Electric)

TESTED & OPERATIONAL!! Current NEW price over \$5000⁰⁰ each. Our Price **\$295⁰⁰ea.**

Please Add \$20.00 for Packaging & Handling - Shipped Truck, Freight, Collect

RS-232 CABLE with female DB-25 connectors on each end, (female connector has pins, male has sockets) for interfacing the above. **\$19.00ea.**

We Offer New & Used FLOPPY DRIVES, DISK DRIVES, PRINTERS, & MORE at BARGAIN PRICES!!
Write or Call for Our Latest Flyer NOW!!

"Selectric" is a registered trademark of IBM Corporation

Computer
Products &
Peripherals
Unlimited

WAREHOUSE: 18 Granite St. Haverhill, Mass. 01830
MAIL ORDERS: Box 204, Newton, New Hampshire 03858

617/372-8637

Sorry, No Collect Calls
MasterCard & VISA Accepted

CIRCLE 62 ON FREE INFORMATION CARD

12" B&W MONITOR

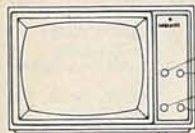

Contrast
Power/Bright
V-Hold
H-Hold

VIDEO 100 by AMDEK

FULL
FACTORY
WARRANTY **\$79⁹⁵**

for APPLE

16K RAM CARD

Language Transparent
COEX FACTORY
WARRANTY **\$69⁹⁵**

5 1/4" Floppy DISKETTES

All Certified-100% Guaranteed

BOX of 100 ... **\$149⁰⁰**
Above with
Hub Rings **\$169.00**

FLOPPY DISK DRIVE

From Fourth Dimension Systems

- with • Track Zero Micro Switch
- DOS 3.2.1 & DOS 3.3
- CP/M and PASCAL

DESIGNED
FOR YOUR
APPLE™ **\$287⁹⁵**

Controller Card
for above **\$99.00**

COEX 80-FT DOT MATRIX PRINTER

- Interface with Apple™, Centronics RS-232, IEEE-488
- 9x7 Dot Matrix, 80 CPS, Bi-Directional Printing
- 2K Buffered Memory
- 80, 96, 132 Columns, Graphics and Block Printing
- Selectable Char Pitch, Line Spacing and Feed

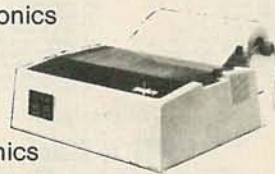

COEX Interface Card to APPLE **\$49.95**

\$349⁰⁰

VISION-80® **\$249⁰⁰**

80x24 Video Display Card
Vista Computer Company's new Vision-80 board is a sophisticated yet easy to use video display card for the Apple™ computer.

PARALLEL INTERFACE EPSON TO APPLE

New From **\$49⁹⁵** CABLE
COEX INCLUDED

PROTOTYPING CARDS

for APPLE.... **\$19.95**
for I.B.M. **\$49.95**

EXTENDER CARDS

for APPLE... **\$16.95**
for I.B.M. **\$19.95**

"Have You Kissed Your Computer Lately?"

Components Express, Inc.



1380 E. Edinger • Santa Ana, Calif. 92705 • 714/558-3972

Terms of Sale: Cash, Checks, Credit Cards, M.O., C.O.D. Calif. residents add 6% sales tax.

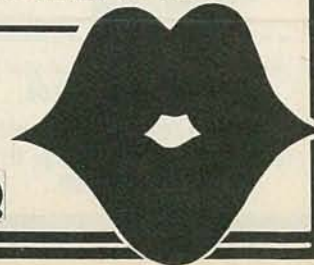

MARCH 1983



ELECTRONICS CO., INC.

FREE CATALOG

32 pages with 47 exciting, low cost electronic projects!
at your local electronics store

CALL for store nearest you
1-800-453-1708



SEE

these electronic kits in
 Kit Centers throughout the
 U.S.A.

- | | |
|--------------------------------------|--|
| 801 Pocket Dice | 842 12-volt Color Organ |
| 802 Signal Injector | 844 T.V. Jammer |
| 803 Space War Gun | 846 12-volt Strobe Stick |
| 804 Metal Detector | 850 Whopper Alarm |
| 805 Logic Probe | 852 Combination Lock/Alarm Control |
| 806 Burglar Alarm | 855 Electronic Tennis |
| 808 Decision Maker | 858 Digital Roulette |
| 809 LED Pendulum Metronome | 860 5-24 Volt Regulated Power Supply |
| 811 Double Decision Maker | 861 Big Sound Portable Control |
| 812 Siren Oscillator | 862 Full-wave Motor Speed Control |
| 814 Robot Blinder | 865 Digital Slot Machine |
| 816 Mini-funk | 868 Digital Dice |
| 818 Fish Caller | 870 Nerve Tester |
| 820 Shimmer Lights | 876 6-digit Digital Clock |
| 821 Christmas Tree | 878 Digital Bird |
| 822 One Channel Color Organ | 880 12-volt 2-amp Regulated Power Supply |
| 824 Automatic Siren | 882 Medical Horn |
| 826 Fuzz Box | 884 Sound Activated Color Organ, 1-channel |
| 828 9-Volt Power Supply | 885 Audio Amp/Intercom |
| 830 Multi-purpose Power Supply | 888 Laser Terminator |
| 834 Color Organ 3-channel, 1-control | 890 Stop-action Timing Tester |
| 835 3-channel, 4-control Color Organ | 892 Telephone Hold Button |
| 840 Variable Strobe Light | 894 Phasor Gun/Sound Generator |
| | 898 Binary Clock |

Also available
PPG's Basic Electronics Course

NEW
 from PPG Electronics
BODY BLINKER
 available NOW!
 for only
\$5.95

Allow 2 weeks for delivery of your FREE
 1982-83 PPG CATALOG.
 PPG ELECTRONICS CO., INC.
 791 Red Rock Road, St. George, UT 84770
 1-801-628-3627

BEC BULLET ELECTRONICS

P.O. BOX 401244R GARLAND, TX. 75040 (214) 487-9031

Sound Effects Kit \$18.50

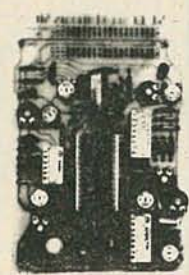

The SE-01 is a complete kit that contains all the parts to build a programmable sound effects generator. Designed around the new Texas Instruments SN741877 Sound Chip, the board provides banks of MINI-DIP switches and pots to program the various combinations of the S.F. Oscillator, VCO, Noise, One Shot, and Envelope Controls. A Quad Op Amp IC is used to implement an Adjustable Pulse Generator, Level Comparator, and Multiple Oscillator for even more versatility. The 3" x 5" PC Board features a prototype area to allow for user added circuitry. Easily programmed to duplicate Explosions, Phasor Guns, Siren Trains, or almost an infinite number of other sounds. The unit has a multiple of applications. The low price includes all parts, assembly manual, programming charts, and detailed 78477 chip specifications. It runs on a 9V battery (not included). On board 100mW amp will drive a small speaker directly, or the unit can be connected to your stereo with microphone receiver (speaker not included). 78477 is included. Available separately for \$3.15 each.

The Super Music Maker REVISION 2 \$24.95 (Basic Kit) SEE SPECIAL OFFER BELOW

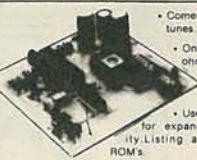

- Comes with 25 pre-programmed tunes
- On board 7 watt amplifier drives 8 ohm speaker directly
- Works on 12VAC or 12 VDC
- Uses either 2708 or 2716 EPROM for expanded tune playing capability. Listing available pre-programmed ROM's

A true electronic music maker based on a microprocessor chip. The Super Music Maker is the only kit that allows easy addition of pre-programmed tunes by plugging in one memory chip (ROM). Over 20 different ROM's with over 500 tunes are available. Use the kit for a Car Horn, Doorbell, Door Announcer, etc. If you have an EPROM programmer our manual tells you how to program your own tunes. Kit includes quality plated and drilled PC Board and all components.

OPTIONAL ACCESSORIES

| | |
|--|-----------|
| DIP SWITCHES One 8 pos., one 5 pos., for tune address | 2.00/3.00 |
| WALL PLUG TRANSFORMER For operation on 117VAC house current | 3.00 |
| INJECTION MOLDED PLASTIC CASE w/custom front & rear panels, hardware and 2 live pos. rotary switches (replaces DIP switches) | 8.00 |
| HORN SPEAKER 8 watt, 8 Ohm, with mounting bracket | 6.25 |

SPECIAL OFFER
 Buy a Super Music Maker kit for \$24.95 and get FREE, a 2708 ROM pre-programmed with 35 popular tunes. This offer gives you over 60 songs to choose from!

7 Watt Audio Amp Kit \$6.95

SMALL, SINGLE HYBRID IC AND COMPONENTS FIT ON A 2" x 3" PC BOARD (INCLUDED). RUNS ON 12VDC. GREAT FOR ANY PROJECT THAT NEEDS AN INEXPENSIVE AMP. LESS THAN 3% THD @ 5 WATTS. COMPATIBLE WITH SE-01 SOUND KIT.

Doomsday Alarm Kit \$9.95

If you have trouble sleeping and you would like the rest of the neighborhood to share your misery then this little kit will be for you! There is no way to accurately describe the unearthly howls, screams and tones that come out of this kit. Four separate tone oscillators are mixed, cancelled and stepped at a varying rate. 10 Watts of crazy sounds. A great fun kit or a practical burglar alarm. Complete with PC board and all necessary components less speaker. For 6-12 VDC. ORDER DA-02.

THE PRESIDENT SAYS: "HOGWASH!!!"

After taking one look at the TRIPUD POWER SUPPLY our engineer declared that the units were worth several hundred dollars each. He pointed out the engineering, high quality construction and state-of-the-art integrated design in support of his position. The President of BEC more pragmatically pointed out the already full warehouse and the two trailer truck loads of power supplies waiting in the parking lot, and set the price to move them QUICKLY!

3 OUTPUTS
 12V @ 8A (12A Int.)
 5V @ 10A
 -12V @ 5A
 INPUT 105 - 125VAC

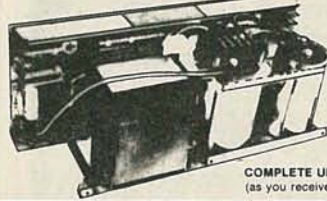

62.50
 Plus \$5.00 Freight
 21 lbs., 6 x 5 1/2 x 12
 ONE TIME OFFER! LIMIT TWO (2) SUPPLIES PER CUSTOMER.

- COD MINIMUM \$20.00 + ADD \$2.50 FOR COD'S
- UPS DELIVERY ADDRESS MUST ACCOMPANY ALL COD ORDERS
- \$1.00 HANDLING ON ORDERS UNDER \$10.00
- VISA, MC CARDS OR CHECK
- ADD 6% FOR SHIPPING
- TEXAS RESIDENTS ADD 5% STATE SALES TAX
- CALL FOREIGN ORDERS ADD 25% FOR SHIPPING (CANADA 15%) NO FOREIGN COD'S
- CALL (214) 276-3553 TO PLACE CREDIT CARD OR COD ORDER

NOTHING OVER \$89.00 1 YEAR WARRANTY

INSTRUMENTS COME WITH BATTERY AND TEST LEADS

\$88.95 MODEL 30B-230

DIGITAL CAPACITANCE METER

- Measurement ranges 0.1 pF to 1999 uF
- Accuracy 0.5% typical
- 3 1/2 digit 0.5" LCD display
- Immediate direct reading
- Fuse protected against accidental high voltage connection
- 200 hour battery life

SPECIFICATIONS: Ranges: 8 ranges with full scale values from 200pF to 2000uF. **Accuracy:** +/- 0.5% of full scale +/- 1 digit to 200uF range, +/- 1% of full scale +/- digit on 2000uF range. **Resolution:** 0.1 pF. **Sampling Time:** 0.5 sec. **Out-of-Range Indication:** Indication of '1'. **Time Base:** Crystal O.S.C.

\$54.95 MODEL 30B-150

DIGITAL DMM

- 0.5" LCD display
- DC input impedance 10M
- DC 100uV, 100mA, 0.1 ohm resolution
- DCA up to 10A
- Auto polarity
- Diode & hFE transistor tests
- Low battery indicator
- Overload protection

SPECIFICATIONS: Ranges: DCV: 200mV, 2, 20, 200, 1000V. ACV: 200, 1000V. DC CURRENT: 200u, 2m, 20m 200m, 10A. RESISTANCE: 2K, 20K, 200K, 2M ohm. **Accuracy:** DCV: +/- 0.5% (200mV), +/- 0.8% (2V up of full scale, ACV & DC CURRENT); +/- 1.2% of full scale

CV-20 1.80 ea.
 10 for \$14.00
 100 for \$114.00

Select your game or TV for instant viewing 300 ohm input, 300 ohm output.

CV-93 \$19.95 ea.

Provides remote control access of all your Video, TV or Cable inputs to your TV set or Big Screen TV from one convenient location by merely flipping a switch.

CV-19 \$2.60

Select your VCR/Cable TV or outdoor antenna signals. Two 75 ohm input; 300 ohm output. 6" leads.

CV-94 \$19.95

Converts mid & super band cable channels for viewing on your TV set!

36 CHANNEL CONVERTER

- Japanese TRS & ICS
- ECG Replacements
- Video Accessories
- Solder & Desoldering Tools
- Test Equipment
- Capacitors & Resistors
- And Many Others
- Call 415-532-2711 for free catalog

Matching Transformer
 0.70 each
 10 for \$5.90
 100 to \$44.00

NO MINIMUM Shipping \$3.00
 \$15 or under \$4.00
 Overseas order add \$5.00
 COD \$1.50 25% Deposit required
 M.O., VISA, M/C, COD, Company Check
 CAL. Residents add app. sales tax

EPS Box 5356, Berkeley CA 94705
 TOLL FREE: 800-227-0104
 In CALIF. CALL: 415-532-2711

“The Deluxe II”

Is The Ultimate In UHF Sine Wave
Converter Technology

PC BOARD & PLANS \$20.00

With purchase of COMPLETE SET OF PARTS & ENCLOSURE

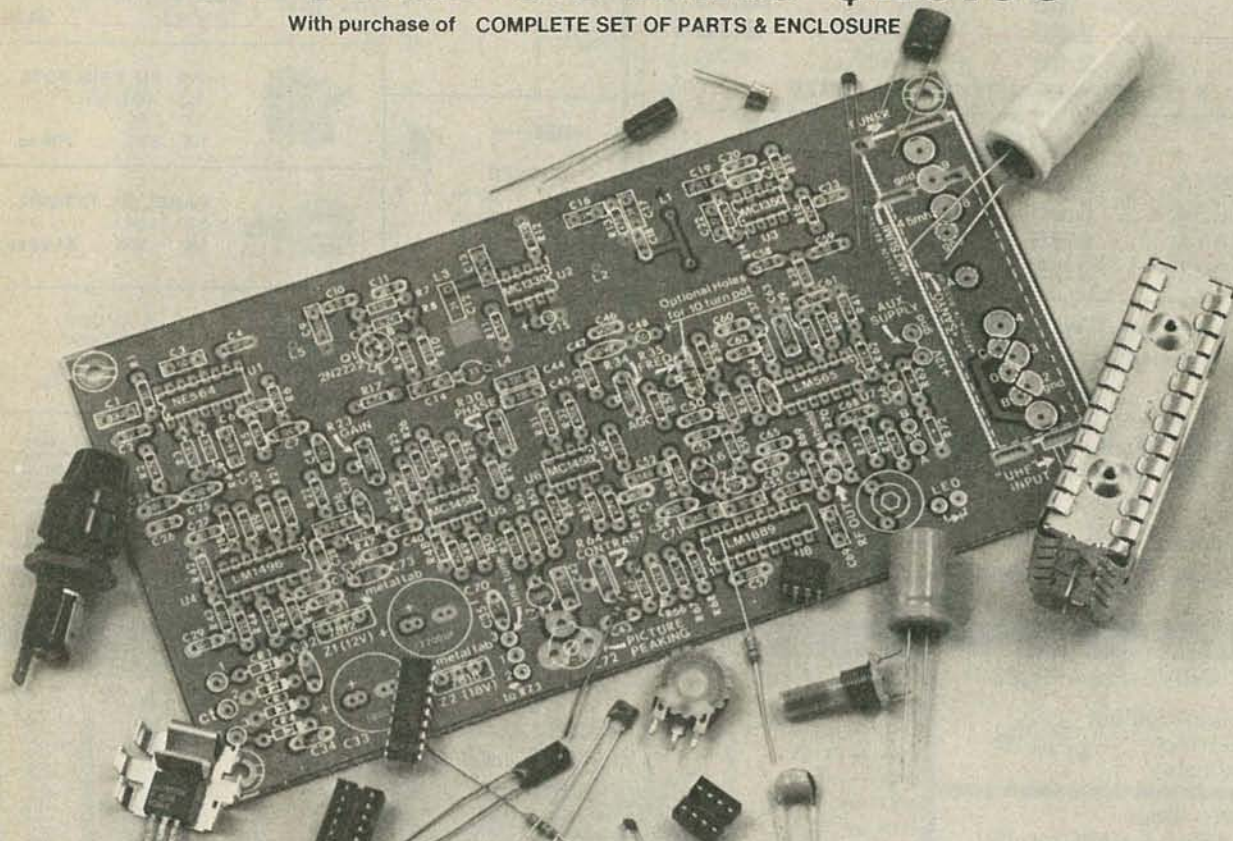

The latest state of the art electronics combined with the excellence in printed circuit manufacturing creates this high performance UHF Sine Wave Converter kit that outperforms the imitations by a long shot. Engineered for reliable stability and outstanding reception clarity, uninterrupted modulated audio and fully illustrated instructions with the amateur in mind.

BETA ELECTRONICS, 1700 E. DESERT INN ROAD, SUITE 222, LAS VEGAS, NEVADA, 89109

TOLL FREE
1-800-782-2701

| QTY | DESCRIPTION OF ITEM | COST EACH | SHIPPING EACH | TOTAL |
|-----|------------------------------------|-------------|---------------|-------|
| | PC BOARD, PLANS, PARTS & ENCLOSURE | \$152.99 | \$4.95 | |
| | PARTS & ENCLOSURE ONLY | \$132.99 | \$4.95 | |
| | PC BOARD & PLANS ONLY | \$30.00 | \$1.50 | |
| | | GRAND TOTAL | \$ | |

PLEASE
PRINT CLEARLY

SEND THIS
ORDER FORM

NAME _____

ADDRESS _____

CITY/STATE/ZIP _____

VISA MST. CARD CARD NO. _____

QUANTITY DISCOUNTS AVAILABLE

ORDER DATE _____

EXP. DATE _____

MO. DAY YR.

FOR IMMEDIATE DELIVERY MONEY ORDERS OR CERTIFIED CHECKS PREFERRED — PERSONAL CHECKS ALLOW 4 WEEKS FOR DELIVERY

TECHNICIANS REPAIRMEN • HOBBIEIST

WE CAN SUPPLY YOU ALL YOUR NEED FOR YOUR
MAINTENANCE, REPAIR WORK & DESIGN.

AMERICAN, JAPANESE, EUROPEAN TYPES
REPLACEMENT FOR ECG*

CHECK THIS! (Min. 5 pcs. each)

| ECG* Type No. | YOUR PRICE | ECG* Type No. | YOUR PRICE |
|------------------|---------------|------------------|---------------|
| 123A..... | .28 | 500A..... | 8.95 |
| 152..... | .60 | 523..... | 10.75 |
| 153..... | .65 | 526A..... | 10.95 |
| 165..... | 2.25 | HIDIV-1*..... | 3.75 |
| 238..... | 2.25 | HIDIV-3*..... | 3.75 |

3 YEARS WARRANTY ON EXR PARTS

SPECIAL (Min. 5 pcs. each)

| | | | |
|-------------|------|-------------|------|
| 2SC867A.... | 2.95 | AN214Q.... | 1.50 |
| 2SC1034.... | 5.95 | STK439.... | 7.25 |
| 2SC1114.... | 3.45 | UPC1181H... | 1.95 |
| 2SC1308K... | 2.25 | UPC1182H... | 1.95 |

Call Toll-Free 800-526-4928

COD ORDERS WELCOME (Min. order \$25)

CALL OR WRITE FOR OUR 1982 PRICE LIST

DIGITRON ELECTRONIC

110 Hillside Avenue, Springfield, N.J. 07081
201-379-9016, 379-9019

ECG IS A TRADE MARK OF PHILIPS ECG.
DIGITRON IS NOT ASSOCIATED IN ANY WAY WITH PHILIPS ECG.

CIRCLE 61 ON FREE INFORMATION CARD

POPULAR CHIPS

| | |
|---------|------|
| LM 301 | 1.00 |
| LM 380 | 1.25 |
| LM 386 | .79 |
| NE 564 | 2.50 |
| LM 565 | .89 |
| MC 1330 | 1.10 |
| MC 1350 | 1.00 |
| MC 1358 | 1.10 |
| MC 1458 | .49 |
| MC 1496 | 1.50 |
| LM 1889 | 1.85 |
| 7808 | .75 |
| 7812 | .75 |
| 7815 | .75 |
| 7818 | .75 |
| MV 2109 | .69 |
| 2N2222A | .30 |



MITSUMI
UES A55F
VARACTOR TUNER
CHAN. 14-83
300 ohm INPUT \$17.95



ASTEC MODULATOR
MINI VIDEO MODULATOR
FOR USE WITH
COMPUTER-VIDEO
GAMES.
WITH SPECS. \$8.95



GENERAL INST. UHF
TUNER MECHANICAL 12
VDC 14-83 DETENT
TUNING \$4.95



3/8" SQ. TRIM POTS
TOP ADJUST
1K 10K
5K 20K 79¢ ea.



PANEL MT. 10 TURN
500 10K
1K 20K \$5.95 ea.

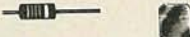

CHOKES
.33 uh 33 uh
.47 uh 100 uh
15 uh 10 mh
18 uh 69¢ each

VARI CAPS
10 - 60 pf 69¢ each
30 - 90 pf 69¢ each

UHF AMP KIT
25 db gain
\$9.95

ADJ. COIL
pri - .44 uh CT
sec - .33 uh
3/16" form 99¢

NETWORK SALES, INC.

2343 W. BELMONT AVE.
CHICAGO, IL. 60618
312-248-3202

TERMS: Visa, M.C., Check,
Money Order or COD (add
3.00). Min. Order \$10.00. Add
\$2.50 S&H for USA Ill. add 7%
Tax. Mail Order Only. Phone
Orders Welcome.

WRITE FOR OUR MONTHLY
UN-ADVERTISED SPECIALS

CIRCLE 69 ON FREE INFORMATION CARD

DISK DRIVE For APPLE!!

- metal cabinet ☆☆☆
- 35 track \$279.95
- w/cable

Computer Games: APPLE & ATARI (specify)

- Choplifter → \$24.95ea.
- Frogger → \$24.95ea.
- Apple Panic → \$21.95ea.
- Crossfire → \$21.95ea.
- Raster Blaster → \$21.95ea.

SUPER 3.5amp POWER SUPPLY for APPLE → \$105.00 ☆

Diskette Storage BOX

5 1/4 in. > 5" : 8 in. > 5"
\$2.50ea. \$10.00: \$3.50 \$15.00

Bare Bones APPLE II EURO

w/o Keyboard = 48K RAM =
\$399.
w/o Pwr. Supply

Microswitch: \$75.00
Power Supply: \$95.00
Apple Reference Manl.: \$18.00

SPECIALS

- 3inch Mini FAN → \$8.95
- 2111 → \$2.45
- 8155 → \$1.50
- ER2501 → \$4.95
- AY5 1013A → \$2.95
- 8202 → \$29.95
- 6522 → \$5.25
- 8255 → \$4.50
- 8748-B → \$31.00
- MC6800 → \$7.75
- MC6802 → \$14.95
- MC6850 → \$4.50
- MC6821 → \$4.95
- 6331 → \$1.25

- 4116-2 → 8/9.95
- 2716(5v) → 3.25ea
- 2732(5v) → 5.25ea
- 2532(5v) → 8.75ea
- Z80 A CPU → 5.25ea
- 1982 I.C. (2vol.) Master \$49.95

Diskette SALE!!

call for Qty. Price "Wabash"

| | | |
|------------|-------|-------|
| SS/SD soft | 5 1/4 | 8inch |
| SS/SD | 18.50 | 21.50 |
| DS/SD | 27.40 | 30.40 |
| DS/SD | 0 | 34.90 |
| DS/DD | 32.40 | 37.40 |

CONCORD COMPUTER PRODUCTS

2910 B E LA PALMA
ANAHEIM CA 92806
(714) 632-6790 CHECK - M O
NO C O D
10 MIN ORDER. CA RES ADD 6% ALIEN MKS DEL. 11%
FREIGHT. PRISMA. CHECK S STRT

MONITORS ☆☆☆ ZENITH # ZVM-121

12in. 15MHz./GREEN Phos.
→ \$102.00 ☆

BMC # BM-120SU 12in. 18MHz./GREEN Phos. Non-Glare Screen

→ \$128.00 ☆
BMC # BM1401RGB
13in. "RGB" COLOR
with Apple interface!!
→ \$425.00 ☆

REAL-TIME CLOCK CALENDAR (MSM 5832)

\$6.25 / \$1.25 xtal.
Syntron II
Computer
★ 48K RAM
★ Runs Apple Software
\$649.00

COMPONENTS

| 7400 SERIES | | | 74S SERIES | | |
|-------------|----|------|------------|-------|-----|
| 7400 | 18 | 7454 | 19 | 74500 | 35 |
| 7402 | 18 | 7470 | 30 | 74502 | 38 |
| 7404 | 18 | 7472 | 45 | 74504 | 45 |
| 7406 | 18 | 7474 | 45 | 74506 | 45 |
| 7408 | 18 | 7476 | 40 | 74508 | 40 |
| 7410 | 18 | 7478 | 30 | 74510 | 55 |
| 7412 | 18 | 7480 | 100 | 74512 | 55 |
| 7414 | 18 | 7482 | 35 | 74514 | 75 |
| 7416 | 18 | 7484 | 35 | 74516 | 35 |
| 7418 | 18 | 7486 | 60 | 74518 | 25 |
| 7420 | 18 | 7488 | 60 | 74520 | 60 |
| 7422 | 18 | 7490 | 90 | 74522 | 75 |
| 7424 | 18 | 7492 | 40 | 74524 | 95 |
| 7426 | 18 | 7494 | 40 | 74526 | 95 |
| 7428 | 18 | 7496 | 40 | 74528 | 95 |
| 7430 | 18 | 7498 | 40 | 74530 | 95 |
| 7432 | 18 | 7500 | 200 | 74532 | 110 |
| 7434 | 18 | 7502 | 200 | 74534 | 110 |
| 7436 | 18 | 7504 | 200 | 74536 | 110 |
| 7438 | 18 | 7506 | 100 | 74538 | 110 |
| 7440 | 18 | 7508 | 100 | 74540 | 125 |
| 7442 | 18 | 7510 | 100 | 74542 | 125 |
| 7444 | 18 | 7512 | 100 | 74544 | 125 |
| 7446 | 18 | 7514 | 100 | 74546 | 125 |
| 7448 | 18 | 7516 | 100 | 74548 | 125 |
| 7450 | 18 | 7518 | 100 | 74550 | 125 |
| 7452 | 18 | 7520 | 100 | 74552 | 125 |
| 7454 | 18 | 7522 | 100 | 74554 | 125 |
| 7456 | 18 | 7524 | 100 | 74556 | 125 |
| 7458 | 18 | 7526 | 100 | 74558 | 125 |
| 7460 | 18 | 7528 | 100 | 74560 | 125 |
| 7462 | 18 | 7530 | 100 | 74562 | 125 |
| 7464 | 18 | 7532 | 100 | 74564 | 125 |
| 7466 | 18 | 7534 | 100 | 74566 | 125 |
| 7468 | 18 | 7536 | 100 | 74568 | 125 |
| 7470 | 18 | 7538 | 100 | 74570 | 125 |
| 7472 | 18 | 7540 | 100 | 74572 | 125 |
| 7474 | 18 | 7542 | 100 | 74574 | 125 |
| 7476 | 18 | 7544 | 100 | 74576 | 125 |
| 7478 | 18 | 7546 | 100 | 74578 | 125 |
| 7480 | 18 | 7548 | 100 | 74580 | 125 |
| 7482 | 18 | 7550 | 100 | 74582 | 125 |
| 7484 | 18 | 7552 | 100 | 74584 | 125 |
| 7486 | 18 | 7554 | 100 | 74586 | 125 |
| 7488 | 18 | 7556 | 100 | 74588 | 125 |
| 7490 | 18 | 7558 | 100 | 74590 | 125 |
| 7492 | 18 | 7560 | 100 | 74592 | 125 |
| 7494 | 18 | 7562 | 100 | 74594 | 125 |
| 7496 | 18 | 7564 | 100 | 74596 | 125 |
| 7498 | 18 | 7566 | 100 | 74598 | 125 |
| 7500 | 18 | 7568 | 100 | 74600 | 125 |
| 7502 | 18 | 7570 | 100 | 74602 | 125 |
| 7504 | 18 | 7572 | 100 | 74604 | 125 |
| 7506 | 18 | 7574 | 100 | 74606 | 125 |
| 7508 | 18 | 7576 | 100 | 74608 | 125 |
| 7510 | 18 | 7578 | 100 | 74610 | 125 |
| 7512 | 18 | 7580 | 100 | 74612 | 125 |
| 7514 | 18 | 7582 | 100 | 74614 | 125 |
| 7516 | 18 | 7584 | 100 | 74616 | 125 |
| 7518 | 18 | 7586 | 100 | 74618 | 125 |
| 7520 | 18 | 7588 | 100 | 74620 | 125 |
| 7522 | 18 | 7590 | 100 | 74622 | 125 |
| 7524 | 18 | 7592 | 100 | 74624 | 125 |
| 7526 | 18 | 7594 | 100 | 74626 | 125 |
| 7528 | 18 | 7596 | 100 | 74628 | 125 |
| 7530 | 18 | 7598 | 100 | 74630 | 125 |
| 7532 | 18 | 7600 | 100 | 74632 | 125 |
| 7534 | 18 | 7602 | 100 | 74634 | 125 |
| 7536 | 18 | 7604 | 100 | 74636 | 125 |
| 7538 | 18 | 7606 | 100 | 74638 | 125 |
| 7540 | 18 | 7608 | 100 | 74640 | 125 |
| 7542 | 18 | 7610 | 100 | 74642 | 125 |
| 7544 | 18 | 7612 | 100 | 74644 | 125 |
| 7546 | 18 | 7614 | 100 | 74646 | 125 |
| 7548 | 18 | 7616 | 100 | 74648 | 125 |
| 7550 | 18 | 7618 | 100 | 74650 | 125 |
| 7552 | 18 | 7620 | 100 | 74652 | 125 |
| 7554 | 18 | 7622 | 100 | 74654 | 125 |
| 7556 | 18 | 7624 | 100 | 74656 | 125 |
| 7558 | 18 | 7626 | 100 | 74658 | 125 |
| 7560 | 18 | 7628 | 100 | 74660 | 125 |
| 7562 | 18 | 7630 | 100 | 74662 | 125 |
| 7564 | 18 | 7632 | 100 | 74664 | 125 |
| 7566 | 18 | 7634 | 100 | 74666 | 125 |
| 7568 | 18 | 7636 | 100 | 74668 | 125 |
| 7570 | 18 | 7638 | 100 | 74670 | 125 |
| 7572 | 18 | 7640 | 100 | 74672 | 125 |
| 7574 | 18 | 7642 | 100 | 74674 | 125 |
| 7576 | 18 | 7644 | 100 | 74676 | 125 |
| 7578 | 18 | 7646 | 100 | 74678 | 125 |
| 7580 | 18 | 7648 | 100 | 74680 | 125 |
| 7582 | 18 | 7650 | 100 | 74682 | 125 |
| 7584 | 18 | 7652 | 100 | 74684 | 125 |
| 7586 | 18 | 7654 | 100 | 74686 | 125 |
| 7588 | 18 | 7656 | 100 | 74688 | 125 |
| 7590 | 18 | 7658 | 100 | 74690 | 125 |
| 7592 | 18 | 7660 | 100 | 74692 | 125 |
| 7594 | 18 | 7662 | 100 | 74694 | 125 |
| 7596 | 18 | 7664 | 100 | 74696 | 125 |
| 7598 | 18 | 7666 | 100 | 74698 | 125 |
| 7600 | 18 | 7668 | 100 | 74700 | 125 |
| 7602 | 18 | 7670 | 100 | 74702 | 125 |
| 7604 | 18 | 7672 | 100 | 74704 | 125 |
| 7606 | 18 | 7674 | 100 | 74706 | 125 |
| 7608 | 18 | 7676 | 100 | 74708 | 125 |
| 7610 | 18 | 7678 | 100 | 74710 | 125 |
| 7612 | 18 | 7680 | 100 | 74712 | 125 |
| 7614 | 18 | 7682 | 100 | 74714 | 125 |
| 7616 | 18 | 7684 | 100 | 74716 | 125 |
| 7618 | 18 | 7686 | 100 | 74718 | 125 |
| 7620 | 18 | 7688 | 100 | 74720 | 125 |
| 7622 | 18 | 7690 | 100 | 74722 | 125 |
| 7624 | 18 | 7692 | 100 | 74724 | 125 |
| 7626 | 18 | 7694 | 100 | 74726 | 125 |
| 7628 | 18 | 7696 | 100 | 74728 | 125 |
| 7630 | 18 | 7698 | 100 | 74730 | 125 |
| 7632 | 18 | 7700 | 100 | 74732 | 125 |
| 7634 | 18 | 7702 | 100 | 74734 | 125 |
| 7636 | 18 | 7704 | 100 | 74736 | 125 |
| 7638 | 18 | 7706 | 100 | 74738 | 125 |
| 7640 | 18 | 7708 | 100 | 74740 | 125 |
| 7642 | 18 | 771 | | | |

DISK DRIVE FOR YOUR APPLE



QUIETER THAN SHUGGART DRIVES!

Enclosed in a handsome metal enclosure, color matched to your Apple. Connects to your Apple Disk Interface Card or to our own Apple Compatible Disk Drive Card. 90 day warranty. Includes cable. If not satisfied return within 30 days for full refund.

Disk Drive \$274.99
Controller Card \$ 89.95

16K Apple Ram Card Kit

- Upgrade your 48K Apple to full 64K Ram.
- Hardware/Software compatible with Apple language card and Z80 card.
- Run Apple Fortran or Pascal

Kit \$39.95
Bare Card \$13.95

R.F. Modulator

Combine both audio and video output onto channel 3 or 4 of your T.V. set. Single I.C. chip (MC 1374) makes for quick and easy assembly. Single adjustment control! A must for every video recording or computer enthusiast.

VH-0 Kit \$19.95

UHF T.V. Preamp

- Features:
- 25 dB gain!
 - Kit

Your reception will dramatically improve! This unit will enable you to pull in signals you never knew were there!

For both indoor and outdoor use. Input and output impedance 75 ohm. No adjustment! Easy assembly.

JH-0 Kit \$22.95

Tired of getting up to change channels? Get rid of that mechanical cable controller. Relax with ... PHILIPS CTC8R Remote Cable Converter



- Micro computer technology
- Quartz controlled IC's lock in picture & prevent drift
- 60 channel selections
- Programmable time on and off
- Favorite channel memory and recall, plus scan
- Wireless hand held "infra-red" transmitter system (25 ft.)
- Automatic fine tune
- Adaptable to any brand television
- One year warranty service

CTC8R \$139.95
CTC9R (with 24 hr. LED digital clock) \$149.95

SATELLITE TV KIT!!!

It's not ready yet, but we guarantee it will be revolutionary in size and price. Send or inquire for preliminary information. **Priced below \$350.00.** Available in April.

LSS-1 less than \$350.00

DIGITAL MULTIMETER MIC-6000Z



- 3½ Digits
- DC 0.5% Accuracy
- DCA and ACA up to 10A
- OHM up to 20 M OHM
- Audible Continuity Test
- Diode Check
- Leads and Battery Included



AUDIBLE

The MIC-6000Z is a professional Multimeter at an inexpensive price.

The 6000Z works up to 1000 hours on a common battery, also can withstand 1000 VDC loads. Resistance ranges are protected up to 400 VDC. For your added convenience the MIC-6000Z has a built-in 10 amp current capacity, so you don't need an accessory shunt.

MIC-6000Z Assembled \$89.95
Carrying Case \$ 9.95

ADJUSTABLE DUAL POWER SUPPLY KIT



- Adjustable Positive & Negative Supplies
- Positive and negative 1.2 VDC to 15 VDC
- Power Output (Each Supply) 5 VDC @ 500 ma, 10 VDC @ 750 ma, 12 VDC @ 750 ma, 15 VDC @ 175 ma
- Two 3 Terminal Adjustable Regulators with Overload Protection • LED on indicator
- P.C. Board Construction • 120 VAC Input

RM1 Kit \$24.95

MORE GAIN Than a

MODEL ELC 1045 **Mitsumi Tuner**
FREQ. RANGE UHF 470-889 MHz
CHANNEL 14-83
OUTPUT CHANNEL 3
75 OHM INPUT

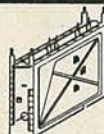

Comes with adapter board. You can plug Philips Tuner directly in place of a Mitsumi

| Part No. | Description | Price |
|----------|----------------------------|---------|
| PWD10 | Philips UHF Tuner ELC 1045 | \$23.95 |

MICROWAVE RECEIVER SYSTEM

- Commercial grade reception — 1.9-2.5 GHz
 - Sturdy Parabolic aluminum reflector antenna
 - High gain 50 db!
 - Line of sight distance 45 miles!
 - Downconverter located in your house not outdoors in the antenna.
 - Complete system, power supply, cable, assembled reflector antenna, and downconverter.
 - Downconverter mounted in attractive cabinet.
- PS-5 Assembled \$129.95
Kit Form \$ 99.95

MICROWAVE PREAMP

For your Parabolic Dish Antenna

- Improve your picture quality
- Increase your reception distance
- 15 db gain, 2 db noise factor!
- Easy assembly
- 1.9 GHz to 2.5 GHz
- Mounts indoors or outdoors
- Can be used with PS-5!

DSC-1 KIT \$39.95



Digital Multimeter MIC-3300A

- Kit Form • 3½ Digits
- DC .5% Accuracy
- DCA up to 10 Amps • OHM up to 20 M OHM
- hFE measurement • Floating decimal point
- Leads + battery included • Easy instructions

A high quality Digital Meter Kit at an affordable price. Educational and enjoyable to build, the MIC 3300A is a high quality meter for all hobbyists and maintenance work.

MIC-3300A Kit Form \$59.95
Carrying Case \$ 9.95

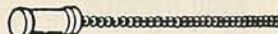

Microwave Receiver 1.9-2.5 GHZ

- PS-1 Assembled 32 element antenna ... \$19.95
PS-2 20 dB gain microwave receiver kit with variable power supply kit \$50.00
PS-3 Complete package PS-1 & PS-2 ... \$65.00
- Mounting Hardware Included

Microwave Preamp!!!

Use with PS-3 Kit. Adds 20-25 db gain to boost reception distance.

- Low Noise
- High Gain
- Can be used with all existing stop sign board receivers!!!!
- 1.9-2.5 GHz Freq. Range

PS-4 \$34.95

SEI, Inc.

912 W. Touhy, Park Ridge, IL 60068

Illinois Residents
(312) 564-0104
Orders Only, Toll Free #
(800) 323-1327

Minimum order \$15.00. Add 10% shipping on orders under \$35.00. Orders over \$35.00, add 5%. Illinois residents add 6% Sales Tax. **Catalog — \$1.00**



VISA and MasterCard Acceptable



MP SYSTEMS
MP SYSTEMS
MP SYSTEMS
MP SYSTEMS

Fast, Reliable Service is Our Specialty.

MP SYSTEMS

WILL IMPROVE

YOUR MEMORY . . .

| | |
|--|--|
| 16K EXPANSION KIT 8 pcs 4116 200 ns | 64K EXPANSION KIT 9 pcs 4164 200 ns |
| \$11.95 | \$74.25 |

AND DRIVE YOU

| | |
|---|----------|
| IMI 5" Industry Standard 5 1/4" Winchester Disk Drive | |
| 6 mB | \$865.00 |
| Siemens™ 8" Floppy Disk Drive | |
| FDD 100-8 | \$300.00 |

FRANKLIN ACE 1000

\$1350.00

APPLE CLOCKCHIP

| | |
|-----------|----------|
| MM58167AN | \$ 15.00 |
|-----------|----------|

EPROMS

| | | | |
|------|------|------|-------|
| 2708 | 5.65 | 2716 | 5.50 |
| 2732 | 9.00 | 2532 | 12.00 |

DB CONNECTOR

| | |
|----------------|--------|
| DB25P (RS232) | \$2.95 |
| DB25S (Female) | 4.25 |
| Hood | 1.80 |
| DB9P | 2.50 |
| DB9S | 3.37 |
| Cover | 1.10 |
| DB15P | 3.77 |
| DB15S | 4.21 |
| Cover | 1.25 |

6500 FAMILY

| | |
|--------|---------|
| R6502P | \$ 6.95 |
| R6511P | 34.55 |
| R6520P | 4.00 |
| R6522P | 6.20 |
| R6532P | 8.55 |
| R6545P | 17.65 |
| R6551P | 8.75 |

LPS II™

High resolution, high speed light pen for Apple II™ computers. Compatible with Franklin Ace 1000

\$349.00

ASK FOR FREE FLYER
ASK FOR QUANTITY PRICING

\$100.00 minimum order.
 Terms C.O.D. Prepaid or credit to rated firms.
 F.O.B.: Laguna Hills, CA.
 Shipping charges will be added.
 All pricing subject to change without notice.
 Call for quantity pricing.
 Bank cards accepted: MasterCard, Visa



MP SYSTEMS
 23341 DEL LAGO
 LAGUNA HILLS, CA 92653
 (714) 770-6411

CIRCLE 56 ON FREE INFORMATION CARD

Fujitech
Model M-64 Programmer

- Very Easy to Operate
- Various test, check and protection functions for correct programming
- Programs 10 pieces of the following at one time:
 2716
 2732
 2732A
 2764



(models for other types of EPROM's also available)

- Lowest price in the industry: \$999.00
- Write for brochure

MONARCHY ENGINEERING INC.

380 Swift Ave. #21

So. San Francisco, CA 94080

KNAPCO

G.E. MOV Spike Eliminators V130-LA-10A
 10/*9.90 \$1.29
 115V

Cabinet
 Black Metal
 2 1/2" X 4" X 2" High
 100/*85.00 **99¢**

Chassis (H.D.) Fantastic!
 4" X 8" X 2 1/4" H.
 100/*65.00 **79¢**

115 V. BLOCK FANS
 3" SQ.
 # FAN 31 **\$6.95**

ULTRASONIC BUG ELIMINATOR
 IC BASE CIRCUITRY WITH PIEZO
 ALL COMPONENTS —
 ELIMINATE COCKROACHES,
 FLEAS, BUGS. **KIT \$14.95**

2 1/2" Meters Choice Of Any 1
 0-25 VDC
 0-15 DCA
 30-0-30 DCA **\$5.95**
 10/*50.00

Tri-Color LEDs
 Red/Green reverse volt.
 Yellow A.C. **2/*1.50**

Transformer **\$2.39**
 30V. CT. 1.5 AMP.
 10/*22.00 100/*200.00

TRANSFORMERS
 MULTI-TAPS
 TR 79 6, 7, 9, 12 @ 1 to 1.7 A., 10V./8 A.
 + 46 V./2.5 A. C.T. **\$6.95**
 TR 97 6.5V./4 A., 16V./5 A.,
 30V./3A., 17V./30A. C.T. **\$23.95**

'LIGHT GUARD'
 auto light off unit
 adjustable timer
 2/12v. 10a. relay circuits
 sears sold \$39.95 **\$5.95**

Voltage Regulators
 +5V. 7805
 -5V. 79M05
 +6V. 7806
 +12V. 7812
5/*5.50 10/*9.95 + 15V. 7815

MOTOROLA PIEZO SPEAKERS
 3/4" RESPONSE
 60 TO 30,000 Hz **10/*55.00**

Milton-Bradley COMPUTER PERFECTION
 new boards w/ microprocessor
10/*6.95 99¢

Dual Computer Chip Set
 2 CPU & MPU Systems/Dual -
 Clocks, ACPU,
 512 X 8 Bi Polar Ram 50 usec.
 & support
 R 29623 Bi Polar Ram
 74LS624 Volt Cont. Osc.
 74121 (2) 7413 (2)
 29701 64 X 8 Prom
 MC 8601 Monostable, Retrigr.
 Multivibrator (2)
 CA 3246 Quad 20 MA. OP AMP.
 6503 CPU
 8048 MPU **\$9.95**
 723 Reg.
 TMS 9901Prog. Keyboard Interface

ITT Power Supply
 Triple or Dual
 ± 2% Low Ripple
 Choice Of
 +12V. 7A -12V 7A
 or 24V. 7A.
 And 5V. 10A.
 \$300.00 Orig. Teletype Cost
 5" X 5" High X 14" **\$59.95**

Power Inverter
 12V. to 115V.
 450 Watt **\$79.95**
 Full Warranty Reg. OEM \$139.95

Voltage Regulator Boards
 Just hook up to transformer
 Choice Of:
 12V., 9V., 6V. @ 1.5A. **\$1.29**
ADJUSTABLE BOARDS
 4.5V. to 18V.DC **\$1.95**

RFI FILTERS
 2 AMP. HOPKINS
 # F-85010 **\$1.99**

Dip Tantalum Caps
 6.8, 10, 15, 22, 33, 47, @ 6.3V.
 22, 68 @ 10V.
 1.5, 3.3, 4.7, 6.8 @ 16V.
 15 @ 20V.
 .47, .68, 1.5, 2.2, 3.3, 4.7, 6.8 @ 35V.
 .22, .68, 1 @ 50V. dipped and solid **29¢**

Piezo Elements
 Fantastic **39¢**
 Murata Transducer

PLASTIC CASES
79¢
 100 pcs. \$75.
 1000 \$650.

3" X 4" X 2" High

Specialty Chips
 IM6402 Uarts \$4.95
 MC10125P Bus Driver \$3.50
 MM1400ML CPU \$.59
 4164-15NL '85.50 RAM 64K
 MM1702 '85.95 Eprom
 4116 200NS, 8/115.50 Ram
 8080A CPU 1.95

SEND FOR FREE 1983 CATALOG
 or call us at
 (813) 392-0406

H.J. Knapp of Florida, Inc.
 4750 96th St. N. St. Petersburg, Florida 33708

CIRCLE 81 ON FREE INFORMATION CARD

RADIO-ELECTRONICS

Do Kay Computer Products, Inc.

VISIT OUR RETAIL STORE
AND RECEIVE A 5% DISCOUNT!

3250 KELLER STREET, #9 • SANTA CLARA, CA 95050

| 8000 | | | |
|------|-------|--------|-------|
| 135 | 6.95 | 8239 | 4.75 |
| 139 | 7.59 | 8243 | 4.75 |
| 180A | 3.90 | 8250 | 14.90 |
| 185A | 7.95 | 8251 | 4.50 |
| 188 | 34.95 | 8253 | 8.75 |
| 55 | 7.75 | 8253-5 | 9.75 |
| 56 | 7.75 | 8255 | 4.50 |
| 85 | 29.00 | 8255-5 | 5.20 |
| 741 | 39.00 | 8257 | 8.50 |
| 748 | 14.95 | 8259 | 6.85 |
| 755 | 29.95 | 8272 | 39.00 |
| 202 | 27.95 | 8275 | 29.00 |
| 205 | 3.45 | 8279 | 9.25 |
| 212 | 1.80 | 8279-5 | 9.95 |
| 214 | 3.75 | 8282 | 6.50 |
| 216 | 1.75 | 8283 | 6.50 |
| 224 | 2.45 | 8284 | 5.50 |
| 226 | 1.80 | 8286 | 6.50 |
| 228 | 4.50 | 8287 | 6.50 |
| 237 | 19.00 | 8288 | 25.00 |
| 238 | 4.75 | 8289 | 49.00 |

16K APPLE RAM CARD
Upgrade your 48K Apple II to full 64K

BARE BOARD 14.00
KIT 39.90
ASSEMBLED & TESTED 45.00

LEDS

| | |
|--------------|---------|
| Jumbo Red | 10/1.00 |
| Jumbo Green | 6/1.00 |
| Jumbo Yellow | 6/1.00 |

CONNECTORS

| | |
|---------------|------|
| RS 232 Male | 3.00 |
| RS 232 Female | 3.50 |
| RS 232 Hood | 1.20 |

6500

| | |
|-------|-------|
| 6502 | 5.49 |
| 6502A | 9.45 |
| 6504 | 6.90 |
| 6505 | 7.65 |
| 6507 | 9.90 |
| 6520 | 4.35 |
| 6522 | 7.95 |
| 6532 | 9.95 |
| 6551 | 11.75 |

Z80

| | |
|-----------|------|
| Z80 A CPU | 4.95 |
| Z80 A PIO | 4.95 |
| Z80 A CTC | 6.95 |

MICROPROCESSOR REAL-TIME CLOCK
MSM 5832
6.90

UPGRADE YOUR APPLE or TRS-80
4116 200ns
8/10.00

WE WILL BEAT ANY COMPETITOR'S PRICES!
Call before you buy

CRYSTALS

| | | | |
|------------|------|----------|------|
| 32.768 KHZ | 1.90 | 5.185 | 3.90 |
| 1.0 MHZ | 4.50 | 5.7143 | 3.90 |
| 1.8432 | 4.50 | 6.5536 | 3.90 |
| 2.0 | 3.90 | 8.0 | 3.00 |
| 2.097152 | 3.90 | 10.0 | 3.00 |
| 2.4576 | 3.90 | 14.31818 | 3.90 |
| 3.2768 | 3.90 | 18.0 | 3.00 |
| 3.579545 | 3.00 | 18.432 | 3.00 |
| 4.0 | 3.00 | 20.0 | 3.00 |
| 5.0 | 3.00 | 22.1184 | 3.00 |
| 5.0688 | 3.90 | 32.0 | 3.90 |

74LS00 SERIES

| | | | | | |
|---------|------|---------|------|---------|------|
| 74LS00 | .24 | 74LS123 | .95 | 74LS253 | .80 |
| 74LS01 | .24 | 74LS124 | 2.90 | 74LS257 | .80 |
| 74LS02 | .24 | 74LS125 | .95 | 74LS258 | .80 |
| 74LS03 | .24 | 74LS126 | .79 | 74LS259 | 2.80 |
| 74LS04 | .24 | 74LS132 | .75 | 74LS260 | .60 |
| 74LS05 | .24 | 74LS136 | .49 | 74LS266 | .49 |
| 74LS08 | .24 | 74LS137 | .95 | 74LS273 | 1.60 |
| 74LS10 | .24 | 74LS138 | .75 | 74LS275 | 3.25 |
| 74LS11 | .30 | 74LS139 | .75 | 74LS279 | .49 |
| 74LS12 | .30 | 74LS145 | 1.10 | 74LS280 | 1.95 |
| 74LS13 | .40 | 74LS147 | 2.20 | 74LS283 | .95 |
| 74LS14 | .89 | 74LS148 | 1.20 | 74LS290 | 1.20 |
| 74LS15 | .30 | 74LS151 | .75 | 74LS293 | 1.79 |
| 74LS20 | .24 | 74LS153 | .75 | 74LS295 | .99 |
| 74LS21 | .30 | 74LS154 | 1.75 | 74LS298 | .99 |
| 74LS22 | .24 | 74LS155 | .89 | 74LS324 | 1.75 |
| 74LS26 | .30 | 74LS156 | .89 | 74LS352 | 1.49 |
| 74LS27 | .24 | 74LS157 | .75 | 74LS353 | 1.49 |
| 74LS28 | .30 | 74LS158 | .75 | 74LS363 | 1.49 |
| 74LS30 | .24 | 74LS160 | .95 | 74LS364 | 1.95 |
| 74LS32 | .36 | 74LS161 | .95 | 74LS365 | .89 |
| 74LS33 | .55 | 74LS162 | .95 | 74LS366 | .89 |
| 74LS37 | .55 | 74LS163 | .95 | 74LS367 | .69 |
| 74LS38 | .35 | 74LS164 | .95 | 74LS368 | .69 |
| 74LS40 | .30 | 74LS165 | .95 | 74LS373 | .99 |
| 74LS42 | .49 | 74LS166 | 1.95 | 74LS374 | 1.69 |
| 74LS47 | .75 | 74LS168 | 1.69 | 74LS377 | 1.40 |
| 74LS48 | .75 | 74LS169 | 1.69 | 74LS378 | 1.15 |
| 74LS49 | .75 | 74LS170 | 1.69 | 74LS379 | 1.35 |
| 74LS51 | .30 | 74LS173 | .75 | 74LS385 | 1.89 |
| 74LS54 | .35 | 74LS174 | .89 | 74LS386 | .59 |
| 74LS55 | .35 | 74LS175 | .89 | 74LS390 | 1.79 |
| 74LS63 | 1.20 | 74LS181 | 1.99 | 74LS393 | 1.79 |
| 74LS73 | .39 | 74LS189 | 9.50 | 74LS395 | 1.59 |
| 74LS74 | .44 | 74LS190 | .89 | 74LS399 | 1.59 |
| 74LS75 | .49 | 74LS191 | .89 | 74LS424 | 2.89 |
| 74LS76 | .39 | 74LS192 | .89 | 74LS447 | .75 |
| 74LS78 | .49 | 74LS193 | .89 | 74LS490 | 1.89 |
| 74LS83 | .75 | 74LS194 | .89 | 74LS668 | 1.65 |
| 74LS85 | .95 | 74LS195 | .89 | 74LS669 | 1.85 |
| 74LS86 | .39 | 74LS196 | .79 | 74LS670 | 2.10 |
| 74LS90 | .65 | 74LS197 | .79 | 74LS674 | 9.50 |
| 74LS91 | .79 | 74LS221 | 1.10 | 74LS682 | 2.99 |
| 74LS92 | .65 | 74LS240 | .95 | 74LS683 | 2.39 |
| 74LS93 | .59 | 74LS241 | .95 | 74LS684 | 2.39 |
| 74LS95 | .79 | 74LS242 | 1.79 | 74LS685 | 2.39 |
| 74LS96 | .79 | 74LS243 | 1.79 | 74LS688 | 2.39 |
| 74LS107 | .39 | 74LS244 | .95 | 74LS689 | 2.39 |
| 74LS109 | .39 | 74LS245 | 1.89 | | |
| 74LS112 | .39 | 74LS247 | .79 | 81LS95 | 1.65 |
| 74LS113 | .39 | 74LS248 | 1.20 | 81LS96 | 1.65 |
| 74LS114 | .49 | 74LS249 | .89 | 81LS97 | 1.65 |
| 74LS122 | .45 | 74LS251 | 1.25 | 81LS98 | 1.65 |

Disc Controller

| | |
|------|-------|
| 1771 | 16.00 |
| 1791 | 27.95 |
| 1793 | 29.95 |
| 1795 | 49.95 |
| 1797 | 49.95 |

Interface

| | |
|--------|------|
| 8T26 | 1.65 |
| 8T28 | 1.95 |
| 8T95 | .95 |
| 8T96 | .95 |
| 8T97 | .95 |
| 8T98 | .95 |
| DM8131 | 2.90 |
| DS8836 | 1.25 |

IC Sockets ST W/W

| | | |
|--------|-----|------|
| 8 PIN | .10 | .49 |
| 14 PIN | .12 | .50 |
| 16 PIN | .15 | .57 |
| 18 PIN | .20 | .85 |
| 20 PIN | .25 | .99 |
| 22 PIN | .25 | 1.30 |
| 24 PIN | .25 | 1.40 |
| 28 PIN | .35 | 1.50 |
| 40 PIN | .40 | 1.80 |

ST = Soldertail
W/W = Wirewrap

LINEAR

| | | | |
|--------|------|--------|------|
| LM301 | .32 | LM741 | .29 |
| LM308 | .75 | LM747 | .75 |
| LM309K | 1.25 | LM748 | .49 |
| LM311 | .64 | LM1310 | 2.45 |
| LM317T | 1.65 | MC1330 | 1.69 |
| LM317K | 1.70 | MC1350 | 1.25 |
| LM318 | 1.49 | MC1358 | 1.69 |
| LM323K | 3.75 | LM1414 | 1.49 |
| LM324 | .59 | LM1458 | .55 |
| LM337K | 3.90 | LM1488 | .95 |
| LM339 | .79 | LM1489 | .95 |
| LM377 | 2.25 | LM1800 | 2.45 |
| LM380 | 1.25 | LM1889 | 2.45 |
| LM386 | 1.00 | LM3900 | .59 |
| LM555 | .38 | LM3909 | .95 |
| LM556 | .65 | LM3914 | 3.70 |
| LM565 | .95 | LM3915 | 3.70 |
| LM566 | 1.45 | LM3916 | 3.70 |
| LM567 | .99 | 75451 | .35 |
| LM723 | .49 | 75452 | .35 |
| LM733 | .95 | 75453 | .35 |

ORDER TOLL FREE
(800) 538-8800
(800) 848-8008
(CALIFORNIA RESIDENTS)
ALL MERCHANDISE IS 100% GUARANTEED

CMOS

| | | | | | |
|------|-----|------|------|-------|------|
| 4000 | .25 | 4017 | 1.15 | 4082 | .30 |
| 4001 | .30 | 4018 | .90 | 4085 | .90 |
| 4002 | .30 | 4019 | .45 | 4086 | .90 |
| 4006 | .90 | 4020 | .90 | 4093 | .90 |
| 4007 | .25 | 4021 | .90 | 4098 | 2.49 |
| 4008 | .90 | 4022 | 1.10 | 4099 | 1.90 |
| 4009 | .45 | 4023 | .35 | 4502 | .90 |
| 4010 | .45 | 4024 | .75 | 4503 | .60 |
| 4011 | .30 | 4025 | .35 | 4508 | 1.90 |
| 4012 | .30 | 4026 | 1.60 | 4510 | .90 |
| 4013 | .45 | 4027 | .60 | 4511 | .90 |
| 4014 | .90 | 4028 | .75 | 4512 | .90 |
| 4015 | .90 | 4029 | .90 | 4514 | 1.20 |
| 4016 | .45 | 4030 | .45 | 4515 | 2.20 |
| | | 4034 | 2.90 | 4516 | 1.50 |
| | | 4035 | .85 | 4518 | 1.20 |
| | | 4040 | .90 | 4519 | 1.20 |
| | | 4041 | 1.20 | 4520 | 1.20 |
| | | 4042 | .75 | 4522 | 1.20 |
| | | 4043 | .75 | 4526 | 1.20 |
| | | 4044 | .75 | 4527 | 1.90 |
| | | 4046 | .90 | 4528 | 1.20 |
| | | 4047 | .90 | 4531 | .90 |
| | | 4049 | .50 | 4532 | 1.90 |
| | | 4050 | .50 | 4538 | 1.90 |
| | | 4015 | .90 | 4539 | 1.90 |
| | | 4053 | .90 | 4543 | 2.70 |
| | | 4060 | 1.39 | 4555 | .90 |
| | | 4066 | .75 | 4556 | .90 |
| | | 4068 | .39 | 4581 | 1.90 |
| | | 4069 | .30 | 4582 | 1.90 |
| | | 4070 | .35 | 4584 | .90 |
| | | 4071 | .30 | 4585 | .90 |
| | | 4072 | .30 | | |
| | | 4073 | .30 | 80C07 | .90 |
| | | 4075 | .30 | 80C95 | .90 |
| | | 4076 | .90 | 80C96 | .90 |
| | | 4078 | .30 | 80C97 | .90 |
| | | 4081 | .30 | 80C98 | 1.15 |

Do Kay Computer Products, Inc.
3250 Keller Street, #9
Santa Clara, CA 95050
(800) 538-8800
Local Calif. Residents (408) 988-0697

STORE HOURS:
MON-FRI 8:30 A.M.-6:00 P.M.
SAT 10:00 A.M.-3:00 P.M.



TERMS: For shipping include \$2.00 for UPS Ground, \$3.00 for UPS Blue Label Air. \$10.00 minimum order. Bay Area residents add 6 1/2% Sales Tax. California residents add 6% Sales Tax. We reserve the right to limit quantities and substitute manufacturer. Prices subject to change without notice. Send SASE for complete list.

LIQUIDATION CLOSEOUT!

BUY DIRECT AND SAVE Due to the increasing costs of warehousing, Mura is forced to discount its current stock of DVOM's to make room for new inventory. This means you can purchase these fine instruments direct from Mura at an extremely advantageous price.

These prices are in effect only while current supplies last, so order the Mura DVOM you need today.

MURA® Model LCD-200

■ 3½ digit readout ■ Large, easy-to-read ½" LCD display ■ Automatic probe function switching ■ 200 hr. continuous use battery life ■ DC V, .001-1000 DC mA, .1-200 AC V 1-500 K ohms 1-2M ■ Size: 5¾" x 3⅞" x 1⅝" ■ Weight: 12 oz. (incl. "AA" cells) ■ Test leads & batteries incl.

An optional carrying case is available @ \$4.95 each

\$39.95



MURA® Model LCD-250

■ 3½ digit readout ■ Large, easy-to-read ½" LCD display ■ Automatic probe function switching ■ DC V, .7 mV-1 kV AC V .7 mV-.7 kV ■ AC/DC Current—.1 uA-1A Ohms—.7-20 M ■ Size: 6" x 3¾" x 1½" Weight: 12 oz. (incl. 9V batteries) Test leads, batteries & carrying case included

\$49.95



GUARANTEE—

If not completely satisfied with your Mura DVOM, return it to Mura within 10 days of receipt for a full refund (less postage and handling)

ORDERING INFORMATION—

Check or M.O. payable to Mura Corp.—Add \$2.00 per unit for shipping and handling—N.Y. residents add appropriate sales tax—Allow 4-6 weeks delivery

Mura Corp. (Dept. RE)
177 Cantiague Rock Road
Westbury, N.Y. 11590

Please send

_____ LCD-200 @ \$39.95 ea.

_____ LCD-250 @ \$49.95 ea.

_____ LCD-200 carrying case @ \$4.95 ea.

Total \$ _____ amount of order.

Name _____

Address _____

City _____

State _____ Zip _____



AMAZING DEVICES

PHASORS
PHASOR PAIN FIELD — Patented and recently developed in our labs is being tested by Gov't for riot control. Soon to come under weapons restrictions as an infernal machine. Easily hand-held. Hazardous IF NOT USED WITH DISCRETION
PPF-1 PLANS (sold for animal control) **\$15.00**
INVISIBLE PAIN FIELD GENERATOR — Produces a directional field of moderately intense pain to back of head up to 50'. Cigarette pack size enclosure is easily hidden
IPG-3 PLANS **\$7.00** IPG-3K KIT & PLANS **\$44.50**
IPG-30 (assembled for animal control) **\$59.50**
PHASOR STUN/BURNING WAND — Produces sufficient electrical energy capable of burning flesh. Intended as a personal defense device.
PSW-3 PLANS **\$8.00** PSW-3K KIT & PLANS **\$59.50**

LASERS
RUBY LASER RAY PISTOL — Intense visible red, burns, hazardous, with parts sources. **\$15.00**
RUBY PLANS (includes all part sources) **\$15.00**
CARBON DIOXIDE LASER — Generates 20-40 watts of continuous power capable of burning, cutting, hazardous, (with all part sources) **\$15.00**
LASER RIFLE — Produces 200-3000 pulses of 30 watt optical energy. Portable and easily hand-held.
LRG-3 PLANS **\$10.00**
LRG-3K KIT PLANS (minus diode) **\$129.50**
POCKET LASER — For the beginner, visible red optical version, non-hazardous.
LHC-2 **\$5.00** LHC-2K KIT & PLANS **\$24.50**
HIGH POWERED PORTABLE ENERGY SOURCE FOR LASERS AND MAGNETIC WEAPONS — Exploding wires, shockwave, etc. Miniature size.
HPS-1 PLANS **\$8.00** HPS-1K KIT & PLANS **\$49.50**
PARTICLE BEAM WEAPON — PLANS **\$15.00**

SECURITY
INFINITY XMTR — Uses telephone lines for selective home or office listening while away on business or vacation.
INF-1 PLANS **\$15.00**
SEE IN DARK — Long range, total darkness.
SD-4 PLANS **\$10.00**
LONG RANGE WIRELESS MIKE — Crystal clear quality — miniature.
FBT-7 PLANS **\$7.00** FBT-7K PLANS & KIT **\$34.50**
WIRELESS TELEPHONE TRANSMITTER — Long range, automatic.
VWPM-5 PLANS **\$10.00** VWPM-5K PLANS & KIT **\$34.50**

Send for **FREE** catalog description of above plus hundreds more plans, kits and completed items. We accept MC or Visa or when ordering, send check or money order. We pay shipping charges on orders over \$50.00, otherwise include 10% with remittance.
SEND TO: **SCIENTIFIC SYSTEMS**
DEPT. R8, BOX 716, AMHERST, N.H. 03031

ELECTRONIC KITS FROM HAL-TRONIX

2304 MHZ DOWN CONVERTERS. TUNES IN ON CHANNELS 2 TO 7 ON YOUR OWN HOME T.V. HAS FREQUENCY RANGE FROM 2000 MHZ TO 2500 MHZ. EASY TO CONSTRUCT AND COMES COMPLETE WITH ALL PARTS INCLUDING A DIE-CAST ALUM CASE AND COAX FITTINGS. REQUIRE A VARIABLE POWER SUPPLY AND ANTENNA (Antenna can be a dish type or coffee can type depending on the signal strength in your area.)

2304 MOD 1 (Basic Kit) **\$19.95**
(Less case & fittings)
2304 MOD 2 (Basic-Pre-amp) **\$29.95**
(Less case & fittings)
2304 MOD 3 (Hi-Gain Pre-amp) **\$39.95**
(Includes case & fittings)
POWER SUPPLY FOR EITHER MODEL ABOVE IS AVAILABLE. COMES COMPLETE WITH ALL PARTS, CASE, TRANSFORMER, ANTENNA SWITCH AND CONNECTORS (Kit) **\$24.95**
Assembled **\$34.95**
Slotted Microwave Antenna For Above
Downconverters **\$39.95**

PREAMPLIFIERS

HAL PA-19—1.5 mhz to 150 mhz. 19db gain operates on 8 to 18 volts at 10ma. Complete unit **\$8.95**
HAL PA-1.4—3 mhz to 1.4 ghz. 10 to 12 db gain operates on 8 to 18 volts at 10 ma. Complete unit **\$12.95**.
(The above units are ideal for receivers, counters, etc.)

16 LINE TOUCH TONE DECODE KIT WITH P.C. BOARD AND PARTS **\$69.95**
12 LINE TOUCH TONE DECODER KIT WITH P.C. BOARD AND PARTS **\$39.95**
16 LINE ENCODER KIT, COMPLETE WITH CASE, PAD AND COMPONENTS **\$39.95**
12 LINE ENCODER KIT, COMPLETE WITH CASE, PAD AND COMPONENTS **\$29.95**

Complete Sets of P.C. Boards Available For: Unicorn Robot Project and Heart-A-Matic Project.
MANY, MANY OTHER KITS AVAILABLE

Send 20 cents stamp or S.A.S.E. for information and flyer on other HAL-TRONIX products. To order by phone: 1-313-285-1782.



HAL-TRONIX
P.O. Box 1101
Southgate, MI 48195

SHIPPING INFORMATION:

ORDERS OVER \$25.00 WILL BE SHIPPED POSTPAID EXCEPT ON ITEMS WHERE ADDITIONAL CHARGES ARE REQUESTED. ON ORDERS LESS THAN \$25.00 PLEASE INCLUDE ADDITIONAL \$2.00 FOR HANDLING AND MAILING CHARGES.

CIRCLE 86 ON FREE INFORMATION CARD

Poly Paks

THIS MONTH'S PAK SPECIALS!!!

TIMEX Sinclair 1000 SOFTWARE CASSETTES

• Add Fun & Utility to Your Personal Computer with Pre-Programmed Cassettes by Timex Sinclair

• Available in a Wide Range of Home, Business, & Entertainment Formats

As Low As **\$9.95**

| | | | |
|-----------------------------------|---------|----------------------------|---------|
| A7492 VU-CALC | \$19.95 | A7500 Chess | \$14.95 |
| A7493 Inventory Control | \$19.95 | A7504 Grimm's Fairy Trails | \$14.95 |
| A7495 Critical Path Analysis | \$19.95 | A7489 The Car Pooler | \$14.95 |
| A7494 Manufacturing Control | \$19.95 | A7497 Super Math | \$14.95 |
| A7499 Flight Simulator | \$19.95 | A7502 The Gambler | \$14.95 |
| A7491 The Stock Option Analyzer | \$16.95 | A7501 Backgammon | \$14.95 |
| A7484 The Organizer | \$16.95 | A7488 The Coupon Manager | \$12.95 |
| A7490 The Stamp Collector | \$16.95 | A7503 The Cube Game | \$12.95 |
| A7487 The Checkbook Manager | \$15.95 | A7498 States & Capitals | \$12.95 |
| A7485 The Budgeter | \$15.95 | A7505 The Mixed Game Bag 1 | \$9.95 |
| A7486 The Loan Mortgage Amortizer | \$14.95 | A7496 Statistics | \$9.95 |

THIS MONTH'S PAK SPECIALS!!!

VIC-20 SOFTWARE AND PERIPHERALS

MEMORY EXPANSION & PROGRAMMING AID CARTRIDGES

| | | |
|-----------------------------------|-------|---------|
| VIC 8K Memory Expander Cartridge | A7524 | \$54.00 |
| VIC 16K Memory Expander Cartridge | A7525 | \$95.00 |
| VIC-20 Super Expander | A7557 | \$54.00 |
| Programmers Aid Cartridge | A7558 | \$49.00 |
| VICMON Machine Language Monitor | A7559 | \$49.00 |

APPLICATION PROGRAMS ON DISC

| | | |
|--|-------|---------|
| Recreational Program Pack | A7567 | \$49.00 |
| Home Calculation Program Pack | A7568 | \$49.00 |
| Programmable Character Set/Gamegraphics Editor | A7569 | \$13.49 |
| VIC Term I—Terminal Emulator | A7570 | \$ 8.95 |

ACCESSORIES

| | | |
|--|-------|---------|
| VIC-20 Programmers Reference Guide | A7527 | \$14.95 |
| Introduction to BASIC Programming-Part 1 | A7534 | \$21.00 |
| VIC Graphic Printer Paper | A7528 | \$10.00 |
| VIC Printer Ribbon Cartridge | A7529 | \$ 8.00 |

THIS MONTH'S PAK SPECIALS!!!

VIC GAME CARTRIDGES

| | | |
|----------------------|-------|---------|
| COSMIC CRUNCHER | A7536 | \$24.00 |
| GOLF | A7537 | \$34.00 |
| OMEGA RACE | A7538 | \$34.00 |
| MONEY WARS | A7539 | \$24.00 |
| MENAGERIE | A7540 | \$24.00 |
| COSMIC JAILBREAK | A7541 | \$24.00 |
| VIC AVENGER | A7542 | \$24.00 |
| SUPERLOT | A7543 | \$24.00 |
| VIC SUPER ALIEN | A7544 | \$24.00 |
| JUPITER LANDER | A7545 | \$24.00 |
| DRAW POKER | A7546 | \$24.00 |
| MIDNIGHT DRIVE | A7547 | \$24.00 |
| RADAR RAY RACE | A7548 | \$24.00 |
| RAID ON FT. KNOX | A7549 | \$24.00 |
| SARGON II CHESS | A7550 | \$34.00 |
| SUPER SMASH | A7551 | \$34.00 |
| CLOWNS | A7552 | \$24.00 |
| GARDEN WARS | A7553 | \$24.00 |
| SEA WOLF | A7554 | \$34.00 |
| ADVENTURE LAND | A7555 | \$34.00 |
| PIRATE COVE | A7556 | \$34.00 |
| MISSION IMPOSSIBLE | A7557 | \$34.00 |
| THE COUNT | A7561 | \$34.00 |
| VOO DOO CASTLE | A7562 | \$34.00 |
| MOLE ATTACK | A7563 | \$24.00 |
| HOME BABY SITTER | A7564 | \$24.00 |
| VISIBLE SOLAR SYSTEM | A7565 | \$24.00 |
| PERSONAL FINANCE | A7566 | \$34.00 |

Expand Your ZX81 or Timex Sinclair 1000 with

MEMOTECH ADD-ONS!

All Memotech products come in attractive, custom designed cases styled to plug firmly into the Sinclair "piggy-back" fashion, requiring no additional power supply or leads

- 64K RAM PAK** A7628 **Only \$169.00**
- 32K RAM PAK** A7629 **Only \$ 99.00**
- 16K RAM PAK** A7630 **Only \$ 55.00**

PRINTER INTERFACE A7632 **\$ 99.95**
• For use with Centronics Type Parallel Printers

HI-RES GRAPHICS PAK A7631 **\$139.95**
• Fully Programmable - 192 x 248 pixels
• Number of Video Pages is Limited Only by RAM Size
• Video Page is Both Memory & Bit Mapped & Can be Located Anywhere in RAM
• 30 Graphic Subroutines • Contains 2K EPROM Monitor



TIMEX Sinclair 1000 PERSONAL COMPUTER

Only **\$97**

TIMEX/Sinclair 16K RAM MODULE

Only **\$47**

VIC-20 HOME COMPUTER

Only **\$189**

Cardco 6-Slot EXPANSION INTERFACE BOARD
• Allows Memory Expansion up to 40K
• Accepts up to 6 Games
• Includes System Reset Button
• All Slots are Switch Selectable
A7574 **\$125.95**

Economy 3-Slot Board
• Similar to Above
A7575 **\$26.95**

VIC-20 KEYBOARD

A7517

Vectrex ARCADE SYSTEM

• Built-In High Resolution Screen for Real Arcade Play - No TV Needed!
• Complete With Built-In "Mine Storm" Game

Only **\$197**

ADDITIONAL GAME CARTRIDGES

- Star Trek • Clean Sweep • Blitz
- Armor Attack • Solar Quest • Hyper Chase
- Scramble • Cosmic Chasm • More to Come!
- Berzerk • Star Hawk
- Space Wars • Rip Off

29.95 ea.

ADDITIONAL CONTROL PANEL
• For 2-Player Action M7603 **\$34.95**

Jerrold 58 Channel CORDLESS CABLE TV CONVERTER

Only **\$159** 2/5298 Buy 2-SAVE \$20!

• Receive up to 58 TV Channels - Capacity is Limited Only by the Number of Channels Your Cable Company Carries.
• Wireless Remote Control Unit Controls On/Off, Channel Selection, Channel Slepping, & Fine Tuning, From Any Viewing Distance.
• Attaches to Any Age or Model of TV Set in Minutes. No Tools Required.

Siemens FDD-100-8 8" FLOPPY DISC DRIVE

Lowest Price in the Country! **\$258**

• Single Sided
• Single or Double Density
• Power Requirements
115 VAC @ 60 Hz
+ 24 VDC @ 1.7 A
+ 5 VDC @ 1.2 A

• 77 Tracks, 48 Tracks per Inch
• 800K Double-Density Storage per Disk
• 6 msec Track to Track Access Time
• Size: 4.5" x 8.55" x 14.25"

IC SOCKETS

• Solder tail low profile

| Cat. No. | Description | Was | NOW |
|----------|---------------------|------------|------------|
| O1307 | 10-Pin TO-5 | 4/1.29 | 4/15.16 |
| O1308 | 14-Pin DIP | 4/1.29 | 4/15.16 |
| O4019 | 14-Pin DIP* | 4/1.29 | 4/15.16 |
| O1309 | 16-Pin DIP | 4/1.29 | 4/15.16 |
| O3718 | 18-Pin | 4/1.29 | 4/15.16 |
| O3816 | 24-Pin 5/8" Spacing | 2/1.29 | 2/15.16 |
| O3887 | 28-Pin 5/8" Spacing | 2/1.29 | 2/15.16 |
| O5202 | 40-Pin | \$1.29 ea. | \$1.16 ea. |
| O2123 | 8-Pin Mini-DIP | 4/1.29 | 4/15.16 |

*Wire Wrap

Lambda VOLTAGE REGULATORS

A7301 12V @ 3A, 30 Watts, TO-3 case **\$2.79**
A7300 12V @ 5A, 50 Watts, TO-3 case **\$3.99**

84-Key Microswitch SD-Series Hall Effect, ASCII Compatible

COMPUTER KEYBOARD

A7511

• Full ASCII II Character Set
• Alphabetic Key Section
• Plus Hexadecimal-Style Numeric Keypad
• Features 8 BIT Parallel Output, 40-Pin On-Board AMI Encoder IC
• 16 1/4" x 6" x 1 1/2"

\$29.00

12 Hour Mechanical Drum-Type DIGITAL/ALARM CLOCK

H7481

• Includes Setting & Switching Controls for use in Clock Radio Alarm Clock Applications
• Unit Comes With Color-Coded Insulated Leads for Power & Lamp Hookup, Solder Eyelet Terminals for Radio Alarm Interface
• Requires 115V AC, 60 Hz, 5 Watts
• Size: 6" x 3" x 2 1/2"

Super Low Price **\$3.29**

Motorola In-Dash AM/FM-STEREO PUSHBUTTON RADIO

G7348

• 4W per channel, 8W RMS
• Features: balance & tone control, illuminated slide rule tuning dial
• Size: 6 1/4" x 6 1/4" x 1 3/4" (less faceplate & control knobs)
• Requires 12V DC neg. gnd

With 2 FREE SPEAKERS!

ONLY \$39.00

Corcoran 20 Amp RF/EMI Filter NEW!

A7422

• Mounting Tabs w/Holes on 2.516" Ctr's, Spade Type Push-On Terminals
• Rated: 115/20V 50/60Hz, up to 20 Amps
• Case is Clearly Marked as LINE/LOAD
• Size: 3.38" x 2" x 1.34"

\$8.98

Eastman Kodak 259mm PHOTOCOPY LENS

H7514

• May Be Adapted for use in the Design of Your Own Wide Screen TV Projection System
• Die Cast Threaded Metal Cylinder (w/Locking Rings) Precise 4-Element Construction & Removable Aluminum Mounting Bracket
• Lens: 259mm /f5.6 2 1/2" Dia
• Size: 3-1/4" Dia. x 3-1/8"

\$7.95

Astec TV VIDEO MODULATOR

L7206

• ASTEC type UM-1082
• Video output to 75 Ohm TV input on channel 3 or 4
• Size: 1.58" x 1.18" x 7/8"

Operates on 7VDC

\$4.95

Zenith 12/24 Volt Dual Output PLUG-IN POWER SUPPLY

P7639

• Designed as Power Supply for Top-Of-The-Line Video Decoder Equipment
• Insulated & Color-Coded 6 ft. 3-Conductor Cable
• Input: 120 VAC, 60 Hz, 15 W
• Output: 24 VDC @ 70 mA, 12 VDC @ 290 mA

ONLY **\$5.95**

115 VAC "BLOCK FAN"

B3108

• Low noise level
• Suitable for -40° to +160°F
• Humidity & moisture resistant motor
• Impedance protected
• 15 watts approx. 75 cfm or better
• 4.11/16" sq x 1.12" deep

\$9.98

Simpson Dual-Function 0-15V DC, 0-30 mA VOLT METER

H7478

• Features include: 2 1/2" Square White Face w/Black Legends, Convenient Front Mounted Zero Correct Adjustment Screw, & Four 1/4" Screws w/Hardware

\$3.99 3 for \$12

HOBBYISTS' SUPER-SPECIALS!!!

REJECT "GAS SNIFFERS"

Hobbyist Special: G.C. rejects originally designed to sense toxic gasses & sound alarm

• Each board: 2 1/2" x 5 1/4"

17384 **2 for \$13 \$7.98**

300 MW Wide Band AUDIO AMPLIFIER MODULE

G7626

• Accepts 2 mV Source Input & Delivers 300 mW, 8 Ohm Output
• Requires 6-9 VDC @ 10-15 mA or 6 VAC

\$3.49 3 for \$9

5 Watt Dual Input STEREO AMPLIFIER

G7440

Features include: Independent Volume, Balance & Tone Controls, Pre-Wired Stereo Headphone Jack, Plus 4 Mounted RCA Jacks for Speakers & FM/Tape Input

• Delivers 2.5 W per Channel into 8 - 16 Ohms
• Requires 10 to 16 VAC, 1A Power Transformer (not included)
• Size: 6.38" x 3" x 3.4"

ONLY \$4.88

TANK BATTLE TV GAME BOARD

M6526

• 28-pin DIP w/General Instruments AY-3-8700-1 tank battle game chip & board
• Chip capabilities: 2 individually controlled exploding tanks, 3 speeds, motor & explosion sounds, on-screen scoring & more!

SPECIAL \$6.44

2-SIDED COPPER-CLAD P.C. BOARDS

G7404

• Industrial quality 1/16" FR4 & G10 boards w/0.17" thick 2-sided copper foil
• Pre-cut in a variety of irregularly sized rectangles
• Available in two area ranges:

60 to 100 sq. inches **\$2.99 ea.**
Over 100 sq. inches **\$3.99 ea.**

Fuji/Xerox F.4.5 PHOTOCOPY LENS

H6937

• Build your own wide-screen TV projector—design instructions included!
• Features triple element lens construction & rugged one-piece metal case
• FL 24 cm. x 3 1/4" Dia. x 3"

\$10.88

JUMBO PAKS - NOW 20% BIGGER!!!

Reg. \$2.99 - Now Only **\$2.79 Per Pak!!!**

- 45—UPRIGHT ELECTROS, Wide ass't. from 1 to 300 mtd. various voltages, 100% marked & good. **F3226**
- 80—DIPPED MICA CAPS, Popular assortment of styles & values included "Silvers", red silvers, etc. **F6621**
- 120—CAP SPECIAL, May include any of countless types, styles & values. All 100% good material. **F0264**
- 120—TUBULAR CAPS, Ass't. (top qual.) values ranging from 100 mtd up to 0.1 mtd. 1000 volts. **F6254**
- 360—PREFORMED 1/2W RESISTORS, Wide ass't. of values, Many 5% & 10% tolerances, top names. **F0246**
- 60—TO-92 RECTIFIERS, Full watt silicon rectifiers, PIV 40V, Vt 0.9V, 1A, 100% material. Top names. **F7232**
- 180—MOLEX SOCKETS, Makes 14, 16, 18, up to 40 pin sockets, M1935-4 type comes "on a strip". **F0255**
- 100—LONG LEAD DISCS, 100% prime, marked stock in assorted sizes & values. **F2590**
- 360—PREFORMED 1/4W RESISTORS, Ass't. values, ideal in many p.c. circuits. **F6622**
- 25—2N3904 TRANSISTORS, Widely used plastic NPN silicon for general switching applications. High yield, TO-92 case. **F6370**

Over 200 to Choose from... Send for FREE CATALOG

MasterCard VISA

SEND FOR FREE CATALOG! ORDER BY MAIL OR CALL: For Merchandise Orders Only

TOLL FREE 800-343-3086

Minimum Merchandise Order—\$15.00
Shipping & Handling Add 5%
Mass. Res. Add 5% Sales Tax
Hrs: Mon-Fri 8:30 a.m. to 5 p.m., Sat 11 to 12:30 p.m. EST

PHONE ORDERS SHIPPED IN **24 HRS.** Except Sat. & Sun



FORMULA INTERNATIONAL INC.

12603 Crenshaw Blvd., Hawthorne, CA 90250

For information (213) 973-1921 • Orders Only (outside Calif.) (800) 672-8758



pineapple™

The Alternative! The Compatible!
The Affordable! 48K Color Computer Kit!

\$645⁰⁰
EACH

(please add 5% shipping and handling)

FEATURES:

- ★ Fully compatible with Apple® II+
- ★ Singleboard for easy assembly
- ★ Popular 6502 MPU for large amount of software
- ★ Game paddle connector on both sides of case
- ★ Built in 2-watt amplifier for realistic sound effect with volume control
- ★ 8 on board peripheral connectors for expansion
- ★ 14 key numeric key-pad
- ★ 5-amp switching power supply

Easy to assemble! All components are clearly silk-screened on the high quality double-sided mother board. All integrated circuits, IC sockets, peripheral connectors, keyboard, switching power supply and the professional high impact plastic case are included.

NEW

High Quality 16K RAM Card Kit

(no cable required)

Same feature as the one we've been selling but without the mess of Dip-wire for Apple® & Pineapple™. **\$59.95** per kit

5 1/4" Flexible Disc Sale

Why buy other brands when you can buy WABASH discs for much less and backed by 1-year factory warranty.

All discs come with Hub Rings

| | | | |
|-----------------|------------------------------|---------------|---------|
| M13A411X | 5 1/4" SSDD Soft Sector | \$2.25 | } 10-99 |
| M43A411X | 5 1/4" SSDD 10 Hard Sector | \$2.25 | |
| M53A411X | 5 1/4" SSDD 16 Hard Sector | \$2.25 | |
| M14A411X | 5 1/4" DSDD Soft Sector | \$3.65 | |
| F111111X | 8" SSDD IBM compatible | \$2.45 | |
| F131211X | 8" SSDD 26 sectors 128 bytes | \$3.05 | |

16K RAM Card Kit For Your Apple® & Pineapple™ Computer



Kit includes:

- High Quality P.C. Board • 8 ea. 4116 (200ns)
- All the IC's & parts • 16-pin Dip wire • Easy to assemble. You can do it in less than 30 minutes!

\$49.95 per kit

5 1/4" Disc Drive 100% Apple® & Pineapple™ Compatible



We did it once, response was great! Now we are doing it again, don't miss it!

\$295.00 ea. w/o controller

\$385.00 ea w/controller

At last! Here's the computer case everyone has been looking for!

Ideal for your homebrew *AP-II 6502 MPU based computer. Made with high impact plastic. Color and shape are compatible with the standard Apple II computers.

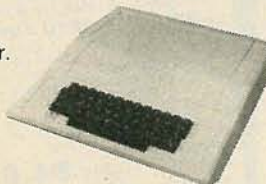

Introductory Offer
\$150.00 ea.

Keyboard not included see our Ad in this page.

MODEL: AP-II

*AP-II model is compatible with Apple II but not manufactured by Apple Computers, Inc. *Apple or Apple II is a registered trade mark of Apple Computers, Inc.

6502 MPU Based Computer Motherboard! You ask for it, you got it!

- ★ 48K on board memory (4116)
- ★ 12K on board EPROM memory (2716 or 2732)
- ★ 8 expansion slots for peripheral cards
- ★ Composite-video output
- ★ size: 14 1/4" x 8 1/2"



\$99.95 ea.

Switching Power Supply For Apple®, AP-II, and Pineapple Computer

Compact size switching power supply.

| | | |
|-----------------------|--------------|--------------|
| Specification: | 4006A | 4007A |
| +5V at | 3A | 5A |
| -5V at | 2A | 3A |
| +12V at | .5A | 1A |
| -12V at | .5A | 1A |



4006A **\$99.00** ea.

4007A **\$145.00** ea.

Size: Width 3 1/2", Depth 9 3/4", Height 2 1/4"

Size and mounting holes will be same as the one used in Apple II.

* Apple is a registered trademark of APPLE COMPUTERS, INC.

SHIPPING AND HANDLING CHARGES

| | | |
|--|-----------------------|-----|
| Under \$50.00 Purchase | Over \$50.00 Purchase | |
| Inside California | 10% | 5% |
| Outside Calif. (Incl. Mexico & Canada) | 15% | 10% |
| Overseas | 25% | 20% |

Minimum Order \$10.00 / Calif. Residents add 6.5% Sales Tax. Phone Orders Accepted on VISA or MC ONLY, NO C.O.D.'s. Prices subject to change without notice.



STORE HOURS
MON-FRI — 10-7
SAT — 10-6



FORMULA INTERNATIONAL INC.

12603 Crenshaw Blvd., Hawthorne, CA 90250

For information (213) 973-1921 • Orders Only (outside Calif.) (800) 672-8758



SUPER FM WIRELESS MIC KIT — MARK III

This new designed circuit uses high FREQ FET transistors with 2 stage pre-amp. Transmits FM range (88-120MHz) up to 2 blocks away and with the ultra sensitive condenser microphone that comes with the kit allows you to pick up any sound within 15 ft. away. Kit includes all electronic parts. OSC coils and PC Board. Power supply 9VDC.

FMC-105
\$11.50 Per Kit



LASER SUPER LANTERN

Brilliant fluorescent lantern with 9" 6 watt fluorescent tube. Features include: Powerful direct beam spotlight with 9V prefocus bulb; Buzzer horn - either constant or time intervals of sonic alarm; Twin blinker - red amber flashing or red & amber flashing on time intervals; fully adjustable nylon strap. Operates from D size batteries or plugs into vehicle cigar lighter socket.

SPECIAL \$16.50



POCKET LIGHT

Complete with 5" fluorescent tube, powerful bulb and handy Strap. Runs on 3 pcs. 15 V "C" size batteries (not included). It's a practical, convenient, powerful spotlight and fluorescent light. Its superior quality is ideal for indoor or outdoor use.

LOW PRICE \$7.50

REGULATED DUAL VOLTAGE SUPPLY KIT

±10-30 VDC @ 250 ma adjustable, fully regulated. Kit includes all electronic parts, filter capacitors, IC's, heat sinks and PC Board.

\$12.50 per kit

MARK V 15 STEPS LED POWER OUTPUT INDICATOR KIT

All functions same as Mark IV but this item comes with heavy-duty aluminum front plate and case. Fits into the front panel of your auto, truck or boat. Operates on 12 V DC.

\$41.50 per kit

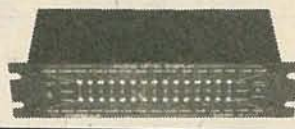

TR-747 DC SERVO POWER SUPPLY FOR TA-2000



DC Servo feedback circuit makes this power supply a must for our TA-2000 amplifier. The TR-747 will monitor the operating conditions of the TA-2000 power amplifiers. MODEL TR-747 \$24.95 per kit

GOOD NEWS FOR HI-FI NUTS!

Introducing our TA-2000 200 watts P.P. Super Mirror Amplifier Kit.

By using four stages of modern P.P. Super Mirror Circuit, THD and TIM are kept under 0.01% at rated output!

SPECIFICATIONS: 200W RMS into 4 or 8 Ω

- 0 to 100,000 Hz (at 1W) +0dB, -1dB
- S/N better than 100dB
- Less than 0.01% total Harmonic Distortion.



MODEL TA-2000
\$83.95 per kit

SANYO UHF VARACTOR TUNER FOR UHF CHANNEL 14-83

Tuning voltage +1-+28VDC. Input impedance 75Ω. IF band width 7-16MHz. Noise figure 11.5dB Max. Size 2 1/4" x 1 1/4" x 3/4". Supply voltage 15VDC.

Model 115-B-403A, Video IF 45.0MHz
Model 115-B-405A, Video IF 62.5MHz
\$35.00 ea.

Tuner is the most important part of the circuit. Don't let those \$19.00 tuners fool you. All units are brand new from Sanyo. When ordering please specify model number.



SANYO ANTENNA SIGNAL BOOSTER

This Booster is specially designed for UHF Channels (14-83). After installing (between the antenna input cable and the UHF tuner), this unit will provide a minimum of 10dB gain, that is approximately 2 times better than you are seeing now. Ideal for those who live in apartments that can not put up an outdoor antenna. Small in size, only 2" x 1 1/2" x 1". Supply voltage is 15 VDC. Back in Stock.

* NEW ITEM *
MODEL 001-0076
\$12.50 ea.



PROFESSIONAL REGULATED VARIABLE DC POWER SUPPLY KIT

MODEL TR88A 0-15VDC @ 2A
MODEL TR88B 0-30VDC @ 1A

All solid state circuitry with high efficiency power transistor 2SD388 and IC voltage regulator MC1733. Output voltage can be adjusted from 0-30V at 1A current limited or 0-15V at 2A current limited. Internal resistance is less than 0.005Ω, ripple and noise less than 1mV, dual on panel meters for voltage and amp reading, also with on board LED and audible over load indicator. Kit comes with pre-drilled PC Board, instructions, all necessary electronic components, transformer and a professional looking metal cabinet. The best project for school and the most useful instrument for repairmen. Build one today!

\$59.50 Per Kit

6-WAY A/C ADAPTOR

Input 110VAC Output 3V, 4.5V, 6V, 7.5V & 12VDC Current 300mA

OUR LOW PRICE \$5.50 each

19" RACK MOUNT CABINETS

Black anodized front panel with black textured case

| WIDTH | DEPTH | HEIGHT | PRICE |
|-------|---------|--------|---------|
| 17" | 11 1/2" | 3" | \$25.50 |
| 17" | 11 1/2" | 5" | \$31.50 |
| 17" | 11 1/2" | 7" | \$39.50 |

No FCC License Required.

OUR PRICE \$49.50
Additional Microphone (Transmitter) Available AT \$26.00 each
MURA WMS-49

CRYSTAL CONTROLLED WIRELESS MICROPHONE SYSTEM

Transmitter: FET mic for flat 30Hz-18KHz response. X'tal controlled 49 MHz AM Band for drift-free performance. 100 MW output (range approx. 1/4 mile) for reliable long range transmission. Powered by a 9V radio battery (included). Receiver: X'tal controlled locks on 49 MHz transmitter signal. On panel VU meter, monitors the signal strength from the microphone. Standard phone jack outlet connection to a P.A. or other phone input. 9V battery included. This professional set is ideal for on stage, in field, church, in house or outdoor use.

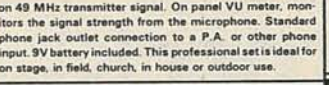

A GOOD BUY at \$65.00

TA-800

120W PURE DC POWER STEREO AMP KIT

Getting power hungry from your small amp? Have to watch your budget? Here's a good solution! The TA-800 is a pure DC amplifier with a built in pre-amp. All coupling capacitors are eliminated to give you a true reproduction of the music. On board tone and volume controls combined with built in power supply make the TA-800 the most compact stereo amp available. Specifications: 60W x 2 into 8Ω. Freq. range: 0Hz-100KHz ±3dB. THD .01% or better. S/N ratio: 80dB. Sensitivity: 3mV into 47K. Power Requirement: ±24-40 Volts.

"FISHER" 30 WATT STEREO AMP

MAIN AMP (15W x 2). Kit includes 2 pcs. Fisher PA 301 Hybrid IC, all electronic parts with PC Board. Power supply ±16VDC (not included). Power band with KF 1% ±3dB. Voltage gain 33dB. 20Hz-20KHz.

Super Buy Only \$18.50

WHISTLE ACTIVATED SWITCH BOARD

All boards are pre-assembled and tested. Your whistle to its FET condenser microphone from a distance, as far as 30 feet away (sensitivity can be easily adjusted), will turn the switch on and if you whistle again, it will turn off. Ideal for remote control toys, electrical appliance such as lights, coffee pots, TV, Hi-Fi, radio or other projects. Unit works on 9VDC.

MODEL 968 \$4.50 ea.

ULTRASONIC SWITCH KIT

Kit includes the Ultra Sonic Transducers, 2 PC Boards for transmitter and receiver, all electronic parts and instructions. Easy to build and a lot of uses such as remote control for TV, garage door, alarm system or counter. Unit operates by 9-12VDC.

\$15.50 ea.

MARK IV — 15 STEP LED POWER LEVEL INDICATOR KIT

This new stereo level indicator kit consists of 36 4-color LED's (15 per channel) to indicate the sound level output of your amplifier from -36dB to +3dB. Comes with a well designed silk screen printed plastic panel and has a selector switch to allow floating or gradual output indicating. Power supply is 6-12VDC with THG on board input sensitivity controls. This unit can work with any amplifier from 1W to 200W! Kit includes 70 pcs driver transistors, 38 pcs matched 4-color LED's, all other electronic components. PC Board and front panel.

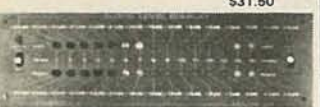

MARK IV KIT \$31.50

AUDIO FREQUENCY SPECTRUM ANALYSER KIT TA-2900

This Audio Frequency Spectrum Analyser analyzes audio signals in 10 octaves over a dynamic range of 30dB. The technique allows the sound coloration introduced by unwanted room and speaker resonances to be substantially eliminated.

The TA-2900 provides a visual presentation of the changing spectrum thru 100 LED displays, so you can actually see proof of the equalized sound you've achieved. The TA-2900 kit comes with all the electronic components, IC's, pre-drilled PC board, the instructions and a 19" Rack Mount type metal cabinet with professional silk-screen printed front panel.

- Input Sensitivity Tape Monitor/10mV - 18mV 50K Ω. Speaker Terminal/0.2W - 100W 8Ω
- Display Level Range (all octaves) 2dB per step/-14dB to -4dB.
- Delay Time (1KHz) Fast/18dB/s Slow/6dB/s
- Power Input 117V or 220V AC 50/60 Hz.
- Power Consumption 36W
- Dimensions 482(W) x 102(H) x 250(D) mm.

\$99.50 per kit



TA-1000 KIT \$51.95
Power Transformer \$24.00 ea.

100W CLASS A POWER AMP KIT

Dynamic Bias Class "A" circuit design makes this unit unique in its class. Crystal clear, 100 watts power output will satisfy the most picky fans. A perfect combination with the TA-1020 low TIM stereo pre-amp.

- Specifications: • Output power 100W RMS into 8Ω, 125W RMS into 4Ω • Frequency response 10Hz-100KHz
- THD less than 0.01% • S/N ratio better than 80dB
- Input sensitivity 1V max. • Power supply ±40V @ 5A.

LOW TIM DC STEREO PRE-AMP KIT TA-1020

Incorporates brand-new DC design that gives a frequency response from 0-100KHz ±0.5dB. Added features like tone defeat and loudness control let you tailor your own frequency supplies to eliminate power fluctuation!

Specifications: • THD/TIM less than .005% • Frequency response DC to 100KHz ±0.5dB • RIAA deviation ±0.2dB • S/N ratio better than 70dB • Sensitivity Phono 2mV 47K/Aux 100mV 100K • Output level 1.3V • Max output 15V • Tone controls Bass ±10dB @ 50Hz/Treble ±10dB @ 15Hz • Power supply ±24VDC @ 0.5A. Kit comes with regulated power supply, all you need is a 48VCT transformer @ 0.5A.

Only \$44.50 X former \$4.50 ea.



TA-323 60 WATTS TOTAL 30W + 30W STEREO AMP KIT

This is a solid state all transistor circuitry with on board stereo pre-amp for most microphone or phone input. Power output employs 2 pairs matching Darlingtons Transistors driven by the popular 2N3053 Driver Transistors. Four built on board controls for, volume, balance, treble and bass. Power supply requires 48VCT 2.5A transformer. THD of less than 0.1% between 100Hz-10KHz at full power. (30 Watts + 30 Watts loaded into 8Ω).

ELECTRONIC SWITCH KIT

CONDENSER TYPE. Touch On - Touch Off. Uses 7473 IC and 12V relay \$5.50

POWER SUPPLY KIT

0-30VDC REGULATED. Uses UA723 and 2N3055 power transistor. Output can be adjusted from 0-30V @ 2A. Complete with PC Board and all electronic parts. TRANSFORMER \$9.50 ea.

FLUORESCENT LIGHT DRIVER KIT

12V DC Powered - Lights up 8-15 Watt Fluorescent Light Tubes. Ideal for camper, outdoor, auto or boat. Kit includes high voltage coil, power transistor, heat sink, all other electronic parts and PC Board. Light tube not included.

\$6.50 Per Kit

ELECTRONIC DUAL SPEAKER PROTECTOR

Cuts off when circuit is shorted or over loaded to protect your amplifier as well as your speakers. A must for OCL circuits. KIT FORM \$8.75 ea.

6W AUDIO AMP KIT

TB810 with Volume Control. Power Supply 6-18VDC Only \$7.50 ea.

FLUORESCENT AUDIO LEVEL MONITOR

This is the kind of VU monitor that is being used by most amplifier manufacturers. IC's are used to simplify circuit layout. Easy to assemble and can be used with all power level amplifiers. Power requirement 12VDC.

TE-221 KIT For Just \$28.50 (limited stock)



* Apple is a registered trademark of APPLE COMPUTERS, INC.

SHIPPING AND HANDLING CHARGES

| Under \$50.00 Purchase | Over \$50.00 Purchase |
|--|-----------------------|
| Inside California 10% | 5% |
| Outside Calif. (Incl. Mexico & Canada) 15% | 10% |
| Overseas 25% | 20% |

Minimum Order \$10.00 / Calif. Residents add 6.5% Sales Tax. Phone Orders Accepted on VISA or MC ONLY. NO C.O.D.'s. Prices subject to change without notice.



STORE HOURS
MON-FRI — 10-7
SAT — 10-6

(602) 266-9758 (602) 234-3026

ARIZONA ELECTRONIC

SURPLUS
Wholesale - Retail - Surplus
Electronic Parts

6835 N. 16th Street • Phoenix, AZ 85016

The Most Unbelievable Electrolytic Sale in the USA!

| AXIAL | | RADIAL | |
|----------|-----------|---------|----------|
| 33/6.3 | 12/1.00 | 15/10 | 20/1.00* |
| 100/6.3 | 10/1.00 | 1000/10 | 12/1.00 |
| 220/6.3 | 20/1.00* | 10/16 | 30/1.00* |
| 470/6.3 | 10/1.00 | 47/16 | 30/1.00* |
| 220/10 | 15/1.00 | 220/16 | 25/1.00* |
| 47/15 | 15/1.00 | 470/16 | 20/1.00* |
| 1000/16 | 10/1.00* | 47/25 | 20/1.00* |
| 2200/16 | 8/1.00* | 1/100 | 15/1.00 |
| 47/35 | 12/1.00 | 47/100 | 5/1.00 |
| 220/35 | 10/1.00 | 100/100 | 4/1.00 |
| 3300/35 | 1.00 each | 4.7/160 | 10/1.00 |
| 4000/35 | 1.00 each | 10/160 | 10/1.00 |
| 15/50 | 20/1.00* | 22/160 | 10/1.00 |
| 22/50 | 20/1.00* | 4.7/250 | 10/1.00 |
| 47/50 | 20/1.00* | 10/250 | 8/1.00 |
| 100/50 | 10/1.00 | 22/250 | 5/1.00 |
| 150/50 | 8/1.00 | 1/350 | 8/1.00 |
| 220/50 | 8/1.00 | 3.3/350 | 6/1.00 |
| 10/75 | 12/1.00 | 10/350 | 6/1.00 |
| 47/100 | 5/1.00* | | |
| 1500/100 | 2/1.00* | | |
| 2.2/150 | 12/1.00 | | |
| 3.3/150 | 12/1.00 | | |
| 47/200 | 5/1.00 | 100/10 | 10/1.00 |
| 1/250 | 15/1.00 | 4/50 | 10/1.00 |
| 2.2/250 | 12/1.00 | 10/50 | 10/1.00 |
| 1/250 | 15/1.00 | 22/50 | 8/1.00 |
| 150/350 | 2/1.00* | 4.7/75 | 4/1.00 |
| 1/500 | 12/1.00 | 10/75 | 4/1.00 |

\$1.00 SPECIALS • \$1.00 SPECIALS • \$1.00 SPECIALS

• \$1.00 SPECIALS

BI-POLAR

YES, All Prices are Correct! • *5% Minimum Order on All Above Capacitors • Some Quantity Pricing Available

MORE \$1.00 SPECIALS

| | |
|----------------------|-----------------------|
| 1N4152 .. 25/*1.00 | 1N5239 .. 20/*1.00 |
| Similar to 1N914 | 9 V. ZENER |
| 1N4001 .. 15/*1.00 | 1N4007 .. 10/*1.00 |
| TIP 3055 .. 3/*1.00 | 2N3055 3/*1.00 |
| MJ 3000 *1.00 | 2N6055. *1.00 |
| Pwr Darlington TO3 | Pwr Darlington TO3 |
| TRIAC 200 V. 30A. | 7 Seg. LED Readout |
| Stud mnt. *1.00 | HP 5082-7650 |
| | 5/*1.00 |
| 4 Pos DIP switch | DIP Relay D.P.S.T. |
| 3/*1.00 | Diode Protect .. 2/*1 |
| D.P.D.T. Rocker Sw | Horz P.C. Trimpots |
| 4 A. 120 VAC | 250Ω, 500Ω, 5kΩ, |
| 3/*1.00 | 10kΩ 4/*1 |
| 2N2142 | MC3420P ... *1.00 |
| 2N3905 | SN75150 *1.00 |
| 2SC828 5/*1.00 | LM3909 *1.00 |
| 2SC644 | |
| SPS7390/ECG123P | RED LED .. 8/*1.00 |
| 5 V. DIP Relay | Transformer .. *1.00 |
| SPST 5/*1.00 | 12 V.C.T. 250 MA |
| 7805 | TO39 Heat Sinks |
| 7812 2/*1.00 | 3/*1.00 |
| MINI D.P.D.T. | |
| Slide 4/*1.00 | |

39.95 MICROWAVE DOWN CONVERTER KIT (HMR II type)
\$24.95

PC Bd., 3-MRF901's, 2-MBD 101's
1 Thermistor, 1 Choke, 3-Chip Caps,
1 "F" Connector, 8 Resistors + Instructions

DOWN CONVERTER PWR. SUPPLY
\$24.95 NEW! 8-12 V.D.C. or 12-18 V.D.C.

ITEMS MC, VISA, COD VIA UPS
(Plus Shipping/Handling)

Graymark Electronic Kits

Quality Products for 18 Years

Sound Operated Switch

Switch AC ON or OFF with just a clap of your hands. Latching Circuit with Sensitivity Control. AC operated. Includes all necessary parts, PCB and instructions.

Order Model 147B

Only \$13.20 each



Digital Car Clock

4 digit mini-LED display, adjustable crystal time base for accuracy, IC clock chip, 12V operation. PCB, instructions and all parts included.

Order Model 139B

Only \$19.30 each

Double Fuzz Box

Hook between amplifier and guitar for expanded sound. Select different Fuzz 1 or Fuzz 2 sounds. Battery operated. Parts, PCB and instructions are all included.

Order Model 138B

Only \$16.60 each

Battery Checker

Unique bar graph LED readout shows condition of 1.5V or 9V batteries. Precision resistance ladder. Battery operated. Comes complete with parts, instructions and PCB.

Order Model 136B

Only \$11.90 each

FM Wireless Mic

Broadcast through any FM radio or listen without being seen. High sensitivity. Battery operated. Comes complete with parts, PCB and instructions.

Order Model 143B

Only \$9.70 each



MC & VISA orders only call Toll Free

800-854-7393

(In CA 714-540-5480)

Send \$1.00 for Catalog (over 60 Kits)

(Refundable with 1st Order)

Graymark

Box 17359 • Irvine, CA 92713

SATISFACTION GUARANTEED

| <p>TUSA A WHOLE NEW WORLD OF TV VIEWING WITH TUSA'S NEW MODEL CVU-40 40 CHANNEL CABLE TV CONVERTER. Receive all the EXTRA CABLE TV "MIDBAND" & SUPERBAND CHANNELS on your UHF DIAL. Eliminates the need for renting or leasing. This stable and reliable system converts extra cable TV channels so they can be received on the UHF tuner of your TV set. A MUST FOR VIDEO-TAPING FROM CABLE TV! The system allows you to program both pay (pay TV decoder required) and standard cable channels for taping on any VCR - while you are watching a different channel on your TV. Simple to install and operate on any make of TV with UHF. NOW AVAILABLE NEW TUNEABLE DELUXE MODEL CVU-1000 \$34.95 ea.</p> | <p>UHF TUNERS Continuous Tune Model While They Last \$3.50 ea. 5 or more \$2.25 ea.</p> | <p>POPULAR IC's TOP QUALITY NO SECONDS</p> <table border="1"> <thead> <tr> <th>TYPE</th> <th>DESCRIPTION</th> <th>1-8</th> <th>10-UP</th> </tr> </thead> <tbody> <tr> <td>LM-380N</td> <td>2 watt Audio Power Amp</td> <td>\$1.49</td> <td>\$1.12</td> </tr> <tr> <td>LM-380N-3</td> <td>Low Voltage Audio Amp</td> <td>1.59</td> <td>1.19</td> </tr> <tr> <td>500WV</td> <td></td> <td>3.50</td> <td>2.69</td> </tr> <tr> <td>NE-564N</td> <td>Digital Phase Locked Loop</td> <td>1.49</td> <td>1.12</td> </tr> <tr> <td>LM-565N</td> <td>Phase Locked Loop</td> <td>1.59</td> <td>1.27</td> </tr> <tr> <td>LM-733N</td> <td>Video Amp</td> <td>2.49</td> <td>1.87</td> </tr> <tr> <td>MC-1330</td> <td>Video Detector</td> <td>2.06</td> <td>1.55</td> </tr> <tr> <td>MC-1349</td> <td>Video If Amp</td> <td>1.75</td> <td>1.31</td> </tr> <tr> <td>MC-1350</td> <td>Video If Amp</td> <td>2.69</td> <td>2.09</td> </tr> <tr> <td>MC-1352</td> <td>Video If Amp AGC</td> <td>1.59</td> <td>1.46</td> </tr> <tr> <td>MC-1358</td> <td>Audio If Amp</td> <td>3.19</td> <td>2.39</td> </tr> <tr> <td>MC-1374P</td> <td>R.F. Modulator</td> <td>88</td> <td>66</td> </tr> <tr> <td>MC-1458</td> <td>Dual Comp. Op Amp</td> <td>1.79</td> <td>1.34</td> </tr> <tr> <td>MC-1468N</td> <td>Balanced Mod/Demodulator</td> <td>4.49</td> <td>3.37</td> </tr> <tr> <td>LM-1800</td> <td>PLL Stereo Decoder</td> <td>2.95</td> <td>2.21</td> </tr> <tr> <td>LM-1809</td> <td>Video Modulator</td> <td></td> <td></td> </tr> <tr> <td colspan="4">LINEAR VOLTAGE REGULATORS</td> </tr> <tr> <td>LM-7805</td> <td>5 Volt Positive Volt. Reg.</td> <td>1.39</td> <td>1.04</td> </tr> <tr> <td>LM-7808</td> <td>8 Volt Positive Volt. Reg.</td> <td>1.39</td> <td>1.04</td> </tr> <tr> <td>LM-7812</td> <td>12 Volt Positive Volt. Reg.</td> <td>1.39</td> <td>1.04</td> </tr> <tr> <td>LM-7815</td> <td>15 Volt Positive Volt. Reg.</td> <td>1.39</td> <td>1.04</td> </tr> <tr> <td>LM-7818</td> <td>18 Volt Positive Volt. Reg.</td> <td>1.39</td> <td>1.04</td> </tr> <tr> <td>LM-7824</td> <td>24 Volt Positive Volt. Reg.</td> <td>1.39</td> <td>1.04</td> </tr> </tbody> </table> | TYPE | DESCRIPTION | 1-8 | 10-UP | LM-380N | 2 watt Audio Power Amp | \$1.49 | \$1.12 | LM-380N-3 | Low Voltage Audio Amp | 1.59 | 1.19 | 500WV | | 3.50 | 2.69 | NE-564N | Digital Phase Locked Loop | 1.49 | 1.12 | LM-565N | Phase Locked Loop | 1.59 | 1.27 | LM-733N | Video Amp | 2.49 | 1.87 | MC-1330 | Video Detector | 2.06 | 1.55 | MC-1349 | Video If Amp | 1.75 | 1.31 | MC-1350 | Video If Amp | 2.69 | 2.09 | MC-1352 | Video If Amp AGC | 1.59 | 1.46 | MC-1358 | Audio If Amp | 3.19 | 2.39 | MC-1374P | R.F. Modulator | 88 | 66 | MC-1458 | Dual Comp. Op Amp | 1.79 | 1.34 | MC-1468N | Balanced Mod/Demodulator | 4.49 | 3.37 | LM-1800 | PLL Stereo Decoder | 2.95 | 2.21 | LM-1809 | Video Modulator | | | LINEAR VOLTAGE REGULATORS | | | | LM-7805 | 5 Volt Positive Volt. Reg. | 1.39 | 1.04 | LM-7808 | 8 Volt Positive Volt. Reg. | 1.39 | 1.04 | LM-7812 | 12 Volt Positive Volt. Reg. | 1.39 | 1.04 | LM-7815 | 15 Volt Positive Volt. Reg. | 1.39 | 1.04 | LM-7818 | 18 Volt Positive Volt. Reg. | 1.39 | 1.04 | LM-7824 | 24 Volt Positive Volt. Reg. | 1.39 | 1.04 |
|--|---|--|--|-------------|-----|-------|---------|------------------------|--------|--------|-----------|-----------------------|------|------|-------|--|------|------|---------|---------------------------|------|------|---------|-------------------|------|------|---------|-----------|------|------|---------|----------------|------|------|---------|--------------|------|------|---------|--------------|------|------|---------|------------------|------|------|---------|--------------|------|------|----------|----------------|----|----|---------|-------------------|------|------|----------|--------------------------|------|------|---------|--------------------|------|------|---------|-----------------|--|--|----------------------------------|--|--|--|---------|----------------------------|------|------|---------|----------------------------|------|------|---------|-----------------------------|------|------|---------|-----------------------------|------|------|---------|-----------------------------|------|------|---------|-----------------------------|------|------|
| TYPE | DESCRIPTION | 1-8 | 10-UP | | | | | | | | | | | | | | | | | | | | | | | | | | | | | | | | | | | | | | | | | | | | | | | | | | | | | | | | | | | | | | | | | | | | | | | | | | | | | | | | | | | | | | | | | | | | | | | |
| LM-380N | 2 watt Audio Power Amp | \$1.49 | \$1.12 | | | | | | | | | | | | | | | | | | | | | | | | | | | | | | | | | | | | | | | | | | | | | | | | | | | | | | | | | | | | | | | | | | | | | | | | | | | | | | | | | | | | | | | | | | | | | | | |
| LM-380N-3 | Low Voltage Audio Amp | 1.59 | 1.19 | | | | | | | | | | | | | | | | | | | | | | | | | | | | | | | | | | | | | | | | | | | | | | | | | | | | | | | | | | | | | | | | | | | | | | | | | | | | | | | | | | | | | | | | | | | | | | | |
| 500WV | | 3.50 | 2.69 | | | | | | | | | | | | | | | | | | | | | | | | | | | | | | | | | | | | | | | | | | | | | | | | | | | | | | | | | | | | | | | | | | | | | | | | | | | | | | | | | | | | | | | | | | | | | | | |
| NE-564N | Digital Phase Locked Loop | 1.49 | 1.12 | | | | | | | | | | | | | | | | | | | | | | | | | | | | | | | | | | | | | | | | | | | | | | | | | | | | | | | | | | | | | | | | | | | | | | | | | | | | | | | | | | | | | | | | | | | | | | | |
| LM-565N | Phase Locked Loop | 1.59 | 1.27 | | | | | | | | | | | | | | | | | | | | | | | | | | | | | | | | | | | | | | | | | | | | | | | | | | | | | | | | | | | | | | | | | | | | | | | | | | | | | | | | | | | | | | | | | | | | | | | |
| LM-733N | Video Amp | 2.49 | 1.87 | | | | | | | | | | | | | | | | | | | | | | | | | | | | | | | | | | | | | | | | | | | | | | | | | | | | | | | | | | | | | | | | | | | | | | | | | | | | | | | | | | | | | | | | | | | | | | | |
| MC-1330 | Video Detector | 2.06 | 1.55 | | | | | | | | | | | | | | | | | | | | | | | | | | | | | | | | | | | | | | | | | | | | | | | | | | | | | | | | | | | | | | | | | | | | | | | | | | | | | | | | | | | | | | | | | | | | | | | |
| MC-1349 | Video If Amp | 1.75 | 1.31 | | | | | | | | | | | | | | | | | | | | | | | | | | | | | | | | | | | | | | | | | | | | | | | | | | | | | | | | | | | | | | | | | | | | | | | | | | | | | | | | | | | | | | | | | | | | | | | |
| MC-1350 | Video If Amp | 2.69 | 2.09 | | | | | | | | | | | | | | | | | | | | | | | | | | | | | | | | | | | | | | | | | | | | | | | | | | | | | | | | | | | | | | | | | | | | | | | | | | | | | | | | | | | | | | | | | | | | | | | |
| MC-1352 | Video If Amp AGC | 1.59 | 1.46 | | | | | | | | | | | | | | | | | | | | | | | | | | | | | | | | | | | | | | | | | | | | | | | | | | | | | | | | | | | | | | | | | | | | | | | | | | | | | | | | | | | | | | | | | | | | | | | |
| MC-1358 | Audio If Amp | 3.19 | 2.39 | | | | | | | | | | | | | | | | | | | | | | | | | | | | | | | | | | | | | | | | | | | | | | | | | | | | | | | | | | | | | | | | | | | | | | | | | | | | | | | | | | | | | | | | | | | | | | | |
| MC-1374P | R.F. Modulator | 88 | 66 | | | | | | | | | | | | | | | | | | | | | | | | | | | | | | | | | | | | | | | | | | | | | | | | | | | | | | | | | | | | | | | | | | | | | | | | | | | | | | | | | | | | | | | | | | | | | | | |
| MC-1458 | Dual Comp. Op Amp | 1.79 | 1.34 | | | | | | | | | | | | | | | | | | | | | | | | | | | | | | | | | | | | | | | | | | | | | | | | | | | | | | | | | | | | | | | | | | | | | | | | | | | | | | | | | | | | | | | | | | | | | | | |
| MC-1468N | Balanced Mod/Demodulator | 4.49 | 3.37 | | | | | | | | | | | | | | | | | | | | | | | | | | | | | | | | | | | | | | | | | | | | | | | | | | | | | | | | | | | | | | | | | | | | | | | | | | | | | | | | | | | | | | | | | | | | | | | |
| LM-1800 | PLL Stereo Decoder | 2.95 | 2.21 | | | | | | | | | | | | | | | | | | | | | | | | | | | | | | | | | | | | | | | | | | | | | | | | | | | | | | | | | | | | | | | | | | | | | | | | | | | | | | | | | | | | | | | | | | | | | | | |
| LM-1809 | Video Modulator | | | | | | | | | | | | | | | | | | | | | | | | | | | | | | | | | | | | | | | | | | | | | | | | | | | | | | | | | | | | | | | | | | | | | | | | | | | | | | | | | | | | | | | | | | | | | | | | | |
| LINEAR VOLTAGE REGULATORS | | | | | | | | | | | | | | | | | | | | | | | | | | | | | | | | | | | | | | | | | | | | | | | | | | | | | | | | | | | | | | | | | | | | | | | | | | | | | | | | | | | | | | | | | | | | | | | | | | |
| LM-7805 | 5 Volt Positive Volt. Reg. | 1.39 | 1.04 | | | | | | | | | | | | | | | | | | | | | | | | | | | | | | | | | | | | | | | | | | | | | | | | | | | | | | | | | | | | | | | | | | | | | | | | | | | | | | | | | | | | | | | | | | | | | | | |
| LM-7808 | 8 Volt Positive Volt. Reg. | 1.39 | 1.04 | | | | | | | | | | | | | | | | | | | | | | | | | | | | | | | | | | | | | | | | | | | | | | | | | | | | | | | | | | | | | | | | | | | | | | | | | | | | | | | | | | | | | | | | | | | | | | | |
| LM-7812 | 12 Volt Positive Volt. Reg. | 1.39 | 1.04 | | | | | | | | | | | | | | | | | | | | | | | | | | | | | | | | | | | | | | | | | | | | | | | | | | | | | | | | | | | | | | | | | | | | | | | | | | | | | | | | | | | | | | | | | | | | | | | |
| LM-7815 | 15 Volt Positive Volt. Reg. | 1.39 | 1.04 | | | | | | | | | | | | | | | | | | | | | | | | | | | | | | | | | | | | | | | | | | | | | | | | | | | | | | | | | | | | | | | | | | | | | | | | | | | | | | | | | | | | | | | | | | | | | | | |
| LM-7818 | 18 Volt Positive Volt. Reg. | 1.39 | 1.04 | | | | | | | | | | | | | | | | | | | | | | | | | | | | | | | | | | | | | | | | | | | | | | | | | | | | | | | | | | | | | | | | | | | | | | | | | | | | | | | | | | | | | | | | | | | | | | | |
| LM-7824 | 24 Volt Positive Volt. Reg. | 1.39 | 1.04 | | | | | | | | | | | | | | | | | | | | | | | | | | | | | | | | | | | | | | | | | | | | | | | | | | | | | | | | | | | | | | | | | | | | | | | | | | | | | | | | | | | | | | | | | | | | | | | |
| <p>WINEGARD 75 OHM UHF YAGI ANTENNAS 12 db GAIN CHANNELS 44 - 52 OPTIONAL Winegard UHF Antenna Preamp *16db Gain \$8.95 ea. \$39.95 ea. \$6.95 ea.</p> | <p>BRAND NEW UHF VARACTOR TUNERS Sanyo 45 MHz Output \$24.95 ea. Mitsumi 45 MHz Output \$24.95 ea. Call for Quantity Prices</p> | <p>AC LINE CORDS Gray 18 ga. wire 6 ft. long cable Prestripped and tinned ends for easy installation. 1-9 59c ea. 10-99 49c ea. 100-Up 39c ea.</p> | <p>Special Purchase MV-2109 33pf Tuning Diode 1-9 \$4.99 ea. 10-Up \$3.99 ea. 12 or more \$3.99 ea.</p> | | | | | | | | | | | | | | | | | | | | | | | | | | | | | | | | | | | | | | | | | | | | | | | | | | | | | | | | | | | | | | | | | | | | | | | | | | | | | | | | | | | | | | | | | | | | | | | |
| <p>SPEAKER CABINET Popular speaker cabinets for those famous home brew TV circuits. Speakers included. Cabinet Dimensions: 7 1/4" wide x 9 1/4" high x 5 1/4" deep. Removable 1/8" thick back cover. SC001 \$10.95 ea. 2 or more \$8.95 ea.</p> | <p>POPULAR MICROWAVE PARTS MRF-901 \$2.75 9-Up 2.19 MRF-911 3.46 9-Up 3.12 MBD-10196 CHIP CAPS - .001 mfd30 26-Up30 2N6603 (dormery MRF-902) 11.95</p> | <p>PROJECT BOXES Woodgrain This box is 1 1/4" W. 4 1/4" H. 6 1/2" D with a removable aluminum U-shaped chassis 1 1/4" W. 3 1/4" H. 6" D inside. \$12.50 ea. 4 or more \$10.95 ea.</p> | <p>UHF - VHF - FM SPLITTER 40-900 MHz Ask For RF2TV Low Loss 3.5-4 db. Low VSWR Waterproof 1-9 \$2.49 ea. Housing 10-Up \$1.89 ea.</p> | | | | | | | | | | | | | | | | | | | | | | | | | | | | | | | | | | | | | | | | | | | | | | | | | | | | | | | | | | | | | | | | | | | | | | | | | | | | | | | | | | | | | | | | | | | | | | | |
| <p>3-POSITION COAXIAL PUSH-BUTTON SWITCH For TV & video cassette recorders. Heavily shielded. Provides maximum isolation. 4 "F" connectors accept 75-ohm coaxial cable with F59 fittings. Push button switches are top mounted. Coils for flush wall mounting. 3 7/8-ohm resistors properly terminate any unused position. Size: 3-9/16" x 2 1/4" x 2". SW003 Now \$6.95 ea.</p> | <p>5" DELUXE SPEAKER Handles up to 15 watts. 4 Ohms 3 oz. Ceramic Magnet \$1.89 ea. 10 up \$1.49 ea.</p> | <p>WINEGARD DELUXE A-B SWITCH TV-1051 For CATV - MATV - VCR 75 ohm - 90 db Isolation While They Last \$6.95 ea.</p> | <p>POPULAR MISCELLANEOUS PARTS 10K Volume Control with DPDT switch \$1.49 10-Up 1.19 1/4w 10K Thumbwheel pots 1-12 .39 13-Up .29 Toroids 730-12 .46 20-Up .25 Toroids 737-2 .38 20-Up .25</p> | | | | | | | | | | | | | | | | | | | | | | | | | | | | | | | | | | | | | | | | | | | | | | | | | | | | | | | | | | | | | | | | | | | | | | | | | | | | | | | | | | | | | | | | | | | | | | | |
| <p>ORDER NOW TOLL FREE 800-854-4655 OUTSIDE CALIFORNIA 714-635-5090 INSIDE CALIFORNIA</p> | <p>R.F. ELECTRONICS 1056 N. STATE COLLEGE BLVD., DEPT. R ANAHEIM, CALIFORNIA 92806 PERSONAL CHECKS HELD FOR CLEARANCE MAIL ORDERS WELCOME - INCLUDE POSTAGE - SHIPPED SAME DAY RECEIVED - NO MINIMUM ORDER</p> | <p>OPEN TUES - FRI 10-6 SAT 10-5 CLOSED SUN & MON</p> | <p>Call or write for FREE Mail Order Catalog</p> | | | | | | | | | | | | | | | | | | | | | | | | | | | | | | | | | | | | | | | | | | | | | | | | | | | | | | | | | | | | | | | | | | | | | | | | | | | | | | | | | | | | | | | | | | | | | | | |

DIGI-KEY CORPORATION

In Mn., Ak., Hi. Call 218-881-6674

NATIONAL SEMICONDUCTOR • PANASONIC • QUALITY - Name brand products from nationally recognized manufacturers.
DAVID • CHEMEX • BISHOP GRAPHICS • W. MACHINE • DIAMOND TOOL • UNGAR • GC CH.
ARVAL • FLEURY • MOLEX • DAVID • E. N. AS INSTUMENTS • ITT • A PRODUCTS • DIA
OK MACHINE • UNGAR • GC CHEMICALS • ARIES • UNGAR • GC CHEMICALS • ARIES
NATIONAL SEMICONDUCTOR • PANASONIC • DISC CAPACITORS • ARIES • PLESSEY • MOLEX • E

SAVINGS - Volume Discounts • OEM Quantity Pricing • Toll Free 800 Number
WISA - Computerized order processing and inventory control.

THE DIGI-KEY Difference makes a Big Price Difference. (See below) **DISC CAPACITORS** **NEW! KIT** **NEW! KIT**

INTEGRATED CIRCUITS

| 7400 TTL | 74LS00 TTL | 74000 TTL |
|----------|------------|-----------|
| 7400 | 74LS00 | 74000 |
| 7401 | 74LS01 | 74001 |
| 7402 | 74LS02 | 74002 |
| 7403 | 74LS03 | 74003 |
| 7404 | 74LS04 | 74004 |
| 7405 | 74LS05 | 74005 |
| 7406 | 74LS06 | 74006 |
| 7407 | 74LS07 | 74007 |
| 7408 | 74LS08 | 74008 |
| 7409 | 74LS09 | 74009 |
| 7410 | 74LS10 | 74010 |
| 7411 | 74LS11 | 74011 |
| 7412 | 74LS12 | 74012 |
| 7413 | 74LS13 | 74013 |
| 7414 | 74LS14 | 74014 |
| 7415 | 74LS15 | 74015 |
| 7416 | 74LS16 | 74016 |
| 7417 | 74LS17 | 74017 |
| 7418 | 74LS18 | 74018 |
| 7419 | 74LS19 | 74019 |
| 7420 | 74LS20 | 74020 |
| 7421 | 74LS21 | 74021 |
| 7422 | 74LS22 | 74022 |
| 7423 | 74LS23 | 74023 |
| 7424 | 74LS24 | 74024 |
| 7425 | 74LS25 | 74025 |
| 7426 | 74LS26 | 74026 |
| 7427 | 74LS27 | 74027 |
| 7428 | 74LS28 | 74028 |
| 7429 | 74LS29 | 74029 |
| 7430 | 74LS30 | 74030 |
| 7431 | 74LS31 | 74031 |
| 7432 | 74LS32 | 74032 |
| 7433 | 74LS33 | 74033 |
| 7434 | 74LS34 | 74034 |
| 7435 | 74LS35 | 74035 |
| 7436 | 74LS36 | 74036 |
| 7437 | 74LS37 | 74037 |
| 7438 | 74LS38 | 74038 |
| 7439 | 74LS39 | 74039 |
| 7440 | 74LS40 | 74040 |
| 7441 | 74LS41 | 74041 |
| 7442 | 74LS42 | 74042 |
| 7443 | 74LS43 | 74043 |
| 7444 | 74LS44 | 74044 |
| 7445 | 74LS45 | 74045 |
| 7446 | 74LS46 | 74046 |
| 7447 | 74LS47 | 74047 |
| 7448 | 74LS48 | 74048 |
| 7449 | 74LS49 | 74049 |
| 7450 | 74LS50 | 74050 |
| 7451 | 74LS51 | 74051 |
| 7452 | 74LS52 | 74052 |
| 7453 | 74LS53 | 74053 |
| 7454 | 74LS54 | 74054 |
| 7455 | 74LS55 | 74055 |
| 7456 | 74LS56 | 74056 |
| 7457 | 74LS57 | 74057 |
| 7458 | 74LS58 | 74058 |
| 7459 | 74LS59 | 74059 |
| 7460 | 74LS60 | 74060 |
| 7461 | 74LS61 | 74061 |
| 7462 | 74LS62 | 74062 |
| 7463 | 74LS63 | 74063 |
| 7464 | 74LS64 | 74064 |
| 7465 | 74LS65 | 74065 |
| 7466 | 74LS66 | 74066 |
| 7467 | 74LS67 | 74067 |
| 7468 | 74LS68 | 74068 |
| 7469 | 74LS69 | 74069 |
| 7470 | 74LS70 | 74070 |
| 7471 | 74LS71 | 74071 |
| 7472 | 74LS72 | 74072 |
| 7473 | 74LS73 | 74073 |
| 7474 | 74LS74 | 74074 |
| 7475 | 74LS75 | 74075 |
| 7476 | 74LS76 | 74076 |
| 7477 | 74LS77 | 74077 |
| 7478 | 74LS78 | 74078 |
| 7479 | 74LS79 | 74079 |
| 7480 | 74LS80 | 74080 |
| 7481 | 74LS81 | 74081 |
| 7482 | 74LS82 | 74082 |
| 7483 | 74LS83 | 74083 |
| 7484 | 74LS84 | 74084 |
| 7485 | 74LS85 | 74085 |
| 7486 | 74LS86 | 74086 |
| 7487 | 74LS87 | 74087 |
| 7488 | 74LS88 | 74088 |
| 7489 | 74LS89 | 74089 |
| 7490 | 74LS90 | 74090 |
| 7491 | 74LS91 | 74091 |
| 7492 | 74LS92 | 74092 |
| 7493 | 74LS93 | 74093 |
| 7494 | 74LS94 | 74094 |
| 7495 | 74LS95 | 74095 |
| 7496 | 74LS96 | 74096 |
| 7497 | 74LS97 | 74097 |
| 7498 | 74LS98 | 74098 |
| 7499 | 74LS99 | 74099 |

INTEGRATED CIRCUITS

| 4000 CMOS | Linear | Linear |
|-----------|--------|--------|
| 4000 | LM7331 | LM7331 |
| 4001 | LM7332 | LM7332 |
| 4002 | LM7333 | LM7333 |
| 4003 | LM7334 | LM7334 |
| 4004 | LM7335 | LM7335 |
| 4005 | LM7336 | LM7336 |
| 4006 | LM7337 | LM7337 |
| 4007 | LM7338 | LM7338 |
| 4008 | LM7339 | LM7339 |
| 4009 | LM7340 | LM7340 |
| 4010 | LM7341 | LM7341 |
| 4011 | LM7342 | LM7342 |
| 4012 | LM7343 | LM7343 |
| 4013 | LM7344 | LM7344 |
| 4014 | LM7345 | LM7345 |
| 4015 | LM7346 | LM7346 |
| 4016 | LM7347 | LM7347 |
| 4017 | LM7348 | LM7348 |
| 4018 | LM7349 | LM7349 |
| 4019 | LM7350 | LM7350 |
| 4020 | LM7351 | LM7351 |
| 4021 | LM7352 | LM7352 |
| 4022 | LM7353 | LM7353 |
| 4023 | LM7354 | LM7354 |
| 4024 | LM7355 | LM7355 |
| 4025 | LM7356 | LM7356 |
| 4026 | LM7357 | LM7357 |
| 4027 | LM7358 | LM7358 |
| 4028 | LM7359 | LM7359 |
| 4029 | LM7360 | LM7360 |
| 4030 | LM7361 | LM7361 |
| 4031 | LM7362 | LM7362 |
| 4032 | LM7363 | LM7363 |
| 4033 | LM7364 | LM7364 |
| 4034 | LM7365 | LM7365 |
| 4035 | LM7366 | LM7366 |
| 4036 | LM7367 | LM7367 |
| 4037 | LM7368 | LM7368 |
| 4038 | LM7369 | LM7369 |
| 4039 | LM7370 | LM7370 |
| 4040 | LM7371 | LM7371 |
| 4041 | LM7372 | LM7372 |
| 4042 | LM7373 | LM7373 |
| 4043 | LM7374 | LM7374 |
| 4044 | LM7375 | LM7375 |
| 4045 | LM7376 | LM7376 |
| 4046 | LM7377 | LM7377 |
| 4047 | LM7378 | LM7378 |
| 4048 | LM7379 | LM7379 |
| 4049 | LM7380 | LM7380 |
| 4050 | LM7381 | LM7381 |
| 4051 | LM7382 | LM7382 |
| 4052 | LM7383 | LM7383 |
| 4053 | LM7384 | LM7384 |
| 4054 | LM7385 | LM7385 |
| 4055 | LM7386 | LM7386 |
| 4056 | LM7387 | LM7387 |
| 4057 | LM7388 | LM7388 |
| 4058 | LM7389 | LM7389 |
| 4059 | LM7390 | LM7390 |
| 4060 | LM7391 | LM7391 |
| 4061 | LM7392 | LM7392 |
| 4062 | LM7393 | LM7393 |
| 4063 | LM7394 | LM7394 |
| 4064 | LM7395 | LM7395 |
| 4065 | LM7396 | LM7396 |
| 4066 | LM7397 | LM7397 |
| 4067 | LM7398 | LM7398 |
| 4068 | LM7399 | LM7399 |
| 4069 | LM7400 | LM7400 |

THE DIGI-KEY Difference makes a Big Price Difference.

NEW! KIT **NEW! KIT**

DISC CAPACITORS **NEW! KIT**

NEW! KIT **NEW! KIT**

INTEGRATED CIRCUITS

| 7400 TTL | 74LS00 TTL | 74000 TTL |
|----------|------------|-----------|
| 7400 | 74LS00 | 74000 |
| 7401 | 74LS01 | 74001 |
| 7402 | 74LS02 | 74002 |
| 7403 | 74LS03 | 74003 |
| 7404 | 74LS04 | 74004 |
| 7405 | 74LS05 | 74005 |
| 7406 | 74LS06 | 74006 |
| 7407 | 74LS07 | 74007 |
| 7408 | 74LS08 | 74008 |
| 7409 | 74LS09 | 74009 |
| 7410 | 74LS10 | 74010 |
| 7411 | 74LS11 | 74011 |
| 7412 | 74LS12 | 74012 |
| 7413 | 74LS13 | 74013 |
| 7414 | 74LS14 | 74014 |
| 7415 | 74LS15 | 74015 |
| 7416 | 74LS16 | 74016 |
| 7417 | 74LS17 | 74017 |
| 7418 | 74LS18 | 74018 |
| 7419 | 74LS19 | 74019 |
| 7420 | 74LS20 | 74020 |
| 7421 | 74LS21 | 74021 |
| 7422 | 74LS22 | 74022 |
| 7423 | 74LS23 | 74023 |
| 7424 | 74LS24 | 74024 |
| 7425 | 74LS25 | 74025 |
| 7426 | 74LS26 | 74026 |
| 7427 | 74LS27 | 74027 |
| 7428 | 74LS28 | 74028 |
| 7429 | 74LS29 | 74029 |
| 7430 | 74LS30 | 74030 |
| 7431 | 74LS31 | 74031 |
| 7432 | 74LS32 | 74032 |
| 7433 | 74LS33 | 74033 |
| 7434 | 74LS34 | 74034 |
| 7435 | 74LS35 | 74035 |
| 7436 | 74LS36 | 74036 |
| 7437 | 74LS37 | 74037 |
| 7438 | 74LS38 | 74038 |
| 7439 | 74LS39 | 74039 |
| 7440 | 74LS40 | 74040 |
| 7441 | 74LS41 | 74041 |
| 7442 | 74LS42 | 74042 |
| 7443 | 74LS43 | 74043 |
| 7444 | 74LS44 | 74044 |
| 7445 | 74LS45 | 74045 |
| 7446 | 74LS46 | 74046 |
| 7447 | 74LS47 | 74047 |
| 7448 | 74LS48 | 74048 |
| 7449 | 74LS49 | 74049 |
| 7450 | 74LS50 | 74050 |
| 7451 | 74LS51 | 74051 |
| 7452 | 74LS52 | 74052 |
| 7453 | 74LS53 | 74053 |
| 7454 | 74LS54 | 74054 |
| 7455 | 74LS55 | 74055 |
| 7456 | 74LS56 | 74056 |
| 7457 | 74LS57 | 74057 |
| 7458 | 74LS58 | 74058 |
| 7459 | 74LS59 | 74059 |
| 7460 | 74LS60 | 74060 |
| 7461 | 74LS61 | 74061 |
| 7462 | 74LS62 | 74062 |
| 7463 | 74LS63 | 74063 |
| 7464 | 74LS64 | 74064 |
| 7465 | 74LS65 | 74065 |
| 7466 | 74LS66 | 74066 |
| 7467 | 74LS67 | 74067 |
| 7468 | 74LS68 | 74068 |
| 7469 | 74LS69 | 74069 |
| 7470 | 74LS70 | 74070 |
| 7471 | 74LS71 | 74071 |
| 7472 | 74LS72 | 74072 |
| 7473 | 74LS73 | 74073 |
| 7474 | 74LS74 | 74074 |
| 7475 | 74LS75 | 74075 |
| 7476 | 74LS76 | 74076 |
| 7477 | 74LS77 | 74077 |
| 7478 | 74LS78 | 74078 |
| 7479 | 74LS79 | 74079 |
| 7480 | 74LS80 | 74080 |
| 7481 | 74LS81 | 74081 |
| 7482 | 74LS82 | 74082 |
| 7483 | 74LS83 | 74083 |
| 7484 | 74LS84 | 74084 |
| 7485 | 74LS85 | 74085 |
| 7486 | 74LS86 | 74086 |
| 7487 | 74LS87 | 74087 |
| 7488 | 74LS88 | 74088 |
| 7489 | 74LS89 | 74089 |
| 7490 | 74LS90 | 74090 |
| 7491 | 74LS91 | 74091 |
| 7492 | 74LS92 | 74092 |
| 7493 | 74LS93 | 74093 |
| 7494 | 74LS94 | 74094 |
| 7495 | 74LS95 | 74095 |
| 7496 | 74LS96 | 74096 |
| 7497 | 74LS97 | 74097 |
| 7498 | 74LS98 | 74098 |
| 7499 | 74LS99 | 74099 |

INTEGRATED CIRCUITS

| 4000 CMOS | Linear | Linear |
|-----------|--------|--------|
| 4000 | LM7331 | LM7331 |
| 4001 | LM7332 | LM7332 |
| 4002 | LM7333 | LM7333 |
| 4003 | LM7334 | LM7334 |
| 4004 | LM7335 | LM7335 |
| 4005 | LM7336 | LM7336 |
| 4006 | LM7337 | LM7337 |
| 4007 | LM7338 | LM7338 |
| 4008 | LM7339 | LM7339 |
| 4009 | LM7340 | LM7340 |
| 4010 | LM7341 | LM7341 |
| 4011 | LM7342 | LM7342 |
| 4012 | LM7343 | LM7343 |
| 4013 | LM7344 | LM7344 |
| 4014 | LM7345 | LM7345 |
| 4015 | LM7346 | LM7346 |
| 4016 | LM7347 | LM7347 |
| 4017 | LM7348 | LM7348 |
| 4018 | LM7349 | LM7349 |
| 4019 | LM7350 | LM7350 |
| 4020 | LM7351 | LM7351 |
| 4021 | LM7352 | LM7352 |
| 4022 | LM7353 | LM7353 |
| | | |

QUALITY parts at DISCOUNT PRICES



2-WAY CAR STEREO SPEAKER SYSTEM

THESE SPEAKERS COME IN HEAT RESISTANT ABS CABINETS... EACH CONTAIN A 4" 10 OZ WOOFER AND 2" TWEETER, 15 WATT NOM., 45 WATT MAX. POWER RATING. COMPARE TO \$80.00 VALUE... SPECIAL PRICE... \$36.00 PER PAIR.....

JOYSTICK
PRECISION DEVICE... CONTAINS 4 50K CENTER TAPPED ALPS POTS. \$4.75 ea



BLACK PLASTIC CASE



PAC-TEC SERIES C
BLACK PLASTIC ENCLOSURE ADJUSTABLE HEIGHT FROM 1.63" TO 2.93"; WIDTH 6.85"; DEPTH 8". BUILT-IN STAND OFFS FOR P.C. BOARDS... FRONT AND BACK PANELS NOT INCLUDED... \$5.25 PER CASE

VARIABLE DIODE 16 PF
MV2205 2 FOR \$1.00
100 FOR \$30.00
BB-103 4 FOR \$1.00
100 FOR \$22.50

120V INDICATOR

NEON INDICATOR. RATED 120V 1/3W. MOUNTS IN 5/16" HOLE. RED LENS. 75¢ EACH
10 FOR \$7.00
100 FOR \$65.00

0-15 VDC METER

THIS 2 1/4" SQUARE METER MEASURES 0-15 VDC. \$4.50 EACH

COMPUTER GRADE CAPACITOR

1700 mfd. 150VDC \$2.00
2 1/2" DIA X 4 3/4" HIGH
3,600 mfd. 40VDC \$1.00
1 3/8" DIA. X 3" HI
6,400 mfd. 60VDC \$2.50
1 3/8" DIA X 4 1/4"
12,000 mfd. 40 VDC \$3.00
2" DIA X 4 1/4" HIGH
18,000 mfd. 75 VDC \$4.00
2 1/2" DIA X 4 1/2" HIGH
22,000 mfd. 15VDC 2" DIA X 2 1/2" HIGH \$2.00
22,000 mfd. 40VDC 2" DIA. X 6" HIGH \$3.00
24,000 mfd. 30 VDC 1 3/4" DIA X 4" HI \$3.50
31,000 mfd. 15 VDC 1 3/4" DIA X 4" HI \$2.50
72,000 mfd. 15 VDC 2" DIA. X 4" HIGH \$3.50

COMPUTER GRADE CAPACITOR SPECIAL
180,000 mfd. at 6V
2 1/2" DIA X 4 1/2" HIGH \$1.50
CLAMPS TO FIT CAPACITORS 50¢ ea

DC WALL TRANSFORMER
ALL ARE 115 VAC PLUG IN

4 VDC at 70 MA \$2.50
9 VDC at 100 MA \$2.00
9 VDC at 225 MA \$3.00
16.5 VAC 10 VA \$3.50
22 VDC at 60 MA \$2.50

TRANSFORMERS

120 volt primaries

5.6 VOLTS at 750 MA \$3.00
6 VOLTS at 150 MA \$1.25
16.5 V. at 3 AMPS \$6.50
18 VOLTS at 1 AMP \$4.50
18 VCT. at 2 AMP \$5.50
24 VOLTS at 250 ma \$2.50
24 VCT at 1 AMP \$4.50
42 VCT. at 1.2 AMP \$4.50
65 VCT. at 2 AMP \$5.50

L.E.D.'s

STANDARD JUMBO DIFFUSED
RED 10 FOR \$1.50
GREEN 10 FOR \$2.00
YELLOW 10 FOR \$2.00
FLASHER LED
5 VOLT OPERATION
RED JUMBO SIZE \$1.00 EACH
BI POLAR LED 2 FOR \$1.70
SUB MINI LED RED .079" X .098" 10 FOR \$1.00
20 mA at 1.75V 200 FOR \$18.00

LED HOLDERS
TWO PIECE HOLDER FOR JUMBO LED 10 FOR 65¢ 200 FOR \$10.00

CRYSTALS
CASE STYLE HC33/U
2 MHZ: COLORBURST 3579, 545 KC \$3.50 EACH \$1.00 EACH

FREE! SEND FOR OUR NEW 1983 40 PAGE CATALOG FREE!

MINIATURE 6VDC RELAY

SUPER SMALL SPDT RELAY; GOLD COBALT CONTACTS. RATED 1 AMP AT 30 VDC; HIGHLY SENSITIVE, TTL DIRECT DRIVE POSSIBLE, OPERATES FROM 4.3 TO 6 V; COIL RES. 220 OHM. 1 3/16" X 13/32" X 7/16" ARMAZ # RSD-6V \$1.50 EACH 10 FOR \$13.50

4PDT RELAY

14 pin style
3 amp contacts
24 volt d.c. or 120 volt a.c. coil
Used but fully tested \$1.70 EACH
specify coil voltage
LARGE QUANTITIES AVAILABLE
SOCKETS FOR RELAY 50¢ each

4 WATT STEREO AMP

ASSEMBLY INCLUDES VOLUME, BALANCE AND TONE CONTROLS, CERAMIC PHONE INPUT, LINE INPUT AND 8 OHM OUTPUT FOR SPEAKER OR HEADPHONES. OPERATES ON 12 VAC @ 500MA. OUR ABOVE 12 VOLT TRANSFORMER IS IDEAL FOR THIS APPLICATION \$4.50 EACH

EDGE CONNECTOR

ALL ARE .156" SPACING
15 PIN GOLD SOLDER EYELET \$1.75 EACH
15/30 GOLD SOLDER EYELET \$2.00 EACH
18/36 GOLD SOLDER EYELET \$2.00 EACH
22/44 GOLD SOLDER TAIL (P.C. STYLE) \$2.50 EA 10 FOR \$22.50
22/44 GOLD SOLDER EYELET \$2.50 EACH

6 VDC RELAY

MINIATURE D.P.D.T.
3 AMP CONTACTS
FUJITSU # FBR321D006 \$1.75 EA 10 / 16.00

13 VDC RELAY

CONTACT: S.P.N.C.
10 AMP @ 120 VAC
ENERGIZE COIL TO OPEN CONTACT...
COIL: 13 VDC 650 OHMS
SPECIAL PRICE \$1.00 EACH

MINI-PUSH BUTTON

S.P.S.T. MOMENTARY NORMALLY OPEN 1/4" BUSHING 35¢ EACH 10 FOR \$3.25 100 FOR \$30.00
SPECIFY COLOR: RED, BLACK, WHITE, GREEN, YELLOW.

KEY SWITCH

S.P.S.T. 4 AMPS @ 125 VAC KEY REMOVES BOTH POSITIONS \$3.50 EA

LIGHTED PUSH BUTTON

RED LIGHTED 120 VAC 10 AMP. S.P.S.T. "POWER" PRINTED ON FACE. MOUNTS IN 7/8" SQUARE HOLE. \$1.50 EA 10 / \$13.50

2 CHANNEL LIGHT ORGAN

EASILY HOOKS INTO STEREO SPEAKERS AND ALLOWS 110 VAC LIGHTS TO DANCE WITH MUSIC. TWO SEPARATE 110 VAC OUTPUTS FOR HIGH AND LOW FREQUENCY AUDIO SIGNALS. USE TWO ORGANS FOR STEREO... \$6.50 PER UNIT
COLOR LIGHT STRING AVAILABLE \$1.75 EA

FOOT CONTROL WITH SIDE SWITCH

MEASURES 4 3/4" X 9 3/4" WITH 100 K LINEAR POT AND MOMENTARY S.P.D.T. SWITCH. \$6.50 EACH

BLACK LIGHT (ULTRAVIOLET)

G.E. # F6T5BL \$2.50 each

AM/FM/MPX CHASSIS

THIS AM / FM / STEREO CHASSIS IS COMPLETE AND READY TO PLUG IN EXCEPT FOR THE SPEAKERS... HAS CONNECTIONS FOR UP TO 4 SPEAKERS, A TURNABLE, RECORDING OUTPUT AND HEADPHONES. IDEAL FOR MOUNTING INTO YOUR CUSTOM CABINET... \$12.50 EACH

SLIDE POTS

500K linear taper 2 7/8" LG. 75¢ EACH
1 3/4" TRAVEL
DUAL 100 K AUDIO TAPER SLIDEPOT
3 1/2" LONG 2 1/2" TRAVEL. \$1.50 EACH

KEYBOARD w/ case

16 KEY KEYBOARD MATRIX ENCODED
TERMINATES TO FLEXIBLE CABLE WITH CONTACTS ON .100 CENTERS. EDGE CONNECTOR INCLUDED... \$4.50 PER KEYBOARD, CASE, AND CONNECTOR.....

EQUIPMENT SLIDES

CHASSIS-TRAK MODEL C3005
3 SECTION. LENGTH 22" CLOSED.
HOLDS TO 85 LBS., EXTENDS 23"
\$5.00 PER PAIR SOME HARDWARE INCLUDED

METAL OXIDE VARISTOR

G.E. # V82A12
50 VOLTS, NOMINAL D.C. VOLTAGE. 5/8" DIAMETER. 2 FOR \$1.50

ALL ELECTRONICS CORP.
TOLL FREE ORDERS ONLY 1-800-826-5432 (ORDER ONLY)
ALASKA, HAWAII, CALIF OR INFORMATION (213) 380-8000
905 S. Vermont Ave. P.O. BOX 20406 Los Angeles, Calif. 90006

CABLE TV

CONVERTERS DESCRABLERS

Largest Selection of Equipment Available
\$ Buy Warehouse Direct & Save \$



36 channel converter \$45.95

36 channel wired remote converter only \$88.95



Send \$2 for complete catalog of converters and unscramblers

Quantity Discounts • Visa • Master Charge
Add 5% shipping—Mich. residents add 4% sales tax

C&D Electronics, Inc.
P.O. Box 21, Jenison, MI 49428
(616) 669-2440

Burglar/Fire Alarms

FREE CATALOG

over 2000 products

CCTV controls alarm systems passive infra reds motion detectors ultrasonic detectors magnetic contacts smoke detectors vehicle alarms accessories remotes tools

mountain west™
425 N. 16th Street Dept. RE-3
Phoenix, AZ 85016
1-800-528-6169 toll-free

ramsey the first name in Counters!



9 DIGITS 600 MHz \$129⁹⁵ WIRED

PRICES:

| | |
|--------------------------------------|----------|
| CT-90 wired, 1 year warranty | \$129.95 |
| CT-90 Kit, 90 day parts warranty | 109.95 |
| AC-1 AC adapter | 3.95 |
| BP-1 Nicad pack + AC Adapter/Charger | 12.95 |
| OV-1, Micro power Oven time base | 49.95 |
| External time base input | 14.95 |

The CT-90 is the most versatile, feature packed counter available for less than \$300.00! Advanced design features include: three selectable gate times, nine digits, gate indicator and a unique display hold function which holds the displayed count after the input signal is removed! Also, a 10MHz TCXO time base is used which enables easy zero beat calibration checks against WWV. Optionally, an internal nicad battery pack, external time base input and Micro-power high stability crystal oven time base are available. The CT-90, performance you can count on!

SPECIFICATIONS:

| | |
|--------------|--|
| Range: | 20 Hz to 600 MHz |
| Sensitivity: | Less than 10 MV to 150 MHz Less than 50 MV to 500 MHz |
| Resolution: | 0.1 Hz (10 MHz range) 1.0 Hz (60 MHz range) 10.0 Hz (600 MHz range) |
| Display: | 9 digits 0.4" LED |
| Time base: | Standard-10.000 mHz, 1.0 ppm 20-40°C. Optional Micro-power oven-0.1 ppm 20-40°C |
| Power: | 8-15 VAC @ 250 ma |

7 DIGITS 525 MHz \$99⁹⁵ WIRED



SPECIFICATIONS:

| | |
|--------------|--|
| Range: | 20 Hz to 525 MHz |
| Sensitivity: | Less than 50 MV to 150 MHz Less than 150 MV to 500 MHz |
| Resolution: | 1.0 Hz (5 MHz range) 10.0 Hz (50 MHz range) 100.0 Hz (500 MHz range) |
| Display: | 7 digits 0.4" LED |
| Time base: | 1.0 ppm TCXO 20-40°C |
| Power: | 12 VAC @ 250 ma |

The CT-70 breaks the price barrier on lab quality frequency counters. Deluxe features such as; three frequency ranges - each with pre-amplification, dual selectable gate times, and gate activity indication make measurements a snap. The wide frequency range enables you to accurately measure signals from audio thru UHF with 1.0 ppm accuracy - that's .0001%! The CT-70 is the answer to all your measurement needs, in the field, lab or ham shack.

PRICES:

| | |
|--------------------------------------|---------|
| CT-70 wired, 1 year warranty | \$99.95 |
| CT-70 Kit, 90 day parts warranty | 84.95 |
| AC-1 AC adapter | 3.95 |
| BP-1 Nicad pack + AC adapter/charger | 12.95 |

7 DIGITS 500 MHz \$79⁹⁵ WIRED



PRICES:

| | |
|--|---------|
| MINI-100 wired, 1 year warranty | \$79.95 |
| AC-Z Ac adapter for MINI-100 | 3.95 |
| BP-Z Nicad pack and AC adapter/charger | 12.95 |

Here's a handy, general purpose counter that provides most counter functions at an unbelievable price. The MINI-100 doesn't have the full frequency range or input impedance qualities found in higher price units, but for basic RF signal measurements, it can't be beat! Accurate measurements can be made from 1 MHz all the way up to 500 MHz with excellent sensitivity throughout the range, and the two gate times let you select the resolution desired. Add the nicad pack option and the MINI-100 makes an ideal addition to your tool box for "in-the-field" frequency checks and repairs.

SPECIFICATIONS:

| | |
|--------------|---|
| Range: | 1 MHz to 500 MHz |
| Sensitivity: | Less than 25 MV |
| Resolution: | 100 Hz (slow gate) 1.0 KHz (fast gate) |
| Display: | 7 digits, 0.4" LED |
| Time base: | 2.0 ppm 20-40°C |
| Power: | 5 VDC @ 200 ma |

8 DIGITS 600 MHz \$159⁹⁵ WIRED



**NEW
READ
RECEIVER
FREQUENCY**

SPECIFICATIONS:

| | |
|--------------|---|
| Range: | 20 Hz to 600 MHz |
| Sensitivity: | Less than 25 mv to 150 MHz Less than 150 mv to 600 MHz |
| Resolution: | 1.0 Hz (60 MHz range) 10.0 Hz (600 MHz range) |
| Display: | 8 digits 0.4" LED |
| Time base: | 2.0 ppm 20-40°C |
| Power: | 110 VAC or 12 VDC |

The CT-50 is a versatile lab bench counter that will measure up to 600 MHz with 8 digit precision. And, one of its best features is the Receive Frequency Adapter, which turns the CT-50 into a digital readout for any receiver. The adapter is easily programmed for any receiver and a simple connection to the receiver's VFO is all that is required for use. Adding the receiver adapter in no way limits the operation of the CT-50, the adapter can be conveniently switched on or off. The CT-50, a counter that can work double-duty!

PRICES:

| | |
|---|----------|
| CT-50 wired, 1 year warranty | \$159.95 |
| CT-50 Kit, 90 day parts warranty | 119.95 |
| RA-1, receiver adapter kit | 14.95 |
| RA-1 wired and pre-programmed (send copy of receiver schematic) | 29.95 |



DIGITAL MULTIMETER \$99⁹⁵ WIRED

PRICES:

| | |
|---------------------------------------|---------|
| DM-700 wired, 1 year warranty | \$99.95 |
| DM-700 Kit, 90 day parts warranty | 79.95 |
| AC-1, AC adaptor | 3.95 |
| BP-3, Nicad pack + AC adapter/charger | 19.95 |
| MP-1, Probe kit | 2.95 |

The DM-700 offers professional quality performance at a hobbyist price. Features include: 26 different ranges and 5 functions, all arranged in a convenient, easy to use format. Measurements are displayed on a large 3 1/2 digit, 1/2 inch LED readout with automatic decimal placement, automatic polarity, overrange indication and overload protection up to 1250 volts on all ranges, making it virtually goof-proof! The DM-700 looks great, a handsome, jet black, rugged ABS case with convenient retractable tilt bail makes it an ideal addition to any shop.

SPECIFICATIONS:

| | |
|------------------|----------------------------------|
| DC/AC volts: | 100uV to 1 KV, 5 ranges |
| DC/AC current: | 0.1uA to 2.0 Amps, 5 ranges |
| Resistance: | 0.1 ohms to 20 Megohms, 6 ranges |
| Input impedance: | 10 Megohms, DC/AC volts |
| Accuracy: | 0.1% basic DC volts |
| Power: | 4 °C cells |

AUDIO SCALER

For high resolution audio measurements, multiplies UP in frequency.

- Great for PL tones
- Multiplies by 10 or 100
- 0.01 Hz resolution!

\$29.95 Kit \$39.95 Wired

ACCESSORIES

| | |
|--|---------|
| Telescopic whip antenna - BNC plug | \$ 7.95 |
| High impedance probe, light loading | 15.95 |
| Low pass probe, for audio measurements | 15.95 |
| Direct probe, general purpose usage | 12.95 |
| Tilt bail, for CT 70, 90, MINI-100 | 3.95 |
| Color burst calibration unit, calibrates counter against color TV signal | 14.95 |

COUNTER PREAMP

For measuring extremely weak signals from 10 to 1,000 MHz. Small size, powered by plug transformer-included.

- Flat 25 db gain
- BNC Connectors
- Great for sniffing RF with pick-up loop

\$34.95 Kit \$44.95 Wired

ramsey electronics, inc.

2575 BAIRD RD. • PENFIELD, NY 14526



TERMS

Satisfaction guaranteed - examine for 10 days, if not pleased return in original form for refund. Add 5% for shipping - insurance to a maximum of \$10. Overseas add 15% COD, add \$2. Orders under \$10, add \$1.50. NY residents add 7% tax.

PHONE ORDERS
CALL 716-586-3950

CIRCLE 46 ON FREE INFORMATION CARD

MARCH 1983

125

**Number of Pins of each I.C. for easy Stock purchase.

MICROPROCESSOR COMPONENTS

Digitalker™

| Part No. | **Pins | Price |
|----------|--------|-------|
| SN7400N | 14 | 19 |
| SN7401N | 14 | 19 |
| SN7402N | 14 | 19 |
| SN7403N | 14 | 25 |
| SN7404N | 14 | 25 |
| SN7405N | 14 | 25 |
| SN7406N | 14 | 25 |
| SN7407N | 14 | 29 |
| SN7408N | 14 | 29 |
| SN7409N | 14 | 29 |
| SN7410N | 14 | 25 |
| SN7411N | 14 | 25 |
| SN7412N | 14 | 25 |
| SN7413N | 14 | 25 |
| SN7414N | 14 | 25 |
| SN7415N | 14 | 25 |
| SN7416N | 14 | 25 |
| SN7417N | 14 | 25 |
| SN7418N | 14 | 25 |
| SN7419N | 14 | 25 |
| SN7420N | 14 | 25 |
| SN7421N | 14 | 25 |
| SN7422N | 14 | 25 |
| SN7423N | 14 | 25 |
| SN7424N | 14 | 25 |
| SN7425N | 14 | 25 |
| SN7426N | 14 | 25 |
| SN7427N | 14 | 25 |
| SN7428N | 14 | 25 |
| SN7429N | 14 | 25 |
| SN7430N | 14 | 25 |
| SN7431N | 14 | 25 |
| SN7432N | 14 | 25 |
| SN7433N | 14 | 25 |
| SN7434N | 14 | 25 |
| SN7435N | 14 | 25 |
| SN7436N | 14 | 25 |
| SN7437N | 14 | 25 |
| SN7438N | 14 | 25 |
| SN7439N | 14 | 25 |
| SN7440N | 14 | 25 |
| SN7441N | 14 | 25 |
| SN7442N | 14 | 25 |
| SN7443N | 14 | 25 |
| SN7444N | 14 | 25 |
| SN7445N | 14 | 25 |
| SN7446N | 14 | 25 |
| SN7447N | 14 | 25 |
| SN7448N | 14 | 25 |
| SN7449N | 14 | 25 |
| SN7450N | 14 | 25 |
| SN7451N | 14 | 25 |
| SN7452N | 14 | 25 |
| SN7453N | 14 | 25 |
| SN7454N | 14 | 25 |
| SN7455N | 14 | 25 |
| SN7456N | 14 | 25 |
| SN7457N | 14 | 25 |
| SN7458N | 14 | 25 |
| SN7459N | 14 | 25 |
| SN7460N | 14 | 25 |
| SN7461N | 14 | 25 |
| SN7462N | 14 | 25 |
| SN7463N | 14 | 25 |
| SN7464N | 14 | 25 |
| SN7465N | 14 | 25 |
| SN7466N | 14 | 25 |
| SN7467N | 14 | 25 |
| SN7468N | 14 | 25 |
| SN7469N | 14 | 25 |
| SN7470N | 14 | 25 |
| SN7471N | 14 | 25 |
| SN7472N | 14 | 25 |
| SN7473N | 14 | 25 |
| SN7474N | 14 | 25 |
| SN7475N | 14 | 25 |
| SN7476N | 14 | 25 |
| SN7477N | 14 | 25 |
| SN7478N | 14 | 25 |
| SN7479N | 14 | 25 |
| SN7480N | 14 | 25 |
| SN7481N | 14 | 25 |
| SN7482N | 14 | 25 |
| SN7483N | 14 | 25 |
| SN7484N | 14 | 25 |
| SN7485N | 14 | 25 |
| SN7486N | 14 | 25 |
| SN7487N | 14 | 25 |
| SN7488N | 14 | 25 |
| SN7489N | 14 | 25 |
| SN7490N | 14 | 25 |
| SN7491N | 14 | 25 |
| SN7492N | 14 | 25 |
| SN7493N | 14 | 25 |
| SN7494N | 14 | 25 |
| SN7495N | 14 | 25 |
| SN7496N | 14 | 25 |
| SN7497N | 14 | 25 |
| SN7498N | 14 | 25 |
| SN7499N | 14 | 25 |
| SN7500N | 14 | 25 |

| Part No. | **Pins | Price |
|----------|--------|-------|
| SN7472N | 14 | 23 |
| SN7473N | 14 | 35 |
| SN7474N | 14 | 35 |
| SN7475N | 14 | 35 |
| SN7476N | 14 | 35 |
| SN7477N | 14 | 4.95 |
| SN7478N | 14 | 69 |
| SN7479N | 14 | 69 |
| SN7480N | 14 | 69 |
| SN7481N | 14 | 1.19 |
| SN7482N | 14 | 1.19 |
| SN7483N | 14 | 1.19 |
| SN7484N | 14 | 1.19 |
| SN7485N | 14 | 1.19 |
| SN7486N | 14 | 1.19 |
| SN7487N | 14 | 1.19 |
| SN7488N | 14 | 1.19 |
| SN7489N | 14 | 1.19 |
| SN7490N | 14 | 1.19 |
| SN7491N | 14 | 1.19 |
| SN7492N | 14 | 1.19 |
| SN7493N | 14 | 1.19 |
| SN7494N | 14 | 1.19 |
| SN7495N | 14 | 1.19 |
| SN7496N | 14 | 1.19 |
| SN7497N | 14 | 1.19 |
| SN7498N | 14 | 1.19 |
| SN7499N | 14 | 1.19 |
| SN7500N | 14 | 1.19 |

| Part No. | **Pins | Price |
|----------|--------|-------|
| SN7456N | 16 | 39 |
| SN7457N | 16 | 69 |
| SN7458N | 16 | 69 |
| SN7459N | 16 | 69 |
| SN7460N | 16 | 69 |
| SN7461N | 16 | 69 |
| SN7462N | 16 | 69 |
| SN7463N | 16 | 69 |
| SN7464N | 16 | 69 |
| SN7465N | 16 | 69 |
| SN7466N | 16 | 69 |
| SN7467N | 16 | 69 |
| SN7468N | 16 | 69 |
| SN7469N | 16 | 69 |
| SN7470N | 16 | 69 |
| SN7471N | 16 | 69 |
| SN7472N | 16 | 69 |
| SN7473N | 16 | 69 |
| SN7474N | 16 | 69 |
| SN7475N | 16 | 69 |
| SN7476N | 16 | 69 |
| SN7477N | 16 | 69 |
| SN7478N | 16 | 69 |
| SN7479N | 16 | 69 |
| SN7480N | 16 | 69 |
| SN7481N | 16 | 69 |
| SN7482N | 16 | 69 |
| SN7483N | 16 | 69 |
| SN7484N | 16 | 69 |
| SN7485N | 16 | 69 |
| SN7486N | 16 | 69 |
| SN7487N | 16 | 69 |
| SN7488N | 16 | 69 |
| SN7489N | 16 | 69 |
| SN7490N | 16 | 69 |
| SN7491N | 16 | 69 |
| SN7492N | 16 | 69 |
| SN7493N | 16 | 69 |
| SN7494N | 16 | 69 |
| SN7495N | 16 | 69 |
| SN7496N | 16 | 69 |
| SN7497N | 16 | 69 |
| SN7498N | 16 | 69 |
| SN7499N | 16 | 69 |
| SN7500N | 16 | 69 |

| Part No. | **Pins | Price |
|----------|--------|-------|
| SN7456N | 16 | 39 |
| SN7457N | 16 | 69 |
| SN7458N | 16 | 69 |
| SN7459N | 16 | 69 |
| SN7460N | 16 | 69 |
| SN7461N | 16 | 69 |
| SN7462N | 16 | 69 |
| SN7463N | 16 | 69 |
| SN7464N | 16 | 69 |
| SN7465N | 16 | 69 |
| SN7466N | 16 | 69 |
| SN7467N | 16 | 69 |
| SN7468N | 16 | 69 |
| SN7469N | 16 | 69 |
| SN7470N | 16 | 69 |
| SN7471N | 16 | 69 |
| SN7472N | 16 | 69 |
| SN7473N | 16 | 69 |
| SN7474N | 16 | 69 |
| SN7475N | 16 | 69 |
| SN7476N | 16 | 69 |
| SN7477N | 16 | 69 |
| SN7478N | 16 | 69 |
| SN7479N | 16 | 69 |
| SN7480N | 16 | 69 |
| SN7481N | 16 | 69 |
| SN7482N | 16 | 69 |
| SN7483N | 16 | 69 |
| SN7484N | 16 | 69 |
| SN7485N | 16 | 69 |
| SN7486N | 16 | 69 |
| SN7487N | 16 | 69 |
| SN7488N | 16 | 69 |
| SN7489N | 16 | 69 |
| SN7490N | 16 | 69 |
| SN7491N | 16 | 69 |
| SN7492N | 16 | 69 |
| SN7493N | 16 | 69 |
| SN7494N | 16 | 69 |
| SN7495N | 16 | 69 |
| SN7496N | 16 | 69 |
| SN7497N | 16 | 69 |
| SN7498N | 16 | 69 |
| SN7499N | 16 | 69 |
| SN7500N | 16 | 69 |

| Part No. | **Pins | Price |
|----------|--------|-------|
| SN7456N | 16 | 39 |
| SN7457N | 16 | 69 |
| SN7458N | 16 | 69 |
| SN7459N | 16 | 69 |
| SN7460N | 16 | 69 |
| SN7461N | 16 | 69 |
| SN7462N | 16 | 69 |
| SN7463N | 16 | 69 |
| SN7464N | 16 | 69 |
| SN7465N | 16 | 69 |
| SN7466N | 16 | 69 |
| SN7467N | 16 | 69 |
| SN7468N | 16 | 69 |
| SN7469N | 16 | 69 |
| SN7470N | 16 | 69 |
| SN7471N | 16 | 69 |
| SN7472N | 16 | 69 |
| SN7473N | 16 | 69 |
| SN7474N | 16 | 69 |
| SN7475N | 16 | 69 |
| SN7476N | 16 | 69 |
| SN7477N | 16 | 69 |
| SN7478N | 16 | 69 |
| SN7479N | 16 | 69 |
| SN7480N | 16 | 69 |
| SN7481N | 16 | 69 |
| SN7482N | 16 | 69 |
| SN7483N | 16 | 69 |
| SN7484N | 16 | 69 |
| SN7485N | 16 | 69 |
| SN7486N | 16 | 69 |
| SN7487N | 16 | 69 |
| SN7488N | 16 | 69 |
| SN7489N | 16 | 69 |
| SN7490N | 16 | 69 |
| SN7491N | 16 | 69 |
| SN7492N | 16 | 69 |
| SN7493N | 16 | 69 |
| SN7494N | 16 | 69 |
| SN7495N | 16 | 69 |
| SN7496N | 16 | 69 |
| SN7497N | 16 | 69 |
| SN7498N | 16 | 69 |
| SN7499N | 16 | 69 |
| SN7500N | 16 | 69 |

DT1050 — Applications: Teaching aids, appliances, clocks, automotive, telecommunications, language translators, etc.

The DT1050 is a standard DIGITALKER kit encoded with 137 separate and useful words, 2 tones, and 5 different alert durations. The words and tones have been assigned discrete addresses, making it possible to output single words or words concatenated into phrases or sentences. The "voice" output of the DT1050 is a highly intelligible male voice. Female and children's voices can be synthesized. The vocabulary is chosen so that it is applicable to many practical markets.

The DT1050 consists of a Speech Processor Chip, MM54104 (40-pin) and a 2 (2) Speech ROMs MM521645SR1 and MM521645SR2 (24-pin) along with a Master Word list and a recommended schematic diagram on the application sheet.

DT1050 Digitalker™ \$34.95 ea.

DT1057 — Expands the DT1050 vocabulary from 137 to over 260 words. Incl. 2 ROMs and specs.

DT1057 \$24.95 ea.

RADIO CONTROL CIRCUITS

Ideal to use for:

- Toys, hobby crafts, robots, trains
- Burglar alarms + IR data links
- Remote slide projector controls
- Consumer remote data links
- Energy-saving, remotely switched lighting systems

A complete 6-channel digital encoder and RF transmitter; low power, at frequency of 27MHz or 49MHz; a field strength of 10,000uV/meter at 3 meters. 9V operation on chip RF oscillator/transmitter, on chip 4.8uA quiescent, up to 80MHz carrier frequency operation.

LM1871N RC Encoder/Transmitter Chip . . . \$1.95

A complete RF receiver/decoder, used with either 27MHz, 49MHz or 72MHz. It provides 4 independent channels when used with LM1871 (2 analog, 2 digital) operates from four 1.5V cells. Crystal controlled.

LM1872N RC Receiver/Decoder Chip . . . \$2.49

SRX1504 49.435MHz Crystal (LM1872N) . . . \$3.95

SRX1505 49.890MHz Crystal (LM1871N) . . . \$3.95

| Part No. | **Pins | Price |
|----------|--------|-------|
| SN7456N | 16 | 39 |
| SN7457N | 16 | 69 |
| SN7458N | 16 | 69 |
| SN7459N | 16 | 69 |
| SN7460N | 16 | 69 |
| SN7461N | 16 | 69 |
| SN7462N | 16 | 69 |
| SN7463N | 16 | 69 |
| SN7464N | 16 | 69 |
| SN7465N | 16 | 69 |
| SN7466N | 16 | 69 |
| SN7467N | 16 | 69 |
| SN7468N | 16 | 69 |
| SN7469N | 16 | 69 |
| SN7470N | 16 | 69 |
| SN7471N | 16 | 69 |
| SN7472N | 16 | 69 |
| SN7473N | 16 | 69 |
| SN7474N | 16 | 69 |
| SN7475N | 16 | 69 |
| SN7476N | 16 | 69 |
| SN7477N | 16 | 69 |
| SN7478N | 16 | 69 |
| SN7479N | 16 | 69 |
| SN7480N | 16 | 69 |
| SN7481N | 16 | 69 |
| SN7482N | 16 | 69 |
| SN7483N | 16 | 69 |
| SN7484N | 16 | 69 |
| SN7485N | 16 | 69 |
| SN7486N | 16 | 69 |
| SN7487N | 16 | 69 |
| SN7488N | 16 | 69 |
| SN7489N | 16 | 69 |
| SN7490N | 16 | 69 |
| SN7491N | 16 | 69 |
| SN7492N | 16 | 69 |
| SN7493N | 16 | 69 |
| SN7494N | 16 | 69 |
| SN7495N | 16 | 69 |
| SN7496N | 16 | 69 |
| SN7497N | 16 | 69 |
| SN7498N | 16 | 69 |
| SN7499N | 16 | 69 |
| SN7500N | 16 | 69 |

| Part No. | **Pins | Price |
|----------|--------|-------|
| SN7456N | 16 | 39 |
| SN7457N | 16 | 69 |
| SN7458N | 16 | 69 |
| SN7459N | 16 | 69 |
| SN7460N | 16 | 69 |
| SN7461N | 16 | 69 |
| SN7462N | 16 | 69 |
| SN7463N | 16 | 69 |
| SN7464N | 16 | 69 |
| SN7465N | 16 | 69 |
| SN7466N | 16 | 69 |
| SN7467N | 16 | 69 |
| SN7468N | 16 | 69 |
| SN7469N | 16 | 69 |
| SN7470N | 16 | 69 |
| SN7471N | 16 | 69 |
| SN7472N | 16 | 69 |
| SN7473N | 16 | 69 |
| SN7474N | 16 | 69 |
| SN7475N | 16 | 69 |
| SN7476N | 16 | 69 |
| SN7477N | 16 | 69 |
| SN7478N | 16 | 69 |
| SN7479N | 16 | 69 |
| SN7480N | 16 | 69 |
| SN7481N | 16 | 69 |
| SN7482N | 16 | 69 |
| SN7483N | 16 | 69 |
| SN7484N | 16 | 69 |
| SN7485N | 16 | 69 |
| SN7486N | 16 | 69 |
| SN7487N | 16 | 69 |
| SN7488N | 16 | 69 |
| SN7489N | 16 | 69 |
| SN7490N | 16 | 69 |
| SN7491N | 16 | 69 |
| SN7492N | 16 | 69 |
| SN7493N | 16 | 69 |
| SN7494N | 16 | 69 |
| SN7495N | 16 | 69 |
| SN7496N | 16 | 69 |
| SN7497N | 16 | 69 |
| SN7498N | 16 | 69 |
| SN7499N | 16 | 69 |
| SN7500N | 16 | 69 |

| Part No. | **Pins | Price |
|----------|--------|-------|
| SN7456N | 16 | 39 |
| SN7457N | 16 | 69 |

ATARI



JOYSTICKS
JSA (2) ... \$6.95/pair



PADDLES
JSP (2) ... \$4.95/pair



TV GAME SWITCH
Switches TV to video game or computer operation. Used on Atari.
TGS-1 ... \$2.95 ea.



VIDEO GAME CHIPS
Pull-outs from hand-held video games. AP2000 consists of one MM2716Q EPROM and one 74LS04. AP2002 consists of two MM2716 EPROMs and one 74LS04. These EPROMs are mounted on a circuit board with a 12-pin edge card connection. EPROMs can be reprogrammed for other applications.
AP2000 ... \$2.49 ea. or 2 for \$3.95
AP2002 ... \$3.49 ea. or 2 for \$6.49



JOYSTICKS
JS-5K 5K Linear Taper Pats \$5.25
JS-100K 100K Linear Taper Pats \$4.95
JS-150K 150K Linear Taper Pats \$4.75
JVC-40 40K (2) Video Controller in Case \$4.95
JS KNOB Knob for JS5K,100K,150K \$9.99 ea.
JVC KNOB Knob for JVC-40 \$9.99 ea.



Digital Thermometer Kit
Dual sensors - switch controls for indoor/outdoor or dual monitoring - can be extended to 500 feet. Continuous LED 8" ht. display. Range: -40°F to 199°F. -40°C to 100°C. Accuracy ±1° nominal. Calibrate for Fahrenheit or Celsius. Simulated walnut case. AC wall adapter included. Size: 6" L x 3 1/2" H x 1 1/2" D.
JE300 ... \$39.95

BOOKS

NATIONAL SEMICONDUCTOR - INTERSIL - INTEL

| | | |
|-------|---|---------|
| 30001 | National CMOS Data Book (1981) (840 pages) 74C, CD4000, and A/D Converters | \$8.95 |
| 30002 | National Interface Data Book (1980) (704 pages) DP, DS8000, DS3600, DS5700, etc. | \$6.95 |
| 30003 | National Linear Data Book (1982) (1376 pages) LM, LP, A/D, DAC, LH Series | \$11.95 |
| 30004 | National Series 80 - Board Level Computer (1980) (224 pages) | \$4.95 |
| 30005 | National TTL Logic Data Book (1981) (624 pages) 7400, LS, L.H.S., and DM8000 Series | \$9.95 |

30006 Above (3) 30001,3,5 as set \$24.95

| | | |
|--------|--|---------|
| 30008 | National Memory Data Book (1980) (464 pages) LAMs, ROMs, PROMs, EPROMs Series | \$6.95 |
| 30009 | Interall Data Book (1983) (1356 pages) Complete line | \$9.95 |
| 30010 | National Audio/Radio Handbook (1980) (240 pages) Pre-Amps, AM, FM & FM Stereo, Power Amps | \$5.95 |
| 30011 | National Linear Application Handbook (1980) (736 pages) Application Notes, Linear Briefs, etc. | \$15.95 |
| 30012 | National PAL Data Book (1982) (176 pages) Data Sheet, PAL Design | \$5.95 |
| 30013 | Zilog Data Book (1983) (641 pages) Microprocessors and Support Chips | \$7.95 |
| 010400 | Intel Component Data Book (1982) (1405 pg) Full data sheets for Intel's products incl. mem. devices, microproc, periph. & ind./mil. products | \$14.95 |
| 205610 | Intel Peripheral Design Handbook (1981) (828 pages) Full data sheets, application notes for Intel peripheral device components | \$9.95 |



Computer Keyboard Enclosures
"DTE" Blank Desk-Top Enclosures are designed for easy modification. High strength epoxy molded end pieces in mocha brown finish. Sliding rear/bottom panel for service/component access. Top/bottom panels: 0.80" thick alum. anodized type 1200 finish (gold tint color) for best paint adhesion after modification. Vented top & bottom panels for cooling efficiency. Rigid construction provides unlimited applications. Assembly instructions included.

| | | |
|---------|------------------------|--------|
| BTH-001 | Horizontal Bug Tray | \$4.95 |
| BTV-001 | Vertical Bug Tray | 1.95 |
| BTP-001 | Open Bug Tray | 1.95 |
| BTX-003 | 1 of each Bug Tray (3) | 4.98 |

BUG RUG™ - Static discharge protection for CMOS and MOSFET devices. Pre-cut to dimensions of BUG BOX (1" x 3 1/2").

| | | |
|---------|---------------------------------|--------|
| BRG-030 | 30 foam rectangles for Bug Box | \$1.98 |
| BRR-036 | 6 foam rec. for LSI Big Bug Box | 1.98 |

CAGE KEEPER™ - Pins column of Bug Boxes in Bug Cage

| | | |
|---------|---------|-------------|
| CKP-005 | 5 inch | \$4.99/pkg. |
| CKP-010 | 10 inch | 6.99/pkg. |



Mostek DC/DC Converter
+5 VOLTS TO -9 VOLTS
Input: +5V. Output: -9V (regulated) @ 30mA. Printed circuit mounting. Specifications incl. DC10 ... \$2.95 ea. or 2/\$4.95



Battery Checker
Easy-to-use hand-held battery checker tests AA, AAA, C, D, and 216 batteries. A multi-colored meter shows if battery is good, weak or needs replacing. Size: 6 1/4" L x 2 1/4" W x 1-7/8" H.
BC-1 ... \$6.95 ea.

KEYBOARDS - POWER SUPPLIES

| | |
|--|---|
| | DATANETICS 73-KEY KEYBOARD Data Entry Keyboard. Includes IBM/XT encoder chip (included). 73-Key Keyboard features 11-key numeric keypad, SPST switching, 24-pin edge card connection. Includes pin-out. Part No. KB261 (Fits DTE-20 Enclosure) ... \$49.95 each |
| | MICRO SWITCH 69-KEY KEYBOARD Data Entry Keyboard. Extended Output. Parallel EBC DIC. Switching. Half Effect. 24-pin Edge Card Connection. Complete w/ Pin Connection. Can easily be modified to ASCII code. Part No. KB69SD12-2 (Fits into DTE-20 Enclosure) ... \$19.95 each |
| | MICRO SWITCH 85-KEY KEYBOARD Word Processing Keyboard. 26 Pin Edge Card Connection. Supply Voltage +5VDC. Main Keyboard is QWERTY. Additional Key Pads for Cursor and word processing functions. Part No. 85SD18-1 ... \$29.95 each |
| | MICRO SWITCH 88-KEY KEYBOARD (PARALLEL) Data Entry Keyboard used in a Diablo 1640 Terminal. Supply Voltage: +5V. -12V. Switching: Half Effect. 16-pin Edge Card Connection. Schematic included. Uses 8048 Encoder Chip. Part No. 88SD22 (Fits into DTE-20 Enclosure) ... \$49.95 each |
| | HI-TEK 58-KEY KEYBOARD SPST switching, mechanical, monolithic housing, charcoal gray keypad. Keyboard is not mounted on circuit board (each key is individually accessible). Used to replace touch-membrane found on Sinclair, Atari, and TRS-80 Computers. Part No. K-58 (Fits DTE-14 Enclosure) ... \$19.95 each |
| | ALPS 29-KEY CALCULATOR KEYBOARD Features one 3-position decimal select switch, one 3-position switch, and two 2-position switches. Mechanical SPST switching. 22-pin edge card connection. Pin-out included. Part No. KB29TD40 (Fits DTE-11 Enclosure) ... \$4.95 each |
| | POWER SUPPLY +5VDC @ 1 AMP REGULATED Output: +5VDC @ 1A (also +30VDC) reg. Input: 115VAC 50/60Hz. 1-line (black/white) self-enclosed. Mechanical SPST switching. 22-pin edge card connection. Pin-out included. Part No. PS51194 ... \$19.95 each |
| | POWER SUPPLY +5VDC @ 3 AMP REGULATED Input: 115VAC, 47-440Hz. Output: 5VDC Adjustable @ 3 amp, 5VDC @ 2.5 amp. Adjustable current limit. Ripple & Noise: 18V rms. 5MV p-p - 2 mounting surfaces. UL recognized. Size: 4" W x 1 1/2" D x 3 1/2" H. Wt. 5 lbs. Data sheet included. Part No. QPS-1 ... \$29.95 each |
| | POWER SUPPLY +5VDC @ 7.5 AMP, 12VDC @ 1.5 AMP SWITCHING Input: 115VAC, 50-60Hz. Output: 5VDC @ 7.5 amp, 12VDC @ 1.5 amp. Fan volt./power supply select switch (115/230VAC). Output: 5VDC @ 7.5 amp, 12VDC @ 1.5 amp. Fan bl. pow. cord. 11 1/2" W x 1 1/2" D x 3 1/2" H. Wt. 5 lbs. Part No. PS94V0 ... \$49.95 each |
| | POWER SUPPLY 4-Channel Switching Power Supply Microprocessor, mini-computer, terminal, medical equipment and process control applications. Input: 90-130VAC 47-440Hz. Output: +5VDC @ 5A, -5VDC @ 1A, +12VDC @ 1A, -12VDC @ 1A. Line reg. ±0.2%. Ripple: 20mV p-p. Load reg. ±1%. Overcurrent protection. A9 5 pin out. Size: 6.3" L x 7.7" W x 4.1" H. Wt. 1.1 lbs. Data sheet included. Part No. FCS-604A ... \$69.95 each |
| | POWER SUPPLY Adjustable Switching 4-24VDC to 5 Amps A4. 4-24VDC, 5VDC @ 5A, 5VDC @ 4.8A, 5VDC @ 4.1A, 12VDC @ 3.3A, 18VDC @ 1.9A, 24VDC @ 1.5A. Overvoltage Protection. Input: 115VAC 50/60Hz. Output variations within 20mV. 8.25" L x 4.25" W x 2.25" H. Wt. 3.25 lbs. JE224 Kit JE224A Assembled & Tested ... \$99.95 each |

| | | | | |
|--|--|--|--|--|
| | 84-Key Keyboard CA153A ... \$69.95 | CONTROL DATA Data Entry Keyboards RS232C Interface FT2 Shielded Base SPST Switching Monetary Contact Keyswitches 30" Interface Cable Attractive Case | | 104-Key Keyboard CA148 ... \$99.95 |
| | 95-Key Keyboard CA154A ... \$79.95 | | 80-Key Keyboard CA150C ... \$89.95 | |

Color; keycaps: black, blue, red - cover: black w/beige base. 2 1/4" x 9 1/2" x 3 1/2". 6 lbs.

BUG BOX™ - 30 individual compartments
• Stores 60 8-pin or 30 14- or 16-pin DIPs • Bug rug not included • Clear plastic cover slides & locks • Cover marked with numbers 1-30 • Compartment size: 1" x 3 7/8" x 5" deep • Box size: 4 9/8" x 3 3/8" x 6" • Weight: 1.75 oz.

BUG BOX™
Please specify color code: (B) Blue, (R) Red, (W) White, (Y) Yellow
Part No./Color Code

| | | |
|--------------|-----|--------|
| BGX-001- (B) | QTY | PRICE |
| BGX-010- (W) | 1 | \$2.29 |
| BGX-010- (Y) | 1 | 10.99 |

ANTI-STATIC

| | | |
|-----------------|-----|--------|
| BGX-001- (B) AS | QTY | PRICE |
| BGX-001- (Y) AS | 1 | \$3.29 |
| BGX-001- (W) AS | 1 | 20.99 |

BUG CAGETM - 12 locations store Bug Boxes, Big Bug Boxes or Bug Trays (Module) and interlocking • Heavy duty injection molded plastic • Each cage has 6 slip-on locations • 2 cages per pkg. • Cage size: 5-1/8" x 3-7/8" x 4 corners available - please specify color code: (B) Blue, (R) Red, (W) White, (Y) Yellow
Part No./Color Code

| | |
|---------------------------------|--------------|
| BGC-001- (2 Cages (8 loc. ea.)) | Price |
| BGC-001- (2 Cages (8 loc. ea.)) | \$11.95/pkg. |

BUG TRAY™ - Stores in Bug Cage • Molded plastic • Three styles: Open (1 compartment 3.05" x 4.6" x 6"), Vertical (5 compartments 5" x 4.6" x 6"), and Horizontal (8 compartments 4" x 3.95" x 6") • Ideal for tools, hardware, components, etc. • Tray size: 3.55" x 5.05" x 8" • Black color only
Part No. Description Price

BUG RUG™ - Static discharge protection for CMOS and MOSFET devices. Pre-cut to dimensions of BUG BOX (1" x 3 1/2").

| | | |
|---------|---------------------------------|--------|
| BRG-030 | 30 foam rectangles for Bug Box | \$1.98 |
| BRR-036 | 6 foam rec. for LSI Big Bug Box | 1.98 |

CAGE KEEPER™ - Pins column of Bug Boxes in Bug Cage

| | | |
|---------|---------|-------------|
| CKP-005 | 5 inch | \$4.99/pkg. |
| CKP-010 | 10 inch | 6.99/pkg. |

*** **BUG BOX SYSTEMS INTRODUCTORY SPECIAL** ***
Your choice: regular or anti-static. Includes 2-Bug Cages (12 locations); 8-Bug Boxes; 3-LSI Big Bug Boxes; 1-Horizontal Bug Tray; 1-Open Bug Tray; 1-Vertical Bug Tray; 1 package Bug Rug for regular Bug Boxes; 1 package Bug Rug for LSI Big Bug Boxes; 1 package Inter. Labels (800 each). Color: Bug Boxes and Cages - Blue; Bug Tray - Black.
SP-BUG Regular (Retail value \$59.45) ... Sale Price \$49.95
SP-BUG-AS Anti-Static (Retail value \$87.45) ... Sale Price \$59.95

\$10.00 Minimum Order - U.S. Funds Only
California Residents Add 6 1/2% Sales Tax
Shipping - Add 5% plus \$1.50 Insurance
Send S.A.S.E. for Monthly Sales Flyers!

Send Sheets - 30¢ each
Special \$1.00 Postage for your
FREE 1983 JAMECO CATALOG
Prices Subject to Change

Call for Quantity Discounts

Mail Order Electronics-Worldwide

Jameco ELECTRONICS

1355 SHOREWAY ROAD, BELMONT, CA 94002
3183 PHONE ORDERS WELCOME - (415) 592-8097 Telex: 176043

EXPAND YOUR MEMORY

TRS-80 to 16K, 32K, or 48K
**Model 1 = From 4K to 16K Requires (1) One Kit
Model 3 = From 4K to 48K Requires (3) Three Kits
Color = From 4K to 16K Requires (1) One Kit
**Model 1 equipped with Expansion Board up to 48K Two Kits Required - One Kit Required for each 16K of Expansion -

TRS-16Kx200ns for Color & Model III ... \$12.95
TRS-16Kx250ns for Model I ... \$10.95

TRS-80 Color 32K or 64K Conversion Kit
Kit comes complete with 8 each 4164-2 (200ns) 64K dynamic RAMs and conversion documentation. Converts TRS-80 color computers with D and E circuit boards, and all new color computers to 32K. Minor modifications of 32K memory will allow the use of all 64K of the dynamic RAM.
TRS-64K2 ... \$54.95

5 1/4" Mini-Floppy Disk Drive
FOR TRS-80 MODEL I (Industry Standard)
Features single or double density. Recording mode: FM single, MFM double density. Power: +12VDC (1.0A) 1.6A max., +5VDC (0.25A) 0.8A max. Unit as pic. at left (does not incl. case, power supply, cables). 30-pg. data book incl. Wt. 1 1/2 lbs. Size: 5 1/4" x 8 1/2" x 3 1/2".
Part No. Limited Quantity Price
FD200 Single-sided, 40 tracks, 250K bytes capacity \$179.95
FD250 Double-sided, 35 tracks, 488K bytes capacity \$199.95

8" Floppy Disk Drive
• Shugart 801R compatible
• Single-Sided
• 77 Tracks
• 400/800K Bytes Capacity
• Industry Standard

The FDD100-8" Floppy Disk Drive (Industry Standard) features single or double density. Recording mode: FM single, MFM double density. Transfer rate: 250K bits/sec. single density; 500K bits/sec. double density. The FDD100-8" is designed to work with the single-sided soft sector IBM Diskette I, or soft disk cartridge. Hard sector option available. Power: 115/230VAC @ 50/60Hz. +24VDC @ 1.7 amps max., +5VDC @ 1.2 amps max. Unit as pictured above (does not include case, power supply, or cables). Size: 8 1/2" W x 14 1/4" H. Weighs 12 lbs. Incl. 95-pg. manual.
Part No. Price
FDD100-8 Buy 1 for ... \$269.95 each
FDD100-8 Buy 2 for ... \$259.95 each
FDD100-8 Buy 10 for ... \$249.95 each

2708, 2716, 2732 & 2764 EPROM Programmer
JE664 EPROM PROGRAMMER
8K TO 64K EPROMS - 24 AND 28 PIN PACKAGES
Self-Contained - Requires No Additional Systems for Operation

NEW!

• Programs, validates, and checks for properly erased EPROMs • Emulates PROMs or EPROMs • RS232C Computer Interface for editing/program loading • Loads data into RAM by keyboard • Changes data in RAM by keyboard • Loads RAM from EPROM • Compares EPROMs for content differences • Copies EPROMs • Power Input: 115VAC, 50Hz, +12V power consumption • Enclosure: Color-coordinated, built-in panels w/rotated mocha brown and pieces • Size: 15.8" (H) x 9.4" (D) x 3 1/4" (W) • Wt.: 5 1/2 lbs.

JE664-A EPROM Programmer ... \$995.00
Assembled & Tested (includes JM16A Module)

JE665 - RS232C INTERFACE OPTION - The JE665 RS232C Interface Card provides computer access to the JE664 A RAM. Sample software written in BASIC provided for TRS-80 Model I Level II Computer. Base rate: 9600. Word Length: 8 bits - odd parity. Stop bits: 2. Option may be adapted to other computers.

JE664-ARS EPROM Prog. w/ JE665 Option ... \$1195.00
Assembled & Tested (includes JM16A Module)

EPROM JUMPER MODULES - The JE664 JUMPER MODULE (Personality Module) is a plug-in Module that pre-sets JE664 for proper programming rates to the EPROM & configures EPROM socket connections for that particular EPROM.

| Part No. | EPROM | EPROM MANUFACTURER | PRICE |
|----------|--------------|------------------------------------|---------|
| JM16A | 2716 TMS2516 | AMD, Motorola, National, Intel, TI | \$14.95 |
| JM16B | TMS2716 | Motorola, TI (+5, -12) | \$14.95 |
| JM32A | TMS2328 | Motorola, TI | \$14.95 |
| JM32B | 2732 | AMD, Fujitsu, NEC, Hitachi, Intel | \$14.95 |
| JM64A | MCM68764 | Motorola | \$14.95 |
| JM64B | 2764 | Intel | \$14.95 |
| JM64C | TMS2564 | TI | \$14.95 |

UV-EPROM Eraser
8 Chips - 51 Minutes
1 Chip - 37 Minutes

Erases 2708, 2716, 2732, 2764, 2516, 2532, 2564. Erases up to 8 chips within 51 minutes (1 chip in 37 minutes). Maintains constant exposure distance of one inch. Special conductive foam liner eliminates static build-up. Built-in safety lock to prevent UV exposure. Compact - only 9.00" x 3.70" x 2.60". Complete with holding tray for 8 chips.

UVS-11EL Replacement Bulb ... \$16.95
DE-4 UV-EPROM Eraser ... \$79.95

Sprite-style Fan
• 36cfm free air delivery
• 3.125" sq. x 1.665" depth
• 10 yrs. cont. duty at 20°C
• 115V 50/60Hz
PWS2107U Cleaned & tested (used) ... \$ 9.95 ea.
PWS2107F New ... \$14.95 ea.

Muffin-style Fan
• 105cfm free air delivery
• 4.68" sq. x 1.50" depth
• 10 yrs. cont. duty at 20°C
• impedance protected, ambients to 70°C
• 115V 50/60Hz 14W Wt. 17 oz.
MU2A1-U Cleaned & tested (used) ... \$9.95 ea.
MU2A1-N New ... \$14.95 ea.

FREE THE WORLD FAMOUS **ETCO** CATALOG OF ELECTRONICS

GREAT BUYS **CABLE TV STORE** **SAVE**

- VIDEO
- TELEPHONE
- CABLE TV
- PARTS
- AUDIO
- ELECTRONICS
- and much much more!

1000's OF FASCINATING FACTORY CLEAROUTS, SURPLUS SPECIALS AND BARGAIN OFFERS NOT FOUND IN STORES OR CATALOGS ANYWHERE!

ETCO ELECTRONICS
DEPT. 582
Mailing List Control Center
Box 840
Champlain, N.Y. 12919

NOW 96 PAGES

I Enclose _____ (cash OK);
Please rush postpaid

- \$1 for 1 year subscription to the world famous ETCO catalog.
- \$3 Canadian & Foreign 1 year subscription to the ETCO catalog.
- 304 page handbook "BUILD YOUR OWN EARTH STATION", (TA025) \$10.00
- 360 page MASTER HANDBOOK OF TELEPHONES. (TA001) \$11.00
- FREE - sample copy of the bargain packed ETCO catalog.

Name _____
Address _____
City _____
State _____ Zip _____

CIRCLE 65 ON FREE INFORMATION CARD

CHANEY electronics inc.

- Minimum Order \$9.00
- Please include \$1.50 for shipping (UPS)
- We accept VISA and MASTERCARD
- EXTRA FAST SERVICE

P.O. BOX 27038, DENVER, COLO. 80227
PHONE ORDERS: 303-781-5750



TRAVELLER'S COMPANION

Portable Smoke Detector And Intrusion Alarm

The Traveller's Companion is an extremely sensitive portable smoke detector and burglar-intrusion alarm system. It's made to protect you wherever you are: in hotels or motels, mobile homes, R.V.'s, offices, apartments, dormitory room and at home. Features:

- Extra loud 85db alarm horn
- Extremely sensitive dual ionization chamber smoke detector
- Fully portable — hangs on door
- Handsome carrying case for travel
- One-year limited warranty
- Operates from one 9V alkaline battery (not included)
- Size — only 5 1/2" x 2 1/4" x 1 1/2"



We are a factory authorized dealer and are offering this incredible advanced design system at this low introductory price.

C4831 \$24.95

MICRO-MINIATURE SPEAKER

Only 3/4" dia mounted on a 1" square PC board.



C4832 \$1.95 ea.

SOLID CARBIDE PC DRILL BIT

#65 .035 Standard size for PC boards.



C4800 \$1.49 ea.
10 for \$12.00

KESTER PC TYPE SOLDER

6 foot coil of ultra thin diameter low melting temperature 60:40 rosin core.



C4456 \$1.00

Kits!!!

We offer over 70 complete electronic kits. Send for our free catalog #25.

CIRCLE 66 ON FREE INFORMATION CARD

Tiger TECH ELECTRONIC COMPONENTS

PO BOX 576
BROOMFIELD, COLO. 80020

FREE Catalog with order (70¢ without)
ADD \$2.00 for postage
US MONEY ONLY PLEASE

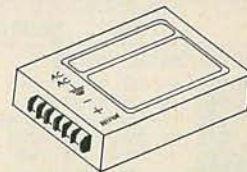

10 AMP POWERHORSE !!

5 VDC Computer power supply. 120 VAC
50-400 HZ input. External sense

LIMITED QUANTITY US\$78.95!

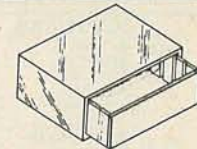

INSTRUMENT CASE

Beautiful solid anodized aluminum case with insert that holds up to six 1"x4" cards. Two lense colors!
US\$8.39 1-1/2"h x 4-1/2" x 3-1/2"d

CIRCLE 72 ON FREE INFORMATION CARD

Now You Can Afford Another 64K...

Especially when it's less than a half cent per bit!

Specifications:

- Fully Static Operation
- Supports S-100 IEEE-696 Standards
- Uses Popular 2716 Pinout Type Static RAM's
- Board Access Time Under 200nS
- 150nS RAMS Standard
- No Wait States Needed at 6.000MHz
- High Quality FR-4 Type PC Board
- Switch Selectable Phantom Line
- All Data, Status and Address Lines Fully Buffered
- Gold Plated Contact Fingers for Low Contact Resistance and Long Life
- Switch Selectable Extended Address Lines For Up To 16 M-bytes
- Extreme Low Power Dissipation (<500mA Typical)
- Top 8K May Be Switched Disabled and/or Interchangeable with 2716 Type EPROM's

COEX 64K S-100 CMOS

STATIC RAM BOARD

only **\$299⁰⁰**

Assembled & Tested

"Have You Kissed Your Computer Lately?"

Components Express, Inc.

1380 E. Edinger • Santa Ana, Calif. 92705 • 714/558-3972

Terms of Sale: Cash, Checks, Credit Cards, M.O., C.O.D. Calif. residents add 6% sales tax.



WHY PAY MORE? SHOP AMERICA'S PARTS PLACE™

Low Prices! High Quality! Wide Selection! In Stock!

Audio Compressor/ Expander

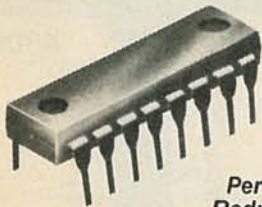

699

Perfect for Noise Reduction Systems

NE572. Dual channel—can be used either for dynamic range compression or expansion. Independent attack and recovery control. 6 to 22VDC single supply. 16-pin DIP with data.

276-1781 6.99

Sound Switch Module



199

Up to 25-Ft. Range

Just whistle—once for on, again for off! Remote-control a relay, motor, radio or TV. 6-9VDC. With data. 277-1011 1.99

43-Range Multitester 38% Off

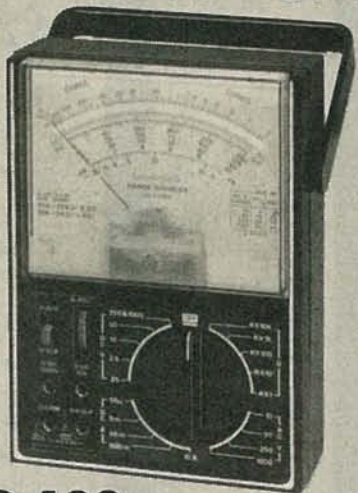

2488

Reg. 39.95

50,000 Ohms Per Volt

Measures AC and DC volts, DC millamps, resistance and dB. Range-Doubler switch. Requires one "AA", one 9V battery. With leads. 22-204 Sale 24.88

150 Disc Capacitors

Cut 31%

Reg. 9.95

688

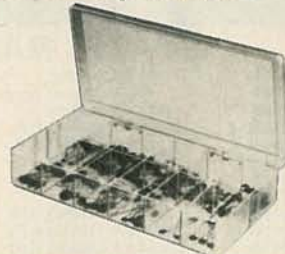

\$30.25 Individual Parts Value. 50WVDC. Contains 15 .005µF, ten each of 100, 220 and 470pF, .001, .002, .01, .02, .05, .1µF. 29 other assorted values. With chart. 272-601 Sale 6.88

Waveform Generator

595



ICL8038. Produces precise sine, square, triangle, sawtooth and pulse waves with minimum external parts. Simultaneous high-level sine, square and triangle outputs. Range: .001 Hz to 300 kHz+. Single/split supply. 14-pin DIP. 276-2334 5.95

Mini 12VDC Buzzer

169



Small enough to hide, loud enough to call attention. 1 1/16" mounting centers. With leads. 273-055 1.69

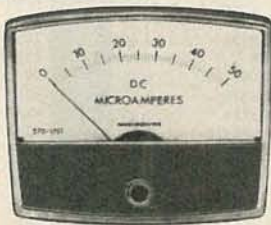

Precision Panel Meters

895 Each Monitor Your Critical DC Circuits

Jeweled movements. Accuracy: ±5% full scale. 2 3/4 x 2 1/4 x 1 1/4". Require 17/8" round mounting holes.

0-50 µA DC. 270-1751 8.95

0-1 mA DC. 270-1752 8.95

0-15VDC. 270-1754 8.95

Submini Toggle Switches

Low As **199**



• 10 Amps at 125VAC
• 1/4" Mounting Holes

CdS Photocell

129



3 megohms in darkness to 100 ohms in bright light. 200 mW at 170V, max. 276-116 1.29

SPST Toggle

299

Red LED lights when "on". 5A. For 12VDC use only. 7/16" mounting hole. 275-680 2.99



Electret Mike Element

119

Omnidirectional. PC board mounting. 2 to 10VDC, 1 mA max. 20 to 15,000 kHz. 270-090 1.19



Books to Program Your TRS-80®



54% Off
Both For Only

588



Save \$702

A Programming Techniques for Level II BASIC. Reg. \$4.95. A "cookbook" of program applications for the TRS-80 line. Describes Level II commands, data search, string manipulation, high-speed graphics and much more. Everything you need to write BASIC computer programs. 224 pages. Softbound. 62-2062

B TRS-80 Graphics. Reg. \$7.95. Explores the computer's aptitude for graphic displays, particularly line printer, character and pixel graphics. With sample programs and suggested problems and solutions. 132 pages. Softbound. 62-2073

| Description | Cat. No. | Each |
|-----------------|----------|------|
| SPST | 275-324 | 1.99 |
| SPDT | 275-326 | 2.19 |
| SPDT Center Off | 275-325 | 2.39 |
| DPDT | 275-1546 | 2.69 |
| DPDT Center Off | 275-1545 | 2.89 |

12V Snap-In Lamps

189

Panel Mounting

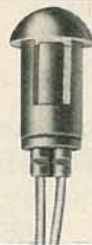

Assemblies have one amber, one blue lens. Mounting tabs for 1/2" dia. hole. 4" leads. With bulbs. 272-335 Pkg. of 2/1.89

Metal Project Enclosure

28% Off

Reg. 10.95

788

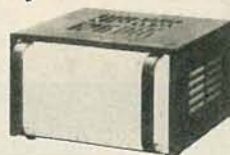

Heavy-duty. Vented steel top, aluminum front/bottom. Handles. 5 1/4 x 9 1/2 x 6 3/4". 270-270 Sale 7.88

Radio Shack®

A DIVISION OF TANDY CORPORATION • OVER 8500 LOCATIONS WORLDWIDE

Retail prices may vary at individual stores and dealers

CIRCLE 45 ON FREE INFORMATION CARD

MARCH 1983

129

4164 64K DYNAMIC \$625
200 NS

TMM2016 2KX8 STATIC \$415
200 NS

ALL MERCHANDISE 100% GUARANTEED!

CALL US FOR VOLUME QUOTES

STATIC RAMS

| | | |
|-------------|------------------------------|---------|
| 2101 | 256 x 4 (450ns) | 1.95 |
| 5101 | 256 x 4 (450ns) (cmos) | 3.95 |
| 2102-1 | 1024 x 1 (450ns) | .89 |
| 2102L-4 | 1024 x 1 (450ns) (LP) | 1.29 |
| 2102L-2 | 1024 x 1 (250ns) (LP) | 1.69 |
| 2111 | 256 x 4 (450ns) | 2.99 |
| 2112 | 256 x 4 (450ns) | 2.99 |
| 2114 | 1024 x 4 (450ns) | 8/14.95 |
| 2114L-4 | 1024 x 4 (450ns) (LP) | 8/15.25 |
| 2114L-3 | 1024 x 4 (300ns) (LP) | 8/15.45 |
| 2114L-2 | 1024 x 4 (200ns) (LP) | 8/15.95 |
| 2147 | 4096 x 1 (55ns) | 4.95 |
| TMS4044-4 | 4096 x 1 (450ns) | 3.49 |
| TMS4044-3 | 4096 x 1 (300ns) | 3.99 |
| TMS4044-2 | 4096 x 1 (200ns) | 4.49 |
| MK4118 | 1024 x 8 (250ns) | 9.95 |
| TMM2016-200 | 2048 x 8 (200ns) | 4.15 |
| TMM2016-150 | 2048 x 8 (150ns) | 4.95 |
| TMM2016-100 | 2048 x 8 (100ns) | 6.15 |
| HM6116-4 | 2048 x 8 (200ns) (cmos) | 4.95 |
| HM6116-3 | 2048 x 8 (150ns) (cmos) | 5.95 |
| HM6116-2 | 2048 x 8 (120ns) (cmos) | 8.95 |
| HM6116LP-4 | 2048 x 8 (200ns) (cmos) (LP) | 6.95 |
| HM6116LP-3 | 2048 x 8 (150ns) (cmos) (LP) | 8.95 |
| HM6116LP-2 | 2048 x 8 (120ns) (cmos) (LP) | 10.95 |
| Z-6132 | 4096 x 8 (300ns) (Qstat) | 34.95 |

LP = Low Power Qstat = Quasi-Static

DYNAMIC RAMS

| | | |
|----------|------------------------|---------|
| TMS4027 | 4096 x 1 (250ns) | 1.99 |
| UPD411 | 4096 x 1 (300ns) | 3.00 |
| MMS280 | 4096 x 1 (300ns) | 3.00 |
| MK4108 | 8192 x 1 (200ns) | 1.95 |
| MMS298 | 8192 x 1 (250ns) | 1.85 |
| 4116-300 | 16384 x 1 (300ns) | 8/11.75 |
| 4116-250 | 16384 x 1 (250ns) | 8/11.95 |
| 4116-200 | 16384 x 1 (200ns) | 8/13.95 |
| 4116-150 | 16384 x 1 (150ns) | 8/15.95 |
| 4116-120 | 16384 x 1 (120ns) | 8/29.95 |
| 2118 | 16384 x 1 (150ns) (5v) | 4.95 |
| 4164-200 | 65536 x 1 (200ns) (5v) | 6.25 |
| 4164-150 | 65536 x 1 (150ns) (5v) | 7.25 |

5V = single 5 volt supply

EPROMS

| | | |
|----------|--------------------------------|-------|
| 1702 | 256 x 8 (1us) | 4.50 |
| 2708 | 1024 x 8 (450ns) | 3.95 |
| 2758 | 1024 x 8 (450ns) (5v) | 5.95 |
| 2716 | 2048 x 8 (450ns) (5v) | 3.95 |
| 2716-1 | 2048 x 8 (350ns) (5v) | 6.25 |
| TMS2516 | 2048 x 8 (450ns) (5v) | 5.50 |
| TMS2716 | 2048 x 8 (450ns) | 7.95 |
| TMS2532 | 4096 x 8 (450ns) (5v) | 7.95 |
| 2732 | 4096 x 8 (450ns) (5v) | 4.95 |
| 2732-250 | 4096 x 8 (250ns) (5v) | 12.95 |
| 2732-200 | 4096 x 8 (200ns) (5v) | 16.95 |
| 2764 | 8192 x 8 (450ns) (5v) | 16.95 |
| 2764-250 | 8192 x 8 (250ns) (5v) | 18.95 |
| 2764-200 | 8192 x 8 (200ns) (5v) | 24.95 |
| TMS2564 | 8192 x 8 (450ns) (5v) | 24.95 |
| MC68764 | 8192 x 8 (450ns) (5v) (24 pin) | 39.95 |

5v = Single 5 Volt Supply

EPROM ERASERS

| | Timer | Capacity Chip | Intensity (uW/Cm ²) | |
|---------|-------|---------------|---------------------------------|--------|
| PE-14 | | 6 | 5,200 | 83.00 |
| PE-14T | X | 6 | 5,200 | 119.00 |
| PE-24T | X | 9 | 6,700 | 175.00 |
| PL-265T | X | 20 | 6,700 | 255.00 |
| PR-125T | X | 16 | 15,000 | 349.00 |
| PR-320 | X | 32 | 15,000 | 595.00 |

DISC CONTROLLERS

| | |
|--------|-------|
| 1771 | 16.95 |
| 1791 | 29.95 |
| 1793 | 38.95 |
| 1795 | 54.95 |
| 1797 | 54.95 |
| 6843 | 34.95 |
| 8272 | 39.95 |
| UPD765 | 39.95 |
| 1691 | 18.95 |
| 2143 | 18.95 |

INTERFACE

| | |
|--------|------|
| 8T26 | 1.69 |
| 8T28 | 2.49 |
| 8T95 | .99 |
| 8T96 | .99 |
| 8T97 | .99 |
| 8T98 | .99 |
| DM8131 | 2.95 |
| DP8304 | 2.29 |
| DS8835 | 1.99 |
| DS8836 | .99 |

MISC.

| | |
|--------------|-------|
| 3242 | 7.95 |
| 3341 | 4.95 |
| MC3470 | 4.95 |
| MC3480 | 9.00 |
| 11C90 | 13.95 |
| 95H90 | 7.95 |
| 2513-001 UP | 9.95 |
| 2513-002 LOW | 9.95 |

SOUND CHIPS

| | |
|----------|-------|
| 76477 | 3.95 |
| 76489 | 8.95 |
| AY3-8910 | 12.95 |
| MC3340 | 1.49 |

CRT CONTROLLERS

| | |
|-----------|-------|
| 6845 | 14.95 |
| 68B45 | 35.95 |
| HD46505SP | 15.95 |
| 6847 | 12.25 |
| MC1372 | 6.95 |
| 68047 | 24.95 |
| 8275 | 29.95 |
| 7220 | 99.95 |
| CRT5027 | 39.95 |
| CRT5037 | 49.95 |
| TMS9918A | 39.95 |
| DP8350 | 49.95 |

BIT-RATE GENERATORS

| | |
|---------|-------|
| MC14411 | 11.95 |
| BR1941 | 11.95 |
| 4702 | 12.95 |
| COM5016 | 16.95 |
| COM8116 | 10.95 |
| MMS5307 | 10.95 |

UARTS

| | |
|----------|-------|
| AY3-1014 | 6.95 |
| AY5-1013 | 3.95 |
| AY3-1015 | 6.95 |
| PT1472 | 9.95 |
| TR1602 | 3.95 |
| 2350 | 9.95 |
| 2651 | 8.95 |
| TMS6011 | 5.95 |
| IM6402 | 7.95 |
| IM6403 | 8.95 |
| INS8250 | 14.95 |

KEYBOARD CHIPS

| | |
|----------|-------|
| AY5-2376 | 11.95 |
| AY5-3600 | 11.95 |

CLOCK CIRCUITS

| | |
|---------|-------|
| MMS314 | 4.95 |
| MMS369 | 3.95 |
| MMS375 | 4.95 |
| MMS8167 | 8.95 |
| MMS8174 | 11.95 |
| MSM5832 | 6.95 |

Z-80 2.5 Mhz

| | |
|-----------|-------|
| Z80-CPU | 3.95 |
| Z80-CTC | 5.95 |
| Z80-DART | 15.25 |
| Z80-DMA | 17.50 |
| Z80-PIO | 5.75 |
| Z80-SIO/0 | 18.50 |
| Z80-SIO/1 | 18.50 |
| Z80-SIO/2 | 18.50 |
| Z80-SIO/9 | 16.95 |

4.0 Mhz

| | |
|------------|-------|
| Z80A-CPU | 6.00 |
| Z80A-CTC | 8.65 |
| Z80A-DART | 18.75 |
| Z80A-DMA | 27.50 |
| Z80A-PIO | 6.00 |
| Z80A-SIO/0 | 22.50 |
| Z80A-SIO/1 | 22.50 |
| Z80A-SIO/2 | 22.50 |
| Z80A-SIO/9 | 19.95 |

6.0 Mhz

| | |
|----------|-------|
| Z80B-CPU | 17.95 |
| Z80B-CTC | 15.50 |
| Z80B-PIO | 15.50 |

ZILOG

| | |
|-------|-------|
| Z6132 | 34.95 |
| Z8671 | 39.95 |

CRYSTALS

| | |
|------------|------|
| 32.768 khz | 1.95 |
| 1.0 mhz | 4.95 |
| 1.8432 | 4.95 |
| 2.0 | 3.95 |
| 2.097152 | 3.95 |
| 2.4576 | 3.95 |
| 3.2768 | 3.95 |
| 3.579535 | 3.95 |
| 4.0 | 3.95 |
| 5.0 | 3.95 |
| 5.0688 | 3.95 |
| 5.185 | 3.95 |
| 5.7143 | 3.95 |
| 6.0 | 3.95 |
| 6.144 | 3.95 |
| 6.5536 | 3.95 |
| 8.0 | 3.95 |
| 10.738635 | 3.95 |
| 14.31818 | 3.95 |
| 15.0 | 3.95 |
| 16.0 | 3.95 |
| 17.430 | 3.95 |
| 18.0 | 3.95 |
| 18.432 | 3.95 |
| 20.0 | 3.95 |
| 22.1184 | 3.95 |
| 32.0 | 3.95 |

DATA ACQUISITION

| | |
|----------|-------|
| ADC0800 | 15.55 |
| ADC0804 | 3.49 |
| ADC0809 | 4.49 |
| ADC0817 | 9.95 |
| DAC0800 | 4.95 |
| DAC0806 | 1.95 |
| DAC0808 | 2.95 |
| DAC1020 | 8.25 |
| DAC1022 | 5.95 |
| MC1408L6 | 1.95 |
| MC1408L8 | 2.95 |

8000

| | |
|----------|-------|
| 8035 | 5.95 |
| 8039 | 6.95 |
| INS-8060 | 17.95 |
| INS-8073 | 24.95 |
| 8080 | 3.95 |
| 8085 | 5.95 |
| 8085A-2 | 11.95 |
| 8086 | 29.95 |
| 8087 | 39.95 |
| 8088 | 39.95 |
| 8089 | 89.95 |
| 8155 | 7.95 |
| 8156 | 8.95 |
| 8185-2 | 39.95 |
| 8741 | 39.95 |
| 8748 | 29.95 |
| 8755 | 32.00 |

8200

| | |
|--------|-------|
| 8202 | 29.95 |
| 8203 | 39.95 |
| 8205 | 3.50 |
| 8212 | 1.80 |
| 8214 | 3.85 |
| 8216 | 1.75 |
| 8224 | 2.25 |
| 8226 | 1.80 |
| 8228 | 3.49 |
| 8237 | 19.95 |
| 8238 | 4.49 |
| 8243 | 4.45 |
| 8250 | 10.95 |
| 8251 | 4.49 |
| 8253 | 6.95 |
| 8253-5 | 7.95 |
| 8255 | 4.49 |
| 8255-5 | 5.25 |
| 8257 | 7.95 |
| 8257-5 | 8.95 |
| 8259 | 6.90 |
| 8259-5 | 7.50 |
| 8271 | 39.95 |
| 8272 | 39.95 |
| 8275 | 29.95 |
| 8279 | 8.95 |
| 8279-5 | 10.00 |
| 8282 | 6.50 |
| 8283 | 6.50 |
| 8284 | 5.50 |
| 8286 | 6.50 |
| 8287 | 6.50 |
| 8288 | 25.00 |
| 8289 | 49.95 |

FUNCTION GENERATORS

| | |
|--------|------|
| MC4024 | 3.95 |
| LM566 | 1.49 |
| XR2206 | 3.75 |
| 8038 | 3.95 |

INTERSIL

| | |
|----------|-------|
| ICL7103 | 9.50 |
| ICL7106 | 9.95 |
| ICL7107 | 12.95 |
| ICL7660 | 2.95 |
| ICL8038 | 3.95 |
| ICM7207A | 5.59 |
| ICM7208 | 15.95 |

6800

| | |
|-------|-------|
| 68000 | 59.95 |
| 6800 | 4.95 |
| 6802 | 7.95 |
| 6808 | 13.90 |
| 6809E | 19.95 |
| 6809 | 12.95 |
| 6810 | 2.95 |
| 6820 | 4.95 |
| 6821 | 3.25 |
| 6828 | 14.95 |
| 6840 | 12.95 |
| 6843 | 34.95 |
| 6844 | 25.95 |
| 6845 | 14.95 |
| 6847 | 12.25 |
| 6850 | 3.45 |
| 6852 | 5.75 |
| 6860 | 9.95 |
| 6862 | 11.95 |
| 6875 | 6.95 |
| 6880 | 2.25 |
| 6883 | 24.95 |
| 68047 | 24.95 |
| 68488 | 19.95 |

6800 - 1MHZ

| | |
|--------|-------|
| 68B00 | 10.95 |
| 68B02 | 22.25 |
| 68B09E | 29.95 |
| 68B09 | 29.95 |
| 68B10 | 7.95 |
| 68B21 | 12.95 |
| 68B45 | 35.95 |
| 68B50 | 12.95 |

6500 1MHZ

| | |
|------|-------|
| 6502 | 5.95 |
| 6504 | 6.95 |
| 6505 | 8.95 |
| 6507 | 9.95 |
| 6520 | 4.35 |
| 6522 | 8.75 |
| 6532 | 11.25 |
| 6545 | 22.50 |
| 6551 | 11.85 |

2 MHZ

| | |
|-------|-------|
| 6502A | 9.95 |
| 6522A | 11.70 |
| 6532A | 12.40 |
| 6545A | 28.50 |
| 6551A | 12.95 |

3 MHZ

| | |
|-------|-------|
| 6502B | 14.95 |
|-------|-------|

EXAR

| | |
|---------|------|
| XR 2206 | 3.75 |
| XR 2207 | 3.85 |
| XR 2208 | 3.90 |
| XR 2211 | 5.25 |
| XR 2240 | 3.25 |

9000 SERIES

| | |
|-------|------|
| 9316 | 1.00 |
| 9334 | 2.50 |
| 9368 | 3.95 |
| 9401 | 9.95 |
| 9601 | .75 |
| 9602 | 1.50 |
| 96S02 | 1.95 |

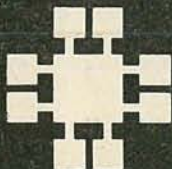

JDR MICRODEVICES, INC.

1224 S. Bascom Avenue
San Jose, CA 95128
800-538-5000 • 800-662-6279 (CA)
(408) 995-5430 • Telex 171-110

©1982 JDR MICRODEVICES, INC.

VISIT OUR RETAIL STORE — NEW HOURS —
M-W-F, 9-5
T-Th., 9-9 Sat. 11-3

PLEASE USE YOUR CUSTOMER NUMBER WHEN ORDERING

TERMS: For shipping include \$2 for UPS Ground or \$3 for UPS Blue Label Air. Items over 5 pounds require additional shipping charges. Foreign orders, include sufficient amount for shipping. There is a \$10 minimum order. Bay Area and Los Angeles Counties add 6% Sales Tax. Other California residents add 6% Sales Tax. We reserve the right to substitute manufacturer. Not responsible

2716 16K EPROMS **\$3.95** EACH

ALL MERCHANDISE 100% GUARANTEED!

2732 32K EPROMS **\$4.95** EACH

CALL US FOR VOLUME QUOTES

74LS00

| | | | | | | | |
|--------|------|---------|------|---------|------|----------|-------|
| 74LS00 | .24 | 74LS86 | .39 | 74LS169 | 1.75 | 74LS323 | 3.50 |
| 74LS01 | .25 | 74LS90 | .55 | 74LS170 | 1.49 | 74LS324 | 1.75 |
| 74LS02 | .25 | 74LS91 | .89 | 74LS173 | .69 | 74LS352 | 1.29 |
| 74LS03 | .25 | 74LS92 | .55 | 74LS174 | .55 | 74LS353 | 1.29 |
| 74LS04 | .24 | 74LS93 | .55 | 74LS175 | .55 | 74LS363 | 1.35 |
| 74LS05 | .25 | 74LS95 | .75 | 74LS181 | 2.15 | 74LS364 | 1.95 |
| 74LS08 | .28 | 74LS96 | .89 | 74LS189 | 8.95 | 74LS365 | .49 |
| 74LS09 | .29 | 74LS107 | .39 | 74LS190 | .89 | 74LS366 | .49 |
| 74LS10 | .25 | 74LS109 | .39 | 74LS191 | .89 | 74LS367 | .45 |
| 74LS11 | .35 | 74LS112 | .39 | 74LS192 | .79 | 74LS368 | .45 |
| 74LS12 | .35 | 74LS113 | .39 | 74LS193 | .79 | 74LS373 | .99 |
| 74LS13 | .45 | 74LS114 | .39 | 74LS194 | .69 | 74LS374 | .99 |
| 74LS14 | .59 | 74LS122 | .45 | 74LS195 | .69 | 74LS377 | 1.39 |
| 74LS15 | .35 | 74LS123 | .79 | 74LS196 | .79 | 74LS378 | 1.18 |
| 74LS20 | .25 | 74LS124 | 2.90 | 74LS197 | .79 | 74LS379 | 1.35 |
| 74LS21 | .29 | 74LS125 | .49 | 74LS199 | .89 | 74LS385 | 1.90 |
| 74LS22 | .25 | 74LS126 | .49 | 74LS240 | .95 | 74LS386 | .45 |
| 74LS26 | .29 | 74LS132 | .59 | 74LS241 | .99 | 74LS390 | 1.19 |
| 74LS27 | .29 | 74LS133 | .59 | 74LS242 | .99 | 74LS393 | 1.19 |
| 74LS28 | .35 | 74LS136 | .39 | 74LS243 | .99 | 74LS395 | 1.19 |
| 74LS30 | .25 | 74LS137 | .99 | 74LS244 | .99 | 74LS399 | 1.49 |
| 74LS32 | .29 | 74LS138 | .55 | 74LS245 | 1.49 | 74LS424 | 2.95 |
| 74LS33 | .55 | 74LS139 | .55 | 74LS247 | .75 | 74LS447 | .37 |
| 74LS37 | .35 | 74LS145 | 1.20 | 74LS248 | .99 | 74LS490 | 1.95 |
| 74LS38 | .35 | 74LS147 | 2.49 | 74LS249 | .99 | 74LS624 | 3.99 |
| 74LS40 | .25 | 74LS148 | 1.35 | 74LS251 | .59 | 74LS668 | 1.89 |
| 74LS42 | .49 | 74LS151 | .55 | 74LS253 | .59 | 74LS669 | 1.89 |
| 74LS47 | .75 | 74LS153 | .55 | 74LS257 | .59 | 74LS670 | 1.49 |
| 74LS48 | .75 | 74LS154 | 1.90 | 74LS258 | .59 | 74LS674 | 9.65 |
| 74LS49 | .75 | 74LS155 | .69 | 74LS259 | 2.75 | 74LS682 | 3.20 |
| 74LS51 | .25 | 74LS156 | .69 | 74LS260 | .59 | 74LS683 | 3.20 |
| 74LS54 | .29 | 74LS157 | .65 | 74LS266 | .55 | 74LS684 | 3.20 |
| 74LS55 | .29 | 74LS158 | .59 | 74LS273 | 1.49 | 74LS685 | 3.20 |
| 74LS63 | 1.25 | 74LS160 | .69 | 74LS275 | 3.35 | 74LS688 | 2.40 |
| 74LS73 | .39 | 74LS161 | .65 | 74LS279 | .49 | 74LS689 | 3.20 |
| 74LS74 | .35 | 74LS162 | .69 | 74LS280 | 1.98 | 74LS783 | 24.95 |
| 74LS75 | .39 | 74LS163 | .65 | 74LS283 | .69 | 81LS95 | 1.49 |
| 74LS76 | .39 | 74LS164 | .69 | 74LS290 | .89 | 81LS96 | 1.49 |
| 74LS78 | .49 | 74LS165 | .95 | 74LS293 | .89 | 81LS97 | 1.49 |
| 74LS83 | .60 | 74LS166 | 1.95 | 74LS295 | .99 | 81LS98 | 1.49 |
| 74LS85 | .69 | 74LS168 | 1.75 | 74LS298 | .89 | 25LS2521 | 2.80 |
| | | | | 74LS299 | 1.75 | 25LS2569 | 4.25 |

IC SOCKETS

| | | |
|--|-------|------|
| 8 pin ST | 1-99 | 100 |
| 14 pin ST | .13 | .11 |
| 16 pin ST | .15 | .12 |
| 18 pin ST | .17 | .13 |
| 20 pin ST | .20 | .18 |
| 22 pin ST | .29 | .27 |
| 24 pin ST | .30 | .27 |
| 28 pin ST | .40 | .32 |
| 40 pin ST | .49 | .39 |
| 64 pin ST | 4.25 | call |
| ST - SOLDERTAIL | | |
| 8 pin WW | .59 | .49 |
| 14 pin WW | .69 | .52 |
| 16 pin WW | .69 | .58 |
| 18 pin WW | .99 | .90 |
| 20 pin WW | 1.09 | .98 |
| 22 pin WW | 1.39 | 1.28 |
| 24 pin WW | 1.49 | 1.35 |
| 28 pin WW | 1.69 | 1.49 |
| 40 pin WW | 1.99 | 1.80 |
| WW - WIREWRAP | | |
| 16 pin ZIF | 6.75 | call |
| 24 pin ZIF | 9.95 | call |
| 28 pin ZIF | 10.95 | call |
| ZIF - TEXTPOOL (Zero Insertion Force) | | |

CONNECTORS

| | |
|--------------|------|
| RS232 MALE | 2.95 |
| RS232 FEMALE | 3.50 |
| RS232 FEMALE | 3.50 |
| RIGHT ANGLE | 5.25 |
| RS232 HOOD | 1.25 |
| S-100 ST | 3.95 |
| S-100 WW | 4.95 |

DIP SWITCHES

| | |
|------------|-----|
| 4 POSITION | .85 |
| 5 POSITION | .90 |
| 6 POSITION | .90 |
| 7 POSITION | .95 |
| 8 POSITION | .95 |

7400

| | | | |
|-------|------|-------|-------|
| 7400 | .19 | 74132 | .45 |
| 7401 | .19 | 74136 | .50 |
| 7402 | .19 | 74141 | .65 |
| 7403 | .19 | 74142 | 2.95 |
| 7404 | .19 | 74143 | 2.95 |
| 7405 | .25 | 74145 | .60 |
| 7406 | .29 | 74147 | 1.75 |
| 7407 | .29 | 74148 | 1.20 |
| 7408 | .24 | 74150 | 1.35 |
| 7409 | .19 | 74151 | .55 |
| 7410 | .19 | 74152 | .65 |
| 7411 | .25 | 74153 | .55 |
| 7412 | .30 | 74154 | 1.25 |
| 7413 | .35 | 74155 | .75 |
| 7414 | .49 | 74156 | .65 |
| 7416 | .25 | 74157 | .55 |
| 7417 | .25 | 74159 | 1.65 |
| 7420 | .19 | 74160 | .85 |
| 7421 | .35 | 74161 | .69 |
| 7422 | .35 | 74162 | .85 |
| 7423 | .29 | 74163 | .69 |
| 7425 | .29 | 74164 | .87 |
| 7426 | .29 | 74165 | .85 |
| 7427 | .29 | 74166 | 1.00 |
| 7428 | .45 | 74167 | 2.95 |
| 7430 | .19 | 74170 | 1.65 |
| 7432 | .29 | 74172 | 5.95 |
| 7433 | .45 | 74173 | .75 |
| 7437 | .29 | 74174 | .89 |
| 7438 | .29 | 74175 | .89 |
| 7440 | .19 | 74176 | .89 |
| 7442 | .49 | 74177 | .75 |
| 7443 | .65 | 74178 | 1.15 |
| 7444 | .69 | 74179 | 1.75 |
| 7445 | .69 | 74180 | .75 |
| 7446 | .69 | 74181 | 2.25 |
| 7447 | .69 | 74182 | .75 |
| 7448 | .69 | 74184 | 2.00 |
| 7450 | .19 | 74185 | 2.00 |
| 7451 | .23 | 74186 | 18.50 |
| 7453 | .23 | 74190 | 1.15 |
| 7454 | .23 | 74191 | 1.15 |
| 7460 | .23 | 74192 | .79 |
| 7470 | .35 | 74193 | .79 |
| 7472 | .29 | 74194 | .85 |
| 7473 | .34 | 74195 | .85 |
| 7474 | .33 | 74196 | .79 |
| 7475 | .45 | 74197 | .75 |
| 7476 | .35 | 74198 | 1.35 |
| 7480 | .59 | 74199 | 1.35 |
| 7481 | 1.10 | 74221 | 1.35 |
| 7482 | .95 | 74246 | 1.35 |
| 7483 | .50 | 74247 | 1.25 |
| 7485 | .59 | 74248 | 1.85 |
| 7486 | .35 | 74249 | 1.95 |
| 7489 | 2.15 | 74251 | .75 |
| 7490 | .35 | 74259 | 2.25 |
| 7491 | .40 | 74265 | 1.35 |
| 7492 | .50 | 74273 | 1.95 |
| 7493 | .35 | 74276 | 1.25 |
| 7494 | .65 | 74279 | .75 |
| 7495 | .55 | 74283 | 2.00 |
| 7496 | .70 | 74284 | 3.75 |
| 7497 | 2.75 | 74285 | 3.75 |
| 74100 | 1.75 | 74290 | .95 |
| 74107 | .30 | 74293 | .75 |
| 74109 | .45 | 74298 | .85 |
| 74110 | .45 | 74351 | 2.25 |
| 74111 | .55 | 74365 | .65 |
| 74116 | 1.55 | 74366 | .65 |
| 74120 | 1.20 | 74367 | .65 |
| 74121 | .29 | 74368 | .65 |
| 74122 | .45 | 74376 | 2.20 |
| 74123 | .49 | 74390 | 1.75 |
| 74125 | .45 | 74393 | 1.35 |
| 74126 | .45 | 74425 | 3.15 |
| 74128 | .55 | 74426 | .85 |
| | | 74490 | 2.55 |

CMOS

| | | | |
|-------|-------|--------|-------|
| 4000 | .29 | 4527 | 1.95 |
| 4001 | .25 | 4528 | 1.19 |
| 4002 | .25 | 4531 | .95 |
| 4006 | .89 | 4532 | 1.95 |
| 4007 | .29 | 4538 | 1.95 |
| 4008 | .95 | 4539 | 1.95 |
| 4009 | .39 | 4541 | 2.64 |
| 4010 | .45 | 4543 | 1.19 |
| 4011 | .25 | 4553 | 5.79 |
| 4012 | .25 | 4555 | .95 |
| 4013 | .38 | 4556 | .95 |
| 4014 | .79 | 4581 | 1.95 |
| 4015 | .39 | 4582 | 1.95 |
| 4016 | .39 | 4584 | .75 |
| 4017 | .69 | 4585 | .75 |
| 4018 | .79 | 4702 | 12.95 |
| 4019 | .39 | 74C00 | .35 |
| 4020 | .75 | 74C02 | .35 |
| 4021 | .79 | 74C04 | .35 |
| 4022 | .79 | 74C08 | .35 |
| 4023 | .29 | 74C10 | .35 |
| 4024 | .65 | 74C14 | .59 |
| 4025 | .29 | 74C20 | .35 |
| 4026 | 1.65 | 74C30 | .35 |
| 4027 | .45 | 74C32 | .39 |
| 4028 | .69 | 74C42 | 1.29 |
| 4029 | .79 | 74C48 | 1.99 |
| 4030 | .39 | 74C73 | .65 |
| 4034 | 1.95 | 74C74 | .65 |
| 4035 | .85 | 74C76 | .80 |
| 4040 | .75 | 74C83 | 1.95 |
| 4041 | .75 | 74C85 | 1.95 |
| 4042 | .69 | 74C86 | .39 |
| 4043 | .85 | 74C89 | 4.50 |
| 4044 | .79 | 74C90 | 1.19 |
| 4046 | .85 | 74C93 | 1.75 |
| 4047 | .95 | 74C95 | .99 |
| 4049 | .35 | 74C107 | .89 |
| 4050 | .35 | 74C150 | 5.75 |
| 4051 | .79 | 74C151 | 2.25 |
| 4053 | .79 | 74C154 | 3.25 |
| 4060 | .89 | 74C157 | 1.75 |
| 4066 | .39 | 74C160 | 1.19 |
| 4068 | .39 | 74C161 | 1.19 |
| 4069 | .29 | 74C162 | 1.19 |
| 4070 | .35 | 74C163 | 1.19 |
| 4071 | .29 | 74C164 | 1.39 |
| 4072 | .29 | 74C165 | 2.00 |
| 4073 | .29 | 74C173 | .79 |
| 4075 | .29 | 74C174 | 1.19 |
| 4076 | .79 | 74C175 | 1.19 |
| 4078 | .29 | 74C192 | 1.49 |
| 4081 | .29 | 74C193 | 1.49 |
| 4082 | .29 | 74C195 | 1.39 |
| 4085 | .95 | 74C200 | 5.75 |
| 4086 | .95 | 74C221 | 1.75 |
| 4093 | .49 | 74C373 | 2.45 |
| 4098 | 2.49 | 74C374 | 2.45 |
| 4099 | 1.95 | 74C901 | .39 |
| 14409 | 12.95 | 74C902 | .85 |
| 14410 | 12.95 | 74C903 | .85 |
| 14411 | 11.95 | 74C905 | 10.95 |
| 14412 | 12.95 | 74C906 | .95 |
| 14419 | 7.95 | 74C907 | 1.00 |
| 14433 | 4.18 | 74C908 | 2.00 |
| 4502 | .95 | 74C909 | 2.75 |
| 4503 | .65 | 74C911 | 8.95 |
| 4508 | 1.95 | 74C912 | 8.95 |
| 4510 | .85 | 74C914 | 1.95 |
| 4511 | .85 | 74C915 | 1.19 |
| 4512 | .85 | 74C918 | 2.75 |
| 4514 | 1.25 | 74C920 | 17.95 |
| 4515 | 1.79 | 74C921 | 15.95 |
| 4516 | 1.55 | 74C922 | 4.49 |
| 4518 | .89 | 74C923 | 4.95 |
| 4519 | .39 | 74C925 | 5.95 |
| 4520 | .79 | 74C926 | 7.95 |
| 4522 | 1.25 | 74C928 | 7.95 |
| 4526 | 1.25 | 74C929 | 19.95 |

Prices Slashed! 74S00

| | | | |
|--------|------|--------|-------|
| 74S00 | .32 | 74S163 | 1.95 |
| 74S02 | .35 | 74S168 | 3.95 |
| 74S03 | .35 | 74S169 | 3.95 |
| 74S04 | .35 | 74S174 | .95 |
| 74S05 | .35 | 74S175 | .95 |
| 74S08 | .35 | 74S181 | 3.95 |
| 74S09 | .40 | 74S182 | 2.95 |
| 74S10 | .35 | 74S188 | 1.95 |
| 74S11 | .35 | 74S189 | 6.95 |
| 74S15 | .35 | 74S194 | 1.49 |
| 74S20 | .35 | 74S195 | 1.49 |
| 74S22 | .35 | 74S196 | 1.49 |
| 74S30 | .35 | 74S197 | 1.49 |
| 74S32 | .40 | 74S201 | 6.95 |
| 74S37 | .88 | 74S225 | 7.95 |
| 74S38 | .85 | 74S240 | 2.20 |
| 74S40 | .35 | 74S241 | 2.20 |
| 74S51 | .35 | 74S244 | 2.20 |
| 74S64 | .40 | 74S251 | .95 |
| 74S65 | .40 | 74S253 | .95 |
| 74S74 | .50 | 74S257 | .95 |
| 74S85 | 1.99 | 74S258 | .95 |
| 74S86 | .50 | 74S260 | .79 |
| 74S112 | .50 | 74S274 | 19.95 |
| 74S113 | .50 | 74S275 | 19.95 |
| 74S114 | .55 | | |

LINEAR

| | | | | | | | |
|------------------|-------|----------|--------|-----------|--------|---------|------|
| LM301 | .34 | LM348 | .99 | NE564 | 2.95 | LM1496 | .85 |
| LM301H | .79 | LM350K | 4.95 | LM565 | .99 | LM1558H | 3.10 |
| LM307 | .45 | LM350T | 4.60 | LM566 | 1.49 | LM1800 | 2.37 |
| LM308 | .69 | LM358 | .69 | LM567 | .89 | LM1812 | 8.25 |
| LM308H | 1.15 | LM359 | 1.79 | NE570 | 3.95 | LM1830 | 3.50 |
| LM309H | 1.95 | LM376 | 3.75 | NE571 | 2.95 | LM1871 | 5.49 |
| LM309K | 1.25 | LM377 | 1.95 | NE592 | 2.75 | LM1872 | 5.49 |
| LM310 | 1.75 | LM378 | 2.50 | LM703 | .89 | LM1877 | 3.25 |
| LM311 | .64 | LM379 | 4.50 | LM709 | .59 | LM1889 | 1.95 |
| LM311H | .89 | LM380 | .89 | LM710 | .75 | LM1896 | 1.75 |
| LM312H | 1.75 | LM380N-8 | 1.10 | LM711 | .79 | LM2877 | 2.05 |
| LM317K | 3.95 | LM381 | 1.60 | LM723 | .49 | LM2878 | 2.25 |
| LM317T | 1.19 | LM382 | 1.60 | LM723H | .55 | LM2900 | .85 |
| LM318 | 1.49 | LM383 | 1.95 | LM733 | .98 | LM2901 | 1.00 |
| LM318H | 1.59 | LM384 | 1.95 | LM741 | .35 | LM3900 | .59 |
| LM319H | 1.90 | LM386 | .89 | LM741N-14 | .35 | LM3905 | 1.25 |
| LM319 | 1.25 | LM387 | 1.40 | LM741H | .40 | LM3909 | .98 |
| LM320 (see 7900) | LM389 | 1.35 | LM747 | .69 | LM3911 | 2.25 | |
| LM322 | 1.65 | LM390 | 1.95 | LM748 | .59 | LM3914 | 3.95 |
| LM323K | 4.95 | LM392 | .69 | LM1014 | 1.19 | LM3915 | 3.95 |
| LM324 | .59 | LM394H | 4.60 | LM1303 | 1.95 | LM3916 | 3.95 |
| LM329 | .65 | LM399H | 5.00 | LM1310 | 1.49 | MC4024 | 3.95 |
| LM331 | 3.95 | NE531 | 2.95 | MC1330 | 1.69 | MC4044 | 4.50 |
| LM334 | 1.19 | NE536 | 6.00 | MC1349 | 1.89 | RC4136 | 1.25 |
| LM335 | 1.40 | NE555 | .34 | MC1350 | 1.19 | RC4151 | 3.95 |
| LM336 | 1.75 | NE556 | .65 | MC1358 | 1.69 | LM4250 | 1.75 |
| LM337K | 3.95 | NE558 | 1.50 | MC1372 | 6.95 | LM4500 | 3.25 |
| LM337T | 1.95 | NE555 | .34 | LM1414 | 1.59 | LM13080 | 1.29 |
| LM338K | 6.95 | NE556 | .65 | LM1458 | .59 | LM13600 | 1.49 |
| LM339 | .99 | NE558 | 1.50 | LM1488 | .69 | LM13700 | 1.49 |
| LM340 (see 7800) | NE561 | 24.95 | LM1489 | .69 | | | |

H = TO-5 CAN

T = TO-220

K = TO-3

RCA

| | | | |
|---------|------|---------|------|
| CA 3023 | 2.75 | CA 3082 | 1.65 |
| CA 3039 | 1.29 | CA 3083 | 1.55 |
| CA 3046 | 1.25 | CA 3086 | .80 |
| CA 3059 | 2.90 | CA 3089 | 2.99 |
| CA 3060 | 2.90 | CA 3096 | 3.49 |
| CA 3065 | 1.75 | CA 3130 | 1.30 |
| CA 3080 | 1.10 | CA 3140 | 1.15 |
| CA 3081 | 1.65 | CA 3146 | 1.85 |
| | | CA 3160 | 1.19 |

TI

| | | | |
|-------|------|-------|------|
| TL494 | 4.20 | 75365 | 1.95 |
| TL496 | 1.65 | 75450 | .59 |
| TL497 | 3.25 | 75451 | .39 |
| 75107 | 1.49 | 75452 | .39 |
| 75110 | 1.95 | 75453 | .39 |
| 75150 | 1.95 | 75454 | .39 |
| 75154 | 1.95 | 75491 | .79 |
| 75188 | 1.25 | 75492 | .79 |
| 75189 | 1.25 | 75493 | .89 |
| | | 75494 | .89 |

BI FET

| | | | |
|-------|------|-------|------|
| TL071 | .79 | TL084 | 2.19 |
| TL072 | 1.19 | LF347 | 2.19 |
| TL074 | 2.19 | LF351 | .60 |
| TL081 | .79 | LF353 | 1.00 |
| TL082 | 1.19 | LF355 | 1.10 |
| TL083 | 1.19 | LF356 | 1.10 |
| | | LF357 | 1.40 |

VOLTAGE REGULATORS

| | | | |
|--------|------|---------|------|
| 7805T | .89 | 7905T | .99 |
| 7808T | .89 | 7908T | .99 |
| 7812T | .89 | 7912T | .99 |
| 7815T | .89 | 7915T | .99 |
| 7824T | .89 | 7924T | .99 |
| 7805K | 1.39 | 7905K | 1.49 |
| 7812K | 1.39 | 7912K | 1.49 |
| 7815K | 1.39 | 7915K | 1.49 |
| 7824K | 1.39 | 7924K | 1.49 |
| 78L05 | .69 | 79L05 | .79 |
| 78L12 | .69 | 79L12 | .79 |
| 78L15 | .69 | 79L15 | .79 |
| 78H05K | 9.95 | LM323K | 4.95 |
| 78H12K | 9.95 | UA78540 | 1.95 |

T = TO-220

K = TO-3

L = TO-92

DISK DRIVES

TANDON

| | | |
|---------|------------------------|--------|
| TM100-1 | 5 1/4" (FOR IBM) SS/DD | 229.00 |
| TM100-2 | 5 1/4" (FOR IBM) DS/DD | 295.00 |

SHUGART

| | | |
|---------|-------------------------|--------|
| SA 400L | 5 1/4" (40 TRACK) SS/DD | 199.95 |
|---------|-------------------------|--------|

SIEMENS

| | | |
|---------|----------------------------|--------|
| FD100-8 | 8" SS/DD (801 REPLACEMENT) | 259.00 |
|---------|----------------------------|--------|

PERTEC

| | | |
|--------|--------------|--------|
| FD-200 | 5 1/4" SS/DD | 179.95 |
| FN-250 | 5 1/4" DS/DD | 199.95 |

RIBBON CABLE

| CONTACTS | SINGLE COLOR | | COLOR CODED | |
|----------|--------------|-------|-------------|-------|
| | 1' | 10' | 1' | 10' |
| 10 | .50 | 4.40 | .83 | 7.30 |
| 20 | .65 | 5.70 | 1.25 | 11.00 |
| 26 | .75 | 6.60 | 1.32 | 11.60 |
| 34 | .98 | 8.60 | 1.65 | 14.50 |
| 40 | 1.32 | 11.60 | 1.92 | 16.80 |
| 50 | 1.38 | 12.10 | 2.50 | 22.00 |

WE HAVE THE COMPLETE LINE OF IDC AND D-SUBMINIATURE CONNECTORS

WIREWRAP CARDS

FR-4 Epoxy Glass Laminate
With Gold Plated Contact Fingers

S-100 BUSS

| | | |
|--------|---------------------------|-------|
| P100-1 | Bare — No Foil Pads | 15.95 |
| P100-2 | Horizontal BUSS | 22.95 |
| P100-3 | Vertical BUSS | 22.95 |
| P100-4 | Single Foil Pads Per Hole | 23.95 |

APPLE

| | | |
|--------|---------------------------|-------|
| P500-1 | Bare — No Foil Pads | 15.95 |
| P500-3 | Horizontal BUSS | 22.95 |
| P500-4 | Single Foil Pads Per Hole | 23.95 |

IBM

| | | |
|--------|-------------------|-------|
| IBM-PR | BUSS Lines + Pads | 55.00 |
|--------|-------------------|-------|

GENERAL PURPOSE

22/44 PIN (.156" SPACING)

| | | |
|--------|--------------------------|-------|
| P441-3 | Vertical BUSS, 4.5" x 6" | 13.95 |
| P442-3 | Vertical BUSS, 4.5" x 9" | 14.95 |

36/72 PIN (.1" SPACING)

| | | |
|--------|--------------------------|-------|
| P721-3 | Vertical BUSS, 4.5" x 6" | 13.95 |
| P722-3 | Vertical BUSS, 4.5" x 9" | 14.95 |

BEST SELLING BOOKS

OSBORNE/MC GRAW-HILL

| | |
|-------------------------------------|-------|
| Apple II User's Guide | 16.95 |
| CRT Controller's Handbook | 9.95 |
| 68000 Assembly Language Programming | 16.99 |
| CBASIC User Guide | 15.00 |

SYBEX

| | |
|---------------------------------------|-------|
| Your Your First Computer | 8.95 |
| The CP/M Handbook | 14.95 |
| The PASCAL Handbook | 18.95 |
| Microprocessor Interfacing Techniques | 17.95 |

MICROCOMPUTER HARDWARE HANDBOOK

FROM ELCOMP — \$14.95

Over 800 pages of manufacturers data sheets on most commonly used IC's.

Includes:

- * TTL — 74/74LS and 74F
- * CMOS
- * Voltage Regulators
- * Memory — RAM, ROM, EPROM
- * CPU's — 6800, 6500, Z80, 8080, 8085, 8086/8
- * MPU support & interface — 6800, 6500, Z80, 8200, etc.

CABINET FOR 5 1/4" DISK DRIVE

- * COLOR MATCHES APPLE
- * FITS SHUGART

SPECIAL — \$29.95

BYPASS CAPS

| | |
|------------------|-----------|
| .01 UF DISC | 100/6.00 |
| .1 UF DISC | 100/8.00 |
| .1 UF MONOLITHIC | 100/15.00 |

WE NOW STOCK A COMPLETE LINE OF DISC, ELECTROLYTIC, MONOLITHIC AND TANTALUM CAPACITORS

RESISTORS

| | |
|--|----------|
| 1/4 WATT 5% CARBON FILM ALL STANDARD VALUES FROM 1 OHM TO 10 MEG OHM | |
| 50 PCS. SAME VALUE | .025 EA. |
| 100 PCS. SAME VALUE | .02 EA. |
| 1000 PCS. SAME VALUE | .015 EA. |

VISIT OUR RETAIL STORE — NEW HOURS —
M-W-F, 9-5
T-Th., 9-9 Sat. 11-3
PLEASE USE YOUR CUSTOMER NUMBER WHEN ORDERING

TERMS: For shipping include \$2 for UPS Ground or \$3 for UPS Blue Label Air. Items over 5 pounds require additional shipping charges. Foreign orders, include sufficient amount for shipping. There is a \$10 minimum order. Bay Area and Los Angeles Counties add 6% Sales Tax. Other California residents add 6% Sales Tax. We reserve the right to substitute manufacturer. Not responsible for typographical errors. Prices are subject to change without notice. We will match or beat any competitor's price provided it is not below our cost.

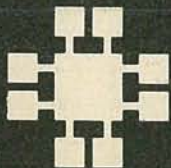

JDR MICRODEVICES, INC.

1224 S. Bascom Avenue
San Jose, CA 95128

800-538-5000 • 800-662-6279 (CA)
(408) 995-5430 • Telex 171-110

©1982 JDR MICRODEVICES, INC.

4116 16K DYNAMIC RAMS 250NS 8/\$11⁹⁵ SET

ALL MERCHANDISE 100% GUARANTEED!

CALL US FOR VOLUME QUOTES

NEW VIEWMAX 80

A Full Function 80 column card for Apple II* — Compare these features with any other:

- ★ 7x9 dot matrix; Upper and lower case with true descenders
- ★ Soft Video switch
- ★ Inverse video characters
- ★ Shift key support
- ★ Fully compatible with Apple* DOS, CP/M*, PASCAL, and most popular word processors

★ 2 YEAR WARRANTY

\$219⁹⁵

DISK DRIVE

- ★ Fully Apple* compatible
- ★ 35 Track — Will read half tracks!
- ★ Use with our controller (call for price) or with your Apple controller
- ★ Price includes case and cable — ready to plug in
- ★ Attractive cabinet matches Apple drive
- ★ 90-Day Warranty

\$299⁹⁵

JDR 16K RAMCARD

For Apple II*

- ★ Expand your 48K Apple to 64K
- ★ Fully compatible with Apple Language System — Use in place of Apple Language card
- ★ Provides extra memory for Visicalc™
- ★ Run PASCAL, FORTRAN, Integer Basic with appropriate software
- ★ Highest quality card features: gold edge connector, sockets for all IC's

NOW WITH 2 YEAR WARRANTY

ASSEMBLED & TESTED WITH WARRANTY **\$44⁹⁵**

KIT — INCLUDES ALL PARTS & INSTRUCTIONS... **\$40⁹⁵**

BARE PC CARD WITH INSTRUCTIONS..... **\$14⁹⁵**



JDR COOLING FAN

FOR YOUR APPLE II

- ★ Easy installation — no modification of Apple required
- ★ Eliminates overheating problems
- ★ Switch on front controls fan, Apple, and extra outlet
- ★ Rotron whisper fan is the quietest, most reliable on the market

\$69⁹⁵

ORDER TOLL FREE

800-538-5000

800-662-6279

(CALIFORNIA RESIDENTS)

IF YOU CAN FIND A PRICE LOWER ELSEWHERE, LET US KNOW AND WE'LL MEET OR BEAT THEIR PRICE! (SEE TERMS BELOW)

- ★ Computer managed inventory — virtually no back orders!
- ★ Very competitive prices!
- ★ Friendly staff!
- ★ Fast service — most orders shipped within 24 hours!

MONITORS

GREEN PHOSPHOR

NEC JB1201M **\$169⁰⁰**

ZENITH ZVM-121 **\$119⁰⁰**

COLOR

AMDEK COLOR 1 **\$335⁰⁰**

OKIDATA PRINTERS

- ★ 120 cps, 9x9 Dot Matrix
- ★ 50% faster than EPSON
- ★ Parallel and Serial interfaces are standard

ML-82A **\$479⁵⁰**

ML-83A **\$699⁹⁵**

ML-84 PARALLEL . . . **\$1059⁰⁰**

CALL FOR PRICES ON 82A TRACTOR OPTION AND 82A, 83A GRAPHICS OPTION. CABLES AND INTERFACE CARDS AVAILABLE

5 1/4" DISKETTES

ATHANA SS SD SOFT . . . **24.95**

MEMOREX SS SD SOFT **26.95**

VERBATIM SS DD SOFT **29.95**

VERBATIM 10 SECT. HARD **29.95**

NASHUA

TOP QUALITY — LOW PRICE!

Single Sided, Single Density Soft Sectored with Hub Ring

\$19.95 BOX OF 10

NEWPORT PROSTICK

- ★ Professional Quality Atari-Type Joystick
- ★ Extremely Rugged — Actual Arcade game Joystick
- ★ All parts are replaceable
- ★ 6 Month Warranty

\$31⁰⁰ EA \$59⁹⁵ PR



POWER SUPPLY \$39⁹⁵

MOUNTED ON PC BOARD
MANUFACTURED BY CONVER
+5 VOLT 4 AMP
±12 VOLT 1 AMP

SPECIAL THANKS TO
MARC AND AL FOR
THEIR HARD WORK
AND DEDICATION

ADVERTISING INDEX

RADIO-ELECTRONICS does not assume any responsibility for errors that may appear in the index below.

| Free Information Number | Page | |
|-------------------------|---|------------|
| 38 | Abex | 89 |
| 3 | Active Electronic Sales Corp | 109 |
| — | Advance Electronics | 22-23,77 |
| 50 | Advanced Computer Products | 121 |
| 53 | All Electronics Corp | 124 |
| 25 | AMC Sales | 102 |
| 91 | Anders Precision Instrument Co. | 89 |
| 15 | AP Products Inc. | 25 |
| 60 | Arizona Electronic Surplus | 120 |
| 12 | Beckman Instruments, Inc. | Cover III |
| 48 | Beta Electronics | 111 |
| 13 | Bishop Graphics, Inc. | 32 |
| 78 | B&K Precision Dynascan Corp Cover II | |
| — | Bullet Electronics | 110 |
| 19 | Cambridge Learning Inc. | 32 |
| — | C&D Electronics, Inc. | 124 |
| 66 | Chaney Electronics Inc. | 128 |
| — | CIE, Cleveland Institute of Electronics, Inc. | 34-37 |
| 30 | Command Productions | 85 |
| 7 | Communications Electronics | 2 |
| 8, 11, 12 | Component Express Inc. | 20,109,128 |
| 62 | Computer Products & Peripherals Unlimited | 109 |
| 55 | Concord Computer Products | 112 |
| 43 | Digi-Key Corporation | 122-123 |
| 61 | Digitron Electronic | 112 |
| 76 | Direct Video Sales | 85 |
| 51 | Dokay Computer Products, Inc. | 115 |
| 28 | Eico | 101 |
| 83 | Electronic Parts Supply, Inc. | 110 |
| 87,88 | Electronic Rainbow Inc. | 93,97 |
| 24 | Electronic Specialists, Inc. | 102 |
| — | Electronic Technology Today | 104 |
| 65 | Eto Electronics | 128 |
| 31 | Etronix | 91 |
| 27 | Firestik Antenna Company | 91 |
| — | Fordman | 29,31,33 |
| 41 | Formula International Inc. | 118,119 |
| 39 | Gamit | 88 |
| 82 | Gilco International, Inc. | 107 |
| 11 | Global Specialties Corp | 42 |
| — | Grantham College of Engineering .. | 101 |
| — | Graymark | 120 |
| 32 | Grove Enterprises | 88 |
| 86 | Hal-tronix | 116 |
| 70 | Heath Company | 26-27 |
| 85 | Hickok Electrical Instrument Co. | 81 |
| 67 | Illinois Audio | 102 |
| — | Information Unlimited | 116 |
| 42 | Jameco Electronics | 126-127 |
| 44 | JDR Microdevices, Inc. | 130-133 |
| 34 | Jenson Tools | 89 |
| 9 | Keithley Instruments, Inc. | 79 |
| 81 | Knapp | 114 |
| 23 | L-Com, Inc. | 97 |
| 40 | Mean Electronics | 89 |
| 79 | MFJ Enterprises, Inc. | 108 |
| — | Monarchy Engineering, Inc. | 114 |
| 63 | Mountain West | 124 |
| 56 | MP Systems | 114 |
| — | Mura Corp. | 116 |
| 33 | Nationwide G.H.Z. | 88 |
| — | Nesda | 134 |
| — | Netronics R&D Ltd. | 95 |
| 69 | Network Sales, Inc. | 112 |
| — | New Horizons | 87 |
| — | New-Tone Electronics | 15 |
| — | NRI Schools | 16-19 |
| — | NTS Schools | 68-71 |
| 5 | OK Industries Inc. | Cover IV |
| 68 | Omnitron Electronics | 93 |
| 36,93 | ORA Electronics | 89 |
| — | Paia Electronics, Inc. | 101 |
| 22 | Paladin Corp | 92 |
| 21 | Panavise Products, Inc. | 85 |
| 71 | Pete's Electronics Service Supply | 92 |
| — | PolyPaks Inc. | 117 |
| 57 | PPG Electronics Co., Inc. | 110 |
| 75 | Professional Aids Co. | 97 |
| 92,90 | Protecto Enterprises | 11,99 |
| 45 | Radio Shack | 129 |
| 46 | Ramsey Electronics, Inc. | 125 |
| 20 | Regency Electronics | 85 |
| — | RCA | 40-41 |
| 58 | R.F. Electronics | 120 |
| 14 | Sams Books | 30 |
| 64 | SCR Electronics Center | 108 |
| 6,89 | Sencore | 1 |
| — | Simple Simon Electronic Kits, Inc. | 83 |
| 16 | Sintec Co. | 24 |
| 52 | Solid State Sales | 108 |
| 59 | Spartan Electronics Inc. | 134 |
| 80 | Stavis Electronics, Inc. | 113 |
| 74 | Symmetric Sound Systems | 89 |
| 10 | Tab Books | 13 |
| —,17 | Tektronix | 7,38-39 |
| 35 | Telematic | 89 |
| 84 | Telton Corp. | 89 |
| 72 | Tiger Tech Electronic Components | 128 |
| 18 | Triton Marketing Corp | 28 |
| 73 | VIZ Mfg. Co. | 9 |
| 29 | Wersi | 101 |

ATTENTION TECHNICIANS

ARE YOU TIRED
of being

"only a serviceman"
or
"just a technician"?

THE LETTERS "CET"
AFTER YOUR NAME SPELLS
"PRIDE"

TRY IT.

Take pride in
your profession—
Decide to be a CET



For information about: ___ exam dates;
___ requirements; ___ study guides;
other _____

Send to: NESDA/ISCE
2708 W. Berry St.
Fort Worth, TX 76109
(817) 921-9101

Name _____
Address _____
City _____ St. _____ Zip _____

SPARTAN Electronics Inc.



CALL
(516) 499-9500
MAIL
6094 Jericho Tpke.
Commack, N.Y. 11725

CTC9R

Philips Remote Cable Converter



\$139.95

• Micro computer technology • Quartz controlled IC's lock in picture & prevent drift • 60 channel selections • Programmable time on & off • 24 hour LED digital clock • Favorite channel memory & recall plus scan • Wireless hand-held infrared transmitter system • Automatic fine tune • Adaptable to any brand television • One year warranty service.

CABLE TV ACCESSORIES

| | |
|----------------------|-------|
| 2 set coupler | 2.95 |
| 3 set coupler | 3.95 |
| 4 set coupler | 4.50 |
| F Connectors | .25 |
| Matching transformer | .99 |
| TV Game Switch | 3.95 |
| VHF-UHF AMP-28DB | 29.95 |

CHARACTER PHONES



Annie, Bugs Bunny,
Popeye, Beetle Bailey
\$59.95 Universal Dial
Touch Keyboard

Sleek Basic Phone

• Soft touch keyboard • Uni-
versal dial (works on all phone
lines) • 2 tone electronic ringer
• Wall hook (included) • Use
as desk or wall phone.
Four (4) memory phone —
\$26.95



\$19.95

SCOTCH DISKETTES



5 1/4 SSDD Soft Box 10 \$29.95
5 1/4 DSDD Soft Box 10 \$39.95

REFURBISHED MONITORS

9", 12", Commercial Grade
as low as **\$49.95**



EPSON PRINTERS



MX80 F/T
with Graftrax Plus
\$529.00

Portable IC Color Pattern Generator

MODEL 1210

• Generates 10 stable patterns including cross-
hatch 7 x 11 dot, gated rainbow and purity •
Compact for convenient field service use • Very
rugged aluminum and steel case for reliability
and shielding • Selects outputs on 3 channels •
Adjustable RF output into 75 ohm load for a
strong signal with any TV set • NTSC compatible



\$135.00

Jerrold 36 Channel Remote CATV Converter



w/on/off Fine Tuning \$94.95

40 Channel VHF to UHF Block Converter



28.95 Ea.
24.95 4 & up

Deluxe Version - Features fine tuning knob, matching X former & 2
cables \$38.95.

Dealers Welcome

Volume Discounts

| | | |
|---|-------------------|---------|
| Min. Order \$25.00 | to 75.00 | \$2.50 |
| International shipping Add'l. | 76.00 to 250.00 | \$4.50 |
| Prices subject to change without notice. | 251.00 to 500.00 | \$6.00 |
| COD 2.00 Extra | 501.00 to 750.00 | \$2.50 |
| *Add'l. shipping for monitors | 751.00 to 1000.00 | \$2.00 |
| | Over 1000.00 | \$12.50 |

Mon Th Tu W F Sa

499-9500 9-8 9-6 9:30-5

CIRCLE 59 ON FREE INFORMATION CARD



\$20 rebate on RMS models.
Expires March 31, 1983.

The Workaholics.

Beckman DMMs stay on the job when others call it quits. They're a hard-nosed breed of 3½ digit hand-held multimeters you can always count on for outstanding performance.

Staying power

Beckman DMMs work up to 2000 hours on a common 9V battery. That's ten times longer than other DMMs. And to prevent burnout on the job, Beckman DMMs can withstand 1500 Vdc loads and 6kV transients. Current ranges are protected with a 2A/250V fuse, and resistance ranges are protected up to 500 Vdc.

Easy to work with

No matter how hard they work, they're never hard to work with. Their single rotary switch makes function and range selection simple and sure. For your added convenience, most Beckman DMMs have built-in 10-Amp capability and Insta-ohms® continuity indication. That means you never have to carry an accessory shunt or wait for a continuity check.

SELECTION CHART

| MODEL | SPECIAL FEATURES | BASIC DC ACCURACY | INSTA-OHMS® | 10 AMPS | SUGGESTED RETAIL PRICE (U.S.) |
|------------|--|-------------------|-------------|---------|-------------------------------|
| Tech 300 | Basic six functions | 0.5% | | | \$120 |
| Tech 310 | Added features | 0.25% | ✓ | ✓ | 145 |
| Tech 310UL | UL-listed | 0.25% | ✓ | ✓ | 155 |
| Tech 320B | Audible continuity beeper | 0.1% | ✓ | ✓ | 189 |
| Tech 330 | High accuracy & true RMS (AC & DC) | 0.1% | ✓ | ✓ | 219 |
| HD-100 | Heavy duty (drop-proof, contamination-proof) | 0.25% | ✓ | | 169 |
| HD-110 | Heavy duty, plus 10 Amps | 0.25% | ✓ | ✓ | 189 |

And to make sure that the job is done right the first time, Beckman DMMs have superior RF shielding, and an impressive 22 Meg-ohm input impedance that reduces circuit loading to ensure accurate readings.

No matter how much the job demands, you can count on Beckman DMMs to see you through.

There's a Beckman DMM just right for every application. Use the selection chart to find the model best for you.

For a closer look at the workaholics, see your local Beckman distributor today. To locate the one nearest you, call or write Beckman Instruments, Inc., Instrumentation Operations, 210 S. Ranger Street, Brea, CA 92621. (714) 993-8803.

BECKMAN

LB-100

Lead Bender and Crimper

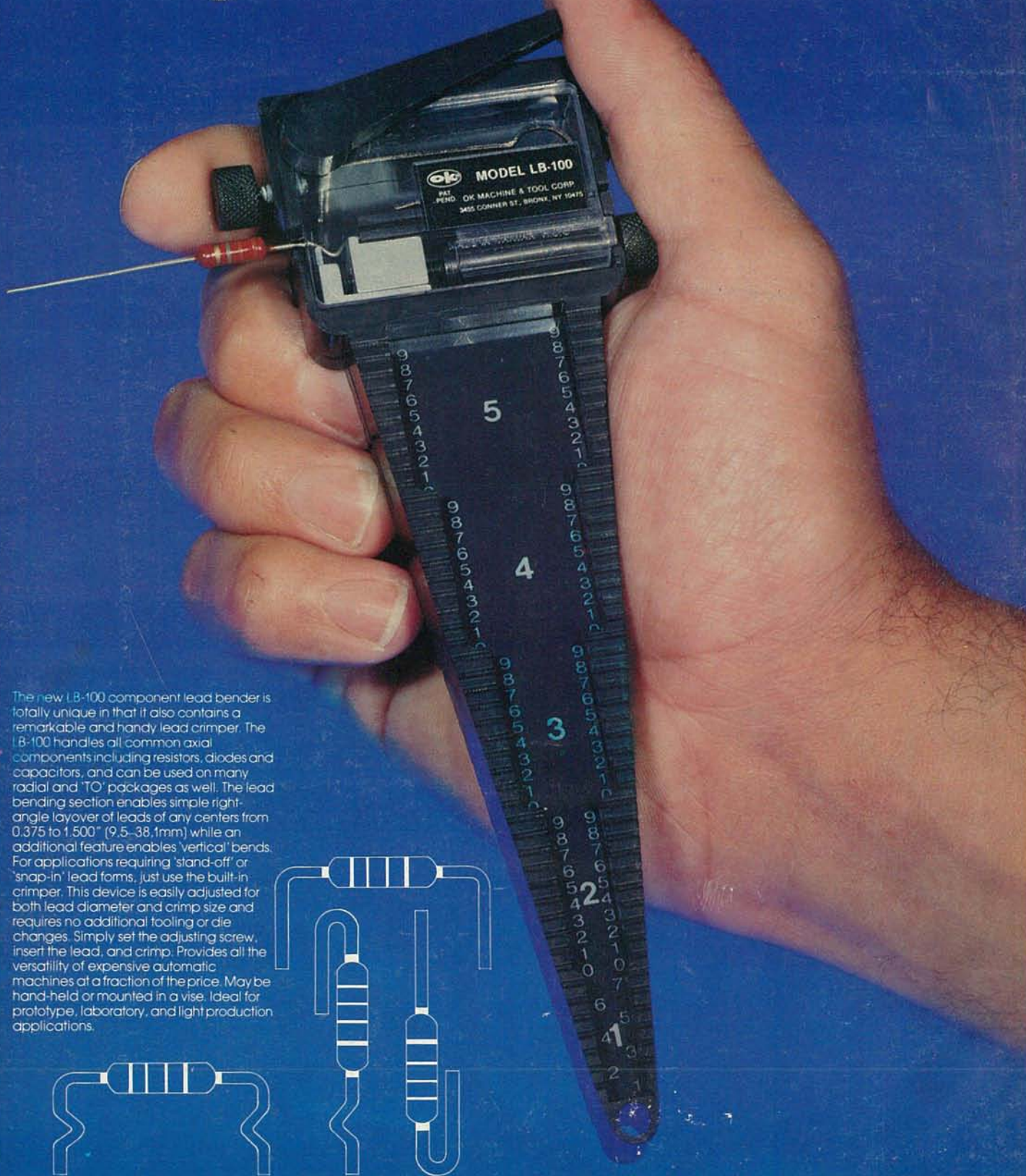

The new LB-100 component lead bender is totally unique in that it also contains a remarkable and handy lead crimper. The LB-100 handles all common axial components including resistors, diodes and capacitors, and can be used on many radial and 'TO' packages as well. The lead bending section enables simple right-angle layover of leads of any centers from 0.375 to 1.500" (9.5-38.1mm) while an additional feature enables 'vertical' bends. For applications requiring 'stand-off' or 'snap-in' lead forms, just use the built-in crimper. This device is easily adjusted for both lead diameter and crimp size and requires no additional tooling or die changes. Simply set the adjusting screw, insert the lead, and crimp. Provides all the versatility of expensive automatic machines at a fraction of the price. Maybe hand-held or mounted in a vise. Ideal for prototype, laboratory, and light production applications.

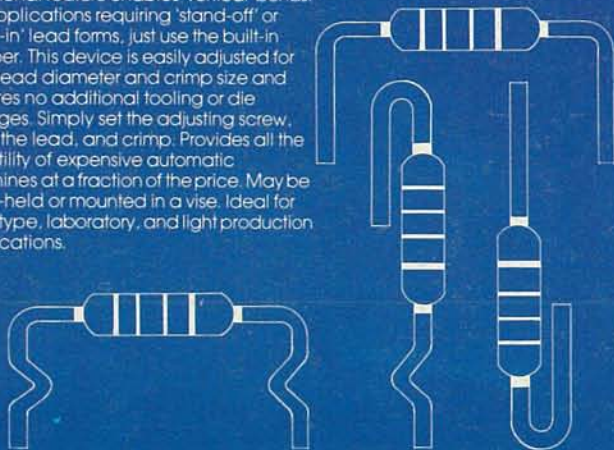

OK Machine & Tool Corporation
3455 Conner St., Bronx, N.Y. 10475 U.S.A.
Tel. (212) 994-6600 Telex 125091

CIRCLE 5 ON FREE INFORMATION CARD

Designed by C.P.A. Graphics and Design Ltd., Bournemouth, England. T. 202724613